

USER MANUAL

G-MASTER

LCD Monitor

ENGLISH

G-MASTER GB2783QSU

Thank you very much for choosing the iiyama LCD monitor.

We recommend that you take a few minutes to read this comprehensive manual carefully before installing and switching on the monitor. Please keep this manual in a safe place for your future reference.



Dear user, we congratulate you on the purchase of your iiyama LCD.

For details on warranty and locally used pixel policies that apply directly after installation of your product please check the iiyama website.

To report a fault, please contact your local support centre found at www.iiyama.com/service

Things to check before you call the iiyama information line

- | if the power cable is connected securely and turned on?
- | if the display has been turned on?
- | if the signal cable is connected securely and the correct input selected?
- | if the computer has been restarted with the display connected?
- | if the graphics card is correctly installed with the latest drivers possible?
- | if the correct native resolution has been selected via 'Display Properties'?
- | If the R/G/B signal configuration is correct?
- | if the displays On Screen Menu is shown?
- | if the correct brightness and contrast settings have been set?
- | if given display tolerances and compatibility have been considered?
- | if via the On Screen Menu you have performed a Factory Reset/Recall?

Before reporting the screen defect, please prepare the following information/evidence:

- | model number *
- | purchase receipt and serial number *
- | name and address for collection
- | telephone/fax number, for availability during the day
- | convenient collection date (date, time)
- | short description of the defect

Important Note:

If there is no fault found in the collected equipment after inspection, the transferring party shall incur charges for transport and administration.

If you have checked all of the above and there is still no picture, call our information line for assistance in your country.

* see the identification plate on the back of the case.

CE MARKING DECLARATION OF CONFORMITY

This LCD monitor complies with the requirements of the EC/EU Directive 2014/30/EU "EMC Directive", 2014/35/EU "Low Voltage Directive", 2009/125/EC "ErP Directive" and 2011/65/EU "RoHS Directive".

The electro-magnetic susceptibility has been chosen at a level that gives correct operation in residential areas, business and light industrial premises and small-scale enterprises, inside as well as outside of the buildings. All places of operation are characterised by their connection to the public low voltage power supply system.

IYAMA CORPORATION: Wijkemeerstraat 8, 2131 HA Hoofddorp, The Netherlands

Model No. : PL2783Q



We recommend recycling of used product. Please contact your dealer or iiyama service center. Recycle information is obtained via the Internet, using the address:
<http://www.iiyama.com>

You can access the Web page of different countries from there.

- We reserve the right to change specifications without notice.
- All trademarks used in this user manual are the property of their respective owners.

TABLE OF CONTENTS

| | |
|--|----|
| FOR YOUR SAFETY..... | 1 |
| SAFETY PRECAUTIONS..... | 1 |
| SPECIAL NOTES ON LCD MONITORS | 3 |
| CUSTOMER SERVICE | 3 |
| CLEANING | 3 |
| BEFORE YOU OPERATE THE MONITOR | 4 |
| FEATURES..... | 4 |
| CHECKING THE CONTENTS OF THE PACKAGE | 4 |
| WALL MOUNTING | 5 |
| FITTING AND REMOVAL OF BASE | 6 |
| CONTROLS AND CONNECTORS..... | 7 |
| CONNECTING YOUR MONITOR..... | 8 |
| COMPUTER SETTING | 9 |
| ADJUSTING THE HEIGHT AND THE VIEWING ANGLE | 9 |
| PANEL ROTATION | 9 |
| OPERATING THE MONITOR..... | 10 |
| ADJUSTMENT MENU CONTENTS | 11 |
| POWER MANAGEMENT FEATURE..... | 18 |
| TROUBLE SHOOTING | 19 |
| RECYCLING INFORMATION..... | 20 |
| APPENDIX | 21 |
| SPECIFICATIONS..... | 21 |
| DIMENSIONS..... | 22 |
| COMPLIANT TIMING | 22 |

FOR YOUR SAFETY

SAFETY PRECAUTIONS

WARNING

STOP OPERATING THE MONITOR WHEN YOU SENSE TROUBLE

If you notice any abnormal phenomena such as smoke, strange sounds or fumes, unplug the monitor and contact your dealer or iiyama service center immediately. Further use may be dangerous and can cause fire or electric shock.

NEVER REMOVE THE CABINET

High voltage circuits are inside the monitor. Removing the cabinet may expose you to the danger of fire or electric shock.

DO NOT PUT ANY OBJECT INTO THE MONITOR

Do not put any solid objects or liquids such as water into the monitor. In case of an accident, unplug your monitor immediately and contact your dealer or iiyama service center. Using the monitor with any object inside may cause fire, electric shock or damage.

INSTALL THE MONITOR ON A FLAT, STABLE SURFACE

The monitor may cause an injury if it falls or is dropped.

DO NOT USE THE MONITOR NEAR WATER

Do not use where water may be splashed or spilt onto the monitor as it may cause fire or electric shock.

OPERATE UNDER THE SPECIFIED POWER SUPPLY

Be sure to operate the monitor only with the specified power supply. Use of an incorrect voltage will cause malfunction and may cause fire or electric shock.

PROTECT THE CABLES

Do not pull or bend the power cable and signal cable. Do not place the monitor or any other heavy objects on the cables. If damaged, the cables may cause fire or electric shock.

ADVERSE WEATHER CONDITIONS

It is advisable not to operate the monitor during a heavy thunder storm as the continual breaks in power may cause malfunction. It is also advised not to touch the plug in these circumstances as it may cause electric shock.

CAUTION

INSTALLATION LOCATION

Do not install the monitor where sudden temperature changes may occur, or in humid, dusty or smoky areas as it may cause fire, electric shock or damage. You should also avoid areas where the sun shines directly on the monitor.

DO NOT PLACE THE MONITOR IN A HAZARDOUS POSITION

The monitor may topple and cause injury if not suitably located. Please also ensure that you do not place any heavy objects on the monitor, and that all cables are routed such that children may not pull the cables and possibly cause injury.

MAINTAIN GOOD VENTILATION

Ventilation slots are provided to keep the monitor from overheating. Covering the slots may cause fire. To allow adequate air circulation, place the monitor at least 10 cm (or 4 inches) from any walls. Do not remove the tilt stand when operating the monitor. Ventilation slots on the back of the cabinet will be blocked and the monitor may overheat if the stand is removed. This may cause fire or damage. Operating the monitor on its back, side, upside down or on a carpet or any other soft material may also cause damage.

DISCONNECT THE CABLES WHEN YOU MOVE THE MONITOR

When you move the monitor, turn off the power switch, unplug the monitor and be sure the signal cable is disconnected. If you do not disconnect them, it may cause fire or electric shock.

UNPLUG THE MONITOR

If the monitor is not in use for a long period of time it is recommended that it is left unplugged to avoid accidents.

HOLD THE PLUG WHEN DISCONNECTING

To disconnect the power cable or signal cable, always pull it by the plug. Never pull on the cable itself as this may cause fire or electric shock.

DO NOT TOUCH THE PLUG WITH WET HANDS

Pulling or inserting the plug with wet hands may cause electric shock.

WHEN YOU INSTALL THE MONITOR ON YOUR COMPUTER

Be sure the computer is strong enough to hold the weight of the monitor, otherwise, you may damage your computer.

CAREFUL! PROTECT YOUR HANDS AND FINGERS

- Be careful not to hurt your fingers or hands when you change the height or the angle.
- Injury can occur if care is not taken to avoid finger contact with the displays base when adjusting the height. (Just for height adjustable model.)

REMARK FOR 24/7 USAGE

This product is not specifically designed for 24/7 usage in all environments.

OTHERS

ERGONOMIC RECOMMENDATIONS

To eliminate eye fatigue, do not operate the monitor against a bright background or in a dark room. For optimal viewing comfort, the monitor should be just below eye level and 40-60 cm (16-24 inches) away from your eyes. When using the monitor over a prolonged time, a ten minute break every hour is recommended as looking at the screen continuously can cause eye strain.

SPECIAL NOTES ON LCD MONITORS

The following symptoms are normal with LCD monitors and do not indicate a problem.

- NOTE**
- When you first turn on the LCD monitor, the picture may not fit in the display area because of the type of computer that is used. In this case, adjust the picture position to the correct position.
 - You may find slightly uneven brightness on the screen depending on the desktop pattern you use.
 - Due to the nature of the LCD screen, an afterimage of the previous screen may remain after switching the image, when the same image is displayed for hours. In this case, the screen can be recovered slowly by changing the image or turning off the Power Switch for some hours.

CUSTOMER SERVICE

- NOTE**
- If you have to return your unit for service and the original packaging has been discarded, please contact your dealer or iiyama service center for advice or replacement packaging.

CLEANING

- WARNING**
- If you drop any materials or liquids such as water into the monitor when cleaning, unplug the power cable immediately and contact your dealer or iiyama service center.

- CAUTION**
- For safety reasons, turn off the power switch and unplug the monitor before you clean it.

- NOTE**
- To protect the LCD panel, do not scratch or rub the screen with a hard object.
 - Never use any of the following strong solvents. These will damage the cabinet and the LCD screen.

| | |
|------------------|--------------------------|
| Thinner | Spray-type cleaner |
| Benzine | Wax |
| Abrasive cleaner | Acid or Alkaline solvent |

- Touching the cabinet with any product made from rubber or plastic for a long time may cause degeneration or loss of paint on the cabinet.

CABINET Stains can be removed with a cloth lightly moistened with a mild detergent solvent. Then wipe the cabinet with a soft dry cloth.

LCD Periodic cleaning with a soft dry cloth is recommended.

SCREEN Don't use tissue paper etc. because these will damage the LCD screen.

BEFORE YOU OPERATE THE MONITOR

FEATURES

- ◆ Supports Resolutions up to 2560 × 1440
- ◆ High Contrast 1000:1 (Typical), Adv. Contrast Function Available / Brightness 350cd/m² (Typical) / Quick Response Time 5ms (Typical), 1ms (Gray to Gray)
- ◆ Supports AMD FreeSync™ technology (through DisplayPort-input)
- ◆ Flicker Free
- ◆ Blue Light Reducer
- ◆ Digital Character Smoothing
- ◆ USB3.0 Hub Function
- ◆ Stereo Speakers
2 × 2W Stereo Speakers
- ◆ Plug & Play VESA DDC2B Compliant
Windows® Vista/7/8/8.1/10 Compliant
- ◆ Power Management (VESA DPMS Compliant)
- ◆ VESA Mounting Standard (100mm×100mm) Compliant
- ◆ Keyhole for Security Lock

CHECKING THE CONTENTS OF THE PACKAGE

The following accessories are included in your package. Check to see if they are enclosed with the monitor. If anything is missing or damaged, please contact your local iiyama dealer or regional iiyama office.

- | | | |
|----------------|---------------------|---------------------------------|
| ■ Power Cable* | ■ HDMI Cable | ■ DisplayPort Cable |
| ■ USB Cable | ■ Stand-Base | ■ Screw for stand fixing (3pcs) |
| ■ Safety Guide | ■ Quick Start Guide | |

CAUTION

* The rating of the Power Cable enclosed in 120V area is 10A/125V. If you are using a power supply higher than this rating, then a power cable with a rating of 10A/250V must be used. However, all guarantees and warranties are void for any problems or damage caused by a power cable not supplied by iiyama.

WALL MOUNTING

- WARNING**
- When you use with the wall mounting, in consideration of thickness of the mounting stage, tighten the M4 Screw with washer which “L” length is 7mm to fasten the monitor. Using the screw longer than this may cause electric shock or damage because it may contact with the electrical parts inside the monitor.
 - Please check if the wall or ceiling can support the weight of the monitor before mounting it.

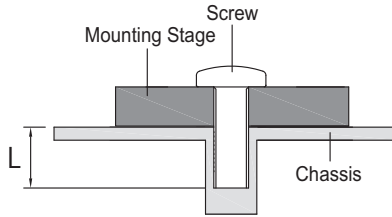

FITTING AND REMOVAL OF BASE

CAUTION

- Put the monitor on a stable surface. The monitor may cause injury or damage if it falls or is dropped.
- Do not give a strong impact to the monitor. It may cause damage.
- Unplug the monitor before removal or installation to avoid electric shock or damage.

<Installation>

- ① Put a piece of soft cloth on the table beforehand to prevent the monitor from being scratched.
Lay the monitor flat on a table with front face down.
- ② Hold the monitor and push the Stand-Base.
- ③ Use 'thumb screw' provided to secure base to monitor column.

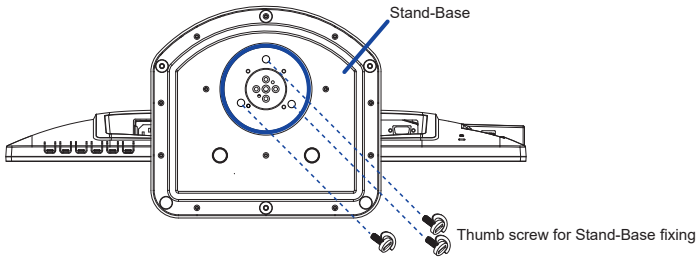

<Removal>

- ① Put a piece of soft cloth on the table beforehand to prevent the monitor from being scratched.
Lay the monitor flat on a table with front face down.
- ② Remove 'thumb screw' to remove base from monitor column.

<Stopper>

Put the monitor on a flat surface. Press the stopper at the back of the stand while pushing the monitor from the top. Careful attention is required as the monitor is sprung loaded and the stand may expand quickly.

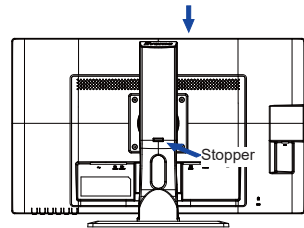

CONTROLS AND CONNECTORS

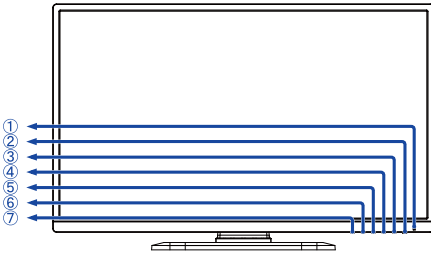

<Front>

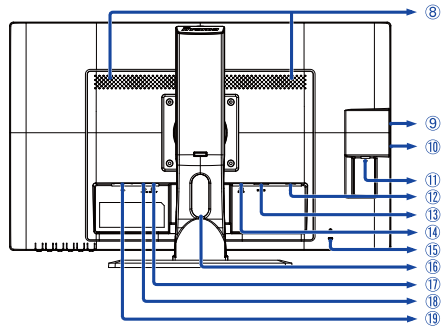

<Back>

① Power Indicator

NOTE Blue: Normal operation
Orange: Power Management

② Power Switch (⏻)

③ Menu / Select Button (MENU)

④ Scroll Up / Volume Button (▶ / 🔊)

⑤ Scroll Down / ECO Mode Button (◀ / ⓪)

⑥ Exit Button (EXIT)

⑦ Input Select Button (INPUT)

⑧ Speakers

⑨ USB Downstream Connector (🔌)

⑩ USB Downstream Connector (🔌)

⑪ USB Upstream Connector (🔌)

⑫ DisplayPort Connector (DP)

⑬ HDMI Connector (HDMI)

⑭ DVI-D 24pin Connector (DVI-D)

⑮ Keyhole for Security Lock

NOTE You can fasten a security lock and cable to prevent the monitor from being removed without your permission.

⑯ Cable Holes

⑰ Audio Connector (LINE OUT)

⑱ Audio Connector (LINE IN)

⑲ AC Connector (⎓ : Alternating current) (⎓)

CONNECTING YOUR MONITOR

- ① Ensure that both the computer and the monitor are switched off.
- ② Connect the computer to the monitor with the signal cable.
- ③ Connect the monitor to the audio equipment with the Audio Cable for computer when using the audio features.
- ④ Connect the Power Cable to the monitor first and then to the power supply.
- ⑤ Turn on your monitor and computer.

NOTE

- The signal cables used for connecting the computer and monitor may vary with the type of computer used. An incorrect connection may cause serious damage to both the monitor and the computer. The cable supplied with the monitor is for a standard connector. If a special cable is required please contact your local iiyama dealer or regional iiyama office.
- For connection to Macintosh computers, contact your local iiyama dealer or regional iiyama office for a suitable adaptor.
- Make sure you tighten the finger screws at each end of the signal cable.
- The Class I pluggable equipment Type A must be connected to protective earth.
- The socket-outlet shall be installed near the equipment and shall be easily accessible.
- Excessive sound pressure from ear/headphones can cause hearing damage/hearing loss.

[Example of Connection]

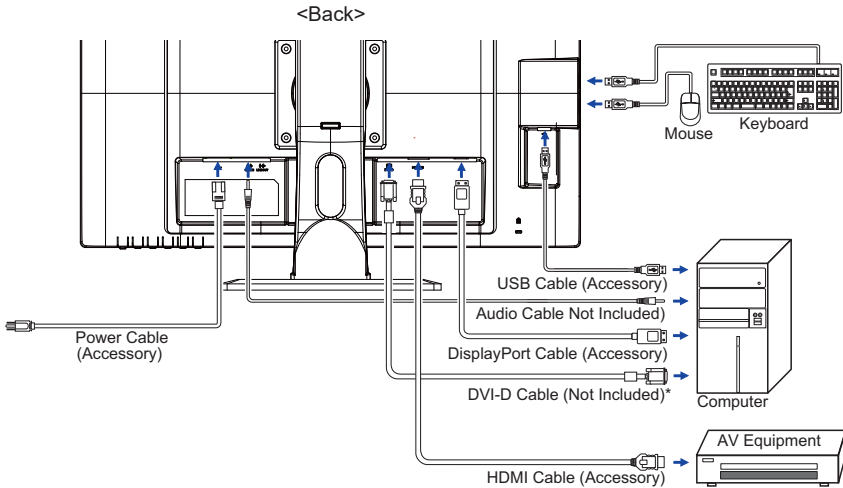

* DVI-D cable is not supplied with the monitor. If you use low quality DVI-D cable, it may cause a result of electro-magnetic interference. Please contact the iiyama Support Centre in your country if you wish to connect the monitor via the DVI input.

[Collect Cables]

- ① Put the cables through the cable hole.
- ② Collect cables at the back of the stand.

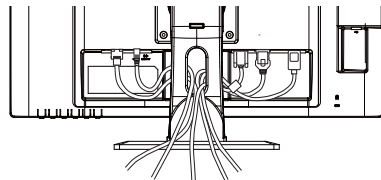

COMPUTER SETTING

■ Signal Timing

Change to the desired signal timing listed on page 22: COMPLIANT TIMING.

ADJUSTING THE HEIGHT AND THE VIEWING ANGLE

- For optimal viewing it is recommended to position yourself directly opposite to the full face of the monitor, then adjust the monitor's height and angle to your own preference.
- Hold the panel so that the monitor does not topple when you change the monitor's height or angle.
- You are able to adjust the monitor's height up to 130mm, angle up to 45 degrees right and left, 22 degrees upward and 5 degrees downward.

NOTE

- Do not touch the LCD screen when you change the height or the angle. It may cause damage or break the LCD screen.
- Careful attention is required not to catch your fingers or hands when you change the height or the angle.
- Injury can occur if care is not taken to avoid finger contact with the displays base when adjusting the height.

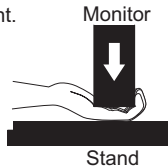
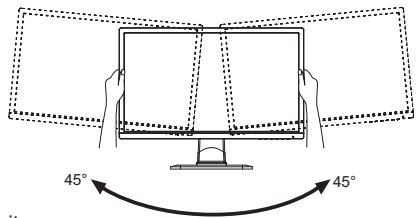
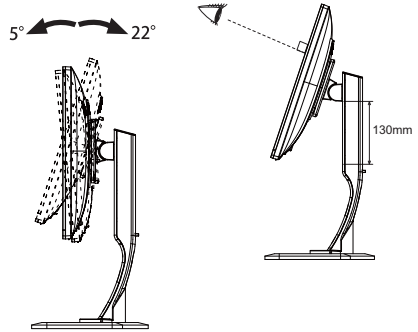

PANEL ROTATION

- ① Adjust the monitor's height.
- ② Rotate the panel 90 degrees.

Portrait: Turn clockwise.

Landscape: Turn counter clockwise.

NOTE

- Attempting to rotate without fully extending upward may cause damage to stand.
 - Video card for portrait display will be required for rotating the image on the screen.
- ③ Adjust the monitor's angle to your preference.

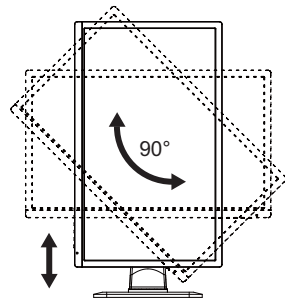

OPERATING THE MONITOR

To create the best picture, your iiyama LCD monitor has been preset at the factory with the COMPLIANT TIMING shown on page 22. You are also able to adjust the picture by following the button operation shown below.

- ① Press the ENTER Button to start the On Screen Display feature. There are additional Menu items which can be switched by using the ◀ / ▶ Buttons.
- ② Select the Menu item which contains the adjustment icon relating to the adjustment you want to make. Press the ENTER Button. Then, use the ◀ / ▶ Buttons to highlight the desired adjustment icon.
- ③ Press the ENTER Button again. Use the ◀ / ▶ Buttons to make the appropriate adjustment or setting.
- ④ Press the EXIT Button to leave the menu, and the settings you just made would be automatically saved.

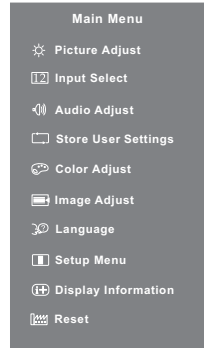

For example, to correct for OSD vertical position, select Menu item of Setup Menu and then press the ENTER Button. Then, select OSD Position by using the ◀ / ▶ Buttons. An adjustment page appears after you press the ENTER Button.

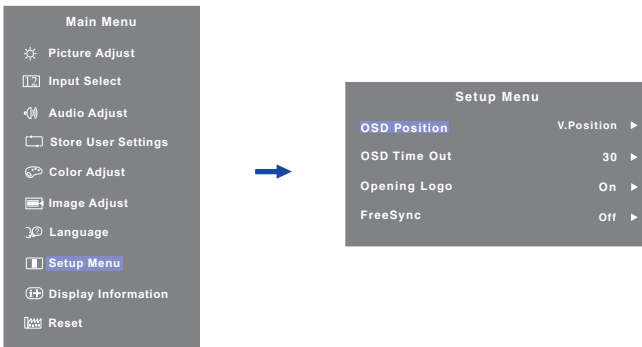

Then, select V.Position by using the ◀ / ▶ Buttons. Then, use the ◀ / ▶ Buttons to change the OSD vertical position settings. The OSD vertical position of the overall display should be changing accordingly while you are doing this.

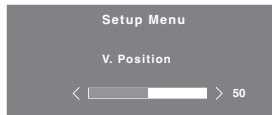





















Press the EXIT Button lastly, it ends, all changes are saved in the memory.

NOTE

- When button operations are aborted during adjustment, On-Screen Display disappears when the time set for the OSD Time Out has passed. Also, press the EXIT button to quickly turn off the On-Screen Display.
- Any changes are automatically saved in the memory when the On Screen Display disappears. Turning off the power should be avoided while using the Menu.
- All adjustments have only one setting which applies to all signal timings.

ADJUSTMENT MENU CONTENTS

|  Picture Adjust *3 | | | |
|--|--|--|--|
| Adjustment Item | Problem / Option | | Button to Press |
| Contrast *2 | Too dull Too intense | |     |
| Brightness *1,2,4 | Too dark Too bright | |     |
| Overdrive | Off / +1 / +2 It will improve the gray level response time of the LCD panel. A higher level results in a faster response time. | |     |
| Adv. Contrast | Off | Typical Contrast Ratio | |
| | On | Increased Contrast Ratio | |
| ECO Mode Direct | Off | Normal | |
| | Mode1 | Brightness of back-light is reduced. | |
| | Mode2 | Brightness of back-light is reduced more than 1. | |
| | Mode3 | Brightness of back-light is reduced more than 2. | |
| Blue Light Reducer Direct | Off | Typical | |
| | Mode1 | Blue light is reduced. | |
| | Mode2 | Blue light is reduced more than Mode1. | |
| | Mode3 | Blue light is reduced more than Mode2. | |
| Black Tuner | From -5 to +5 You can adjust Dark shades. | |     |
| Saturation | Too weak Too strong | |     |
| Gamma | You can set the Gamma. 1.8 / 2.2 / 2.6 | | |

*1 Adjust the Brightness when you are using the monitor in a dark room and feel the screen is too bright.

*2 Contrast and Brightness adjustments are disabled when Adv. Contrast mode is activated.

*3 Picture Adjust adjustment is disabled when i-Style Color is activated.

*4 Brightness adjustment is disabled when ECO Mode is activated.

Direct

You can skip the Menu items and display an adjustment scale directly by using the following button operations.

- ECO Mode : Press the  Button when the Menu is not displayed.
- Blue Light Reducer : Pressing and holding of the EXIT Button for 2-3 seconds when the Menu is not displayed.

12 Input Select







| Adjustment Item | Problem / Option | | Button to Press |
|-----------------|------------------|--|-----------------|
| Input Select | VGA | Select the Analog input. | |
| | HDMI | Select the Digital (HDMI) input. | |
| | DisplayPort | Select the Digital (DisplayPort) input. | |
| | Auto | Search for an available input source and select automatically. | |

NOTE Input source is fixed, not selected automatically when VGA, HDMI and DisplayPort which are selected.

Direct

You can skip the Menu items and display an adjustment scale directly by using the following button operations.

- Input Select : Press the INPUT Button when the Menu is not displayed.

| 🔊 Audio Adjust | | | |
|---|----------------------|--|--|
| Adjustment Item | Problem / Option | | Button to Press |
| Volume | Too soft Too loud | |     |
| Mute | Off | Return the sound volume to the previous level. | |
| | On | Turn off the sound temporarily. | |
| NOTE Mute On and Off are switched as follows by pressing the  Button successively. <div style="text-align: center;">  On → Off  </div> | | | |
| Digital Audio * | Line-In | Select the Line-In input. | |
| | HDMI | Select the HDMI input. | |
| | DisplayPort | Select the DisplayPort input. | |





* Suitable for HDMI/DisplayPort input only.

Direct







You can skip the Menu items and display an adjustment scale directly by using the following button operations.

- Volume : Press the  Button when the Menu is not displayed.

|  Store User Setting | | |
|---|------------------|---|
| Adjustment Item | Problem / Option | Button to Press |
| Store User Setting | User Mode 1 | Save the settings of the screen adjustment. |
| | User Mode 2 | Save the settings of the screen adjustment. |
| | User Mode 3 | Save the settings of the screen adjustment. |
| <p>NOTE You can memorize your customized monitor settings. The following settings can be memorized: Contrast, Brightness, Overdrive, Adv. Contrast, ECO mode, Volume, Mute, Color Adjust, i-Style Color, Sharpness, Black Tuner, Video Mode Adjust</p> | | |

|  Color Adjust | | |
|---|------------------|---|
| Adjustment Item | Problem / Option | Button to Press |
| Cool * | Bluish white | |
| Normal * | Greenish white | |
| Warm * | Reddish white | |
| User Color * | Red | Too weak   |
| | Green | |
| | Blue | Too strong   |













* Cool, Normal, Warm and User Color adjustments are disabled when i-Style Color or Blue Light Reducer is activated.

|  Image Adjust | | | |
|---|---|---|-----------------|
| Adjustment Item | Problem / Option | | Button to Press |
| i-Style Color * ¹ | Off | Return to a state set by color adjustment except i-Style Color. | |
| | Standard | For general windows environment and monitor default setting. | |
| | Sport Game | For Sports game environment. | |
| | FPS Game | For FPS game environment. | |
| | Strategy Game | For Strategy game environment. | |
| | Text | For text editing and viewing in a word processing environment. | |
| | User Mode 1 | Applies customized monitor settings. | |
| | User Mode 2 | Applies customized monitor settings. | |
| | User Mode 3 | Applies customized monitor settings. | |
| Sharpness | 1 2 3 4 5   You can change the picture quality from 1 to 5 (sharp to soft).   Press the  Button to change the picture quality in numerical order. Press the  Button to change the picture quality in reverse numerical order. | | |
| HDMI RGB Range | Full Range | For full-range color scale signal | |
| | Limited Range | For limited color scale signal | |
| Direct Drive Mode | Off | Typical | |
| | On | Reduce the input-lag. | |
| NOTE Changing Resolution and Refresh rate or turning Power Off/On might disable the Direct Drive function. | | | |
| Video Mode Adjust * ² | Full Screen | Expansion display | |
| | Aspect Ratio | Expansion display of Aspect | |
| | Dot by Dot | Display the picture dot by dot | |
| | 17 inch | Display the picture as 17 inch screen (5 : 4) | |
| | 19 inch | Display the picture as 19 inch screen (5 : 4) | |
| | 19.5 inch | Display the picture as 19.5 inch screen (16 : 9) | |
| | 21.5 inch | Display the picture as 21.5 inch screen (16 : 9) | |
| | 23 inch | Display the picture as 23 inch screen (16 : 9) | |
| | 23.6 inch | Display the picture as 23.6 inch screen (16 : 9) | |
| | 24 inch | Display the picture as 24 inch screen (16 : 9) | |

*¹ i-Style Color adjustment is disabled when Blue Light Reducer is activated.

*² Only HDMI/DisplayPort inputs.

|  Language | | | | |
|--|------------------|---------|------------|--------------------|
| Adjustment Item | Problem / Option | | | Button to Press |
| Language | English | English | Nederlands | Dutch |
| | Français | French | Česky | Czech |
| | Deutsch | German | Русский | Russian |
| | Italiano | Italian | 日本語 | Japanese |
| | Polski | Polish | 简体中文 | Simplified Chinese |
| | Español | Spanish | | |

|  Setup Menu | | | | |
|---|---|---|--|--|
| Adjustment Item | Problem / Option | | | Button to Press |
| OSD Position | H.Position | OSD is too left | |   |
| | | OSD is too right | |   |
| | V.Position | OSD is too low | |   |
| | | OSD is too high | |   |
| OSD Time Out | You can set the OSD display duration time between 5 and 30 seconds. | | |     |
| Opening Logo | Off | iiyama Logo does not display when the monitor is turned on. | | |
| | On | iiyama Logo displayed when the monitor is turned on. | | |
| FreeSync * | Off | The FreeSync function is turned off. | | |
| | On | Enable the FreeSync function. | | |

* Only DisplayPort input.



Display Information

Displays information regarding the current input signal coming from the graphic card in your computer.

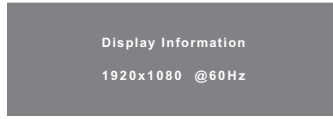
**NOTE**

See your graphic card user guide for more information about changing the resolution and refresh.



Reset

| Adjustment Item | Problem / Option Button to Press | |
|-----------------|----------------------------------|----------------------------------|
| Reset All | No | Return to Menu. |
| | Yes | Factory-preset data is restored. |

● Lock Mode

<OSD Menu>

1. The OSD lock will be activated by pressing the front button ENTER for about 10 seconds. If you try to access the OSD by pressing any of the buttons, message "OSD Locked" will appear on the screen.
2. The OSD lock will be deactivated by pressing the front button ENTER again for about 10 seconds.

<Power Switch>

1. The power switch lock will be activated by pressing the front button ◀ for about 10 seconds. Locking the power switch means that won't be able to turn off the Monitor while the power switch is locked. If presses the power switch message "Power Button Locked" will appear on the screen.
2. The power switch lock will be deactivated by pressing the front button ◀ again for about 10 seconds.

POWER MANAGEMENT FEATURE

The power management feature of this product complies with power saving requirement of VESA DPMS. When activated, it automatically reduces unnecessary power consumption of the monitor when your computer is not in use.

To use the feature, the monitor needs to be connected to a VESA DPMS compliant computer. There is a power management step the monitor takes as described below. The power management function, including any timer settings is configured by the operating system. Check your operating system manual for information on how this can be configured.

■ Power Management Mode

When the H-sync signal / V-sync signal / H and V sync signals from the computer are off, the monitor enters into Power Management Mode which reduces the power consumption to less than 0.5W. The screen becomes dark, and the power indicator turns to orange. From Power Management Mode, the image reappears in several seconds when either the keyboard or the mouse are touched again.

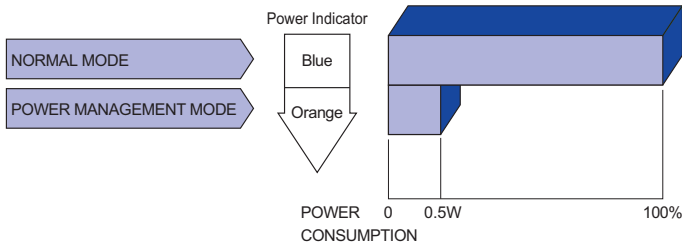

NOTE

- Even when using the power management mode, the monitor consumes electricity. Turn off the Power Switch whenever the monitor is not in use, during the night and weekends, to avoid unnecessary power consumption.
- It is possible that the video signal from the computer may be on while the H or V sync signal is missing. In this instance, the POWER MANAGEMENT feature may not work properly.

TROUBLE SHOOTING

If the monitor fails to operate correctly, please follow the steps below for a possible solution.

1. Perform the adjustments described in OPERATING THE MONITOR, depending on the problem you have. If the monitor does not get a picture, skip to 2.
2. Consult the following items if you cannot find an appropriate adjustment item in OPERATING THE MONITOR or if the problem persists.
3. If you are experiencing a problem which is not described below or you cannot correct the problem, discontinue using the monitor and contact your dealer or iiyama service center for further assistance.

| Problem | Check |
|--|--|
| ① The picture does not appear. (Power indicator does not light up.) (Power indicator is blue.) (Power indicator is orange.) | <input type="checkbox"/> The Power Cable is firmly seated in the socket. <input type="checkbox"/> The Power Switch is turned ON. <input type="checkbox"/> The AC socket is live. Please check with another piece of equipment. <input type="checkbox"/> If the blank screen saver is in active mode, touch the keyboard or the mouse. <input type="checkbox"/> Increase the Contrast and/or Brightness. <input type="checkbox"/> The computer is ON. <input type="checkbox"/> The Signal Cable is properly connected. <input type="checkbox"/> The signal timing of the computer is within the specification of the monitor. <input type="checkbox"/> If the monitor is in power management mode, touch the keyboard or the mouse. <input type="checkbox"/> The computer is ON. <input type="checkbox"/> The Signal Cable is properly connected. <input type="checkbox"/> The signal timing of the computer is within the specification of the monitor. |
| ② The screen is not synchronized. | <input type="checkbox"/> The Signal Cable is properly connected. <input type="checkbox"/> The signal timing of the computer is within the specification of the monitor. <input type="checkbox"/> The video output level of the computer is within the specification of the monitor. |
| ③ The screen position is not in the center. | <input type="checkbox"/> The signal timing of the computer is within the specification of the monitor. |
| ④ The screen is too bright or too dark. | <input type="checkbox"/> The video output level of the computer is within the specification of the monitor. |

Problem**Check**

- | | |
|---------------------------------------|--|
| ⑤ The screen is shaking. | <input type="checkbox"/> The power voltage is within the specification of the monitor. <input type="checkbox"/> The signal timing of the computer is within the specification of the monitor. |
| ⑥ No sound. | <input type="checkbox"/> The audio equipment (computer etc.) is ON. <input type="checkbox"/> The Audio Cable is properly connected. <input type="checkbox"/> The Volume is turned up. <input type="checkbox"/> The Mute is OFF. <input type="checkbox"/> The audio output level of the audio equipment is within the specification of the monitor. |
| ⑦ The sound is too loud or too quiet. | <input type="checkbox"/> The audio output level of the audio equipment is within the specification of the monitor. |
| ⑧ A strange noise is heard. | <input type="checkbox"/> The Audio Cable is properly connected. |

RECYCLING INFORMATION

For better environment protection please don't dispose your monitor.
 Please visit our web site: www.iiyama.com/recycle for monitor recycling.

APPENDIX

Design and specifications are subject to change without prior notice.

SPECIFICATIONS

| | | |
|------------------------------|---|---|
| Size Category | 27" | |
| LCD Panel | Panel Technology | TN |
| | Size | Diagonal: 27" (68.5cm) |
| | Pixel pitch | 0.233mm H × 0.233mm V |
| | Brightness | 350cd/m ² (Typical) |
| | Contrast ratio | 1000 : 1 (Typical), Adv. Contrast Function Available |
| | Viewable angle | Right / Left : 85 degrees each, Up / Down : 80 degrees each (Typical) |
| | Response time | 5ms (Typical), 1ms (Gray to Gray) |
| Display Colours | 16,777,216 | |
| Sync Frequency | DVI: Horizontal: 30.0-90.0kHz, Vertical: 55-75Hz HDMI: Horizontal: 30.0-90.0kHz, Vertical: 55-75Hz DisplayPort(without FreeSync) : Horizontal: 30.0-115.0kHz, Vertical: 50-75Hz DisplayPort(with FreeSync): Horizontal: 30.0-115.0kHz, Vertical: 48-75Hz | |
| Native Resolution | 2560 × 1440, 3.7 MegaPixels | |
| Support max. resolution | DVI: 2560 × 1440 60Hz HDMI: 2560 × 1440 60Hz DisplayPort(without FreeSync) : 2560 × 1440 70Hz DisplayPort(with FreeSync): 2560 × 1440 70Hz | |
| Input Connector | DVI-D 24 pin, HDMI, DisplayPort | |
| Plug & Play | VESA DDC2B™ | |
| Input Video Signal | DVI (Digital Visual Interface Standard Rev.1.0) compliance HDMI, DisplayPort | |
| USB Standard | USB3.0 | |
| Number of USB Ports | 1 Upstream : Series B | |
| Connector shape | 2 Downstream : Series A | |
| Input Audio Connector | ø 3.5mm mini jack (Stereo) | |
| Input Audio Signal | 1.0Vrms maximum | |
| Output Audio Connector | ø 3.5mm mini jack (Stereo) | |
| Speakers | 2W × 2 (Stereo speakers) | |
| Maximum Screen Size | 596.7mm W × 335.7mm H / 23.5" W × 13.2" H | |
| Power Source | 100-240VAC, 50/60Hz, 1.5A | |
| Power Consumption* | 44W typical, Power management mode: 0.5W maximum Energy Efficiency Class: B | |
| Dimensions / Net Weight | 622.5 × 400.5 - 530.5 × 230.0mm / 24.5 × 15.8 - 20.9 × 9.1" (W×H×D) 6.1kg / 13.44lbs | |
| Tilt Angle | Upward: 22 degrees Downward: 5 degrees, Left/Right: 45 degrees each | |
| Environmental Considerations | Operating: Temperature 5 to 35°C / 41 to 95°F Humidity 10 to 80% (No condensation) Storage: Temperature -20 to 60°C / -4 to 140°F Humidity 5 to 85% (No condensation) | |
| Approvals | CE, TÜV-GS, CU | |

NOTE * Audio/USB equipment is not connected.

DIMENSIONS

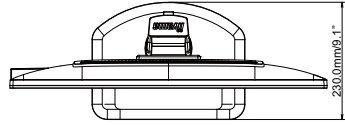
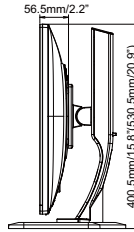
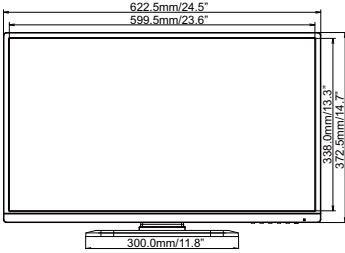

() : Maximum adjustment range

COMPLIANT TIMING

| Video Mode | | Horizontal Frequency | Vertical Frequency | Dot Clock |
|------------------|---------------------|----------------------|--------------------|------------|
| VESA | VGA 640 × 480 | 31.469kHz | 59.940Hz | 25.175MHz |
| | SVGA 800 × 600 | 37.879kHz | 60.317Hz | 40.000MHz |
| | XGA 1024 × 768 | 48.363kHz | 60.004Hz | 65.000MHz |
| | SXGA 1280 × 1024 | 63.981kHz | 60.020Hz | 108.000MHz |
| | UXGA 1600 × 1200 | 75.000kHz | 60.000Hz | 162.000MHz |
| | WSXGA+ 1680 × 1050 | 65.290kHz | 60.000Hz | 146.250MHz |
| | Full HD 1920 × 1080 | 67.500kHz | 60.000Hz | 148.500MHz |
| | QWXGA 2048 × 1152 | 71.584kHz | 60.000Hz | 197.000MHz |
| WQHD 2560 × 1440 | | 88.787kHz | 59.951Hz | 241.500MHz |
| | | 104.045kHz | 69.923Hz | 274.680MHz |

*1

*1

*2

NOTE *1 DVI : Use DVI-D dual-link signal cable.

*2 DisplayPort input only.