

Industrial 2 Port Gigabit PoE+ Injector 48V / 30W - Wall-Mountable

POEINJ2GI



*actual product may vary from photos

DE: Bedienungsanleitung - de.startech.com

FR: Guide de l'utilisateur - fr.startech.com

ES: Guía del usuario - es.startech.com

IT: Guida per l'uso - it.startech.com

NL: Gebruiksaanwijzing - nl.startech.com

PT: Guia do usuário - pt.startech.com

For the most up-to-date information, please visit: www.startech.com

FCC Compliance Statement

This equipment has been tested and found to comply with the limits for a Class A digital device, pursuant to part 15 of the FCC Rules. These limits are designed to provide reasonable protection against harmful interference in a residential installation. This equipment generates, uses and can radiate radio frequency energy and, if not installed and used in accordance with the instructions, may cause harmful interference to radio communications. However, there is no guarantee that interference will not occur in a particular installation. If this equipment does cause harmful interference to radio or television reception, which can be determined by turning the equipment off and on, the user is encouraged to try to correct the interference by one or more of the following measures:

- Reorient or relocate the receiving antenna.
- Increase the separation between the equipment and receiver.
- Connect the equipment into an outlet on a circuit different from that to which the receiver is connected.
- Consult the dealer or an experienced radio/TV technician for help.

This device complies with part 15 of the FCC Rules. Operation is subject to the following two conditions: (1) This device may not cause harmful interference, and (2) this device must accept any interference received, including interference that may cause undesired operation.

Changes or modifications not expressly approved by StarTech.com could void the user's authority to operate the equipment.

Use of Trademarks, Registered Trademarks, and other Protected Names and Symbols

This manual may make reference to trademarks, registered trademarks, and other protected names and/or symbols of third-party companies not related in any way to StarTech.com. Where they occur these references are for illustrative purposes only and do not represent an endorsement of a product or service by StarTech.com, or an endorsement of the product(s) to which this manual applies by the third-party company in question. Regardless of any direct acknowledgement elsewhere in the body of this document, StarTech.com hereby acknowledges that all trademarks, registered trademarks, service marks, and other protected names and/or symbols contained in this manual and related documents are the property of their respective holders.

Table of Contents

Introduction	2
Packaging Contents	2
System Requirements.....	2
Product Overview	2
Terminal Block Power Connector	3
LED Indicators.....	3
Pinout	4
Din Rail / Wall Bracket Installation.....	6
Hardware Installation	6
Technical Support	7
Warranty Information	7

Introduction

Packaging Contents

- 1 x 2 Port PoE Injector
- 1 x DIN Rail Bracket w/ Screws
- 2 x Wall Mount Brackets w/ Screws
- 1 x 4-Pin Terminal Block
- 2 x Dust Covers (RJ-45)
- 1 x Power Cable w/ Female DC Jack
- 1 x Instruction Manual

System Requirements

- RJ45 terminated Cat5 or higher Ethernet cabling
- 10/100/1000 Mbps compatible Ethernet network
- 50-57 V DC Power Supply

Product Overview

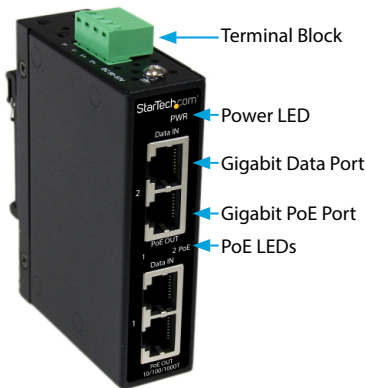

Terminal Block Power Connector

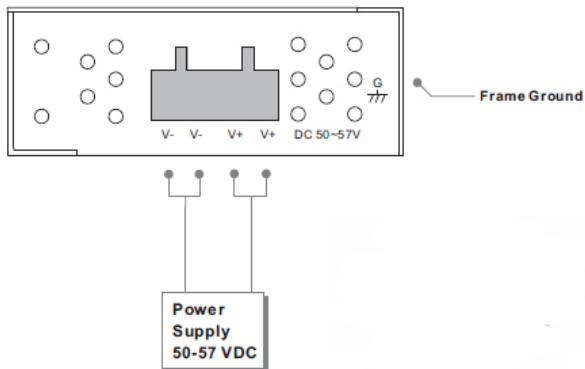

LED Indicators

PWR (Green)	Solid: Power is connected and functioning
PoE LED x 2 (Blue)	Solid: PoE device detected
	Flashing: Detecting PoE device
	Off: No PoE device detected

Pinout

1000Base-T

■ RJ45 (8-pin, MDI) Port Pinouts

Pin	MDI
1	BI_DA+
2	BI_DA-
3	BI_DB+
4	BI_DC+
5	BI_DC-
6	BI_DB-
7	BI_DD+
8	BI_DD-

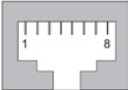

■ RJ45 (8-pin, MDI-X) Port Pinouts

Pin	MDI-X
1	BI_DB+
2	BI_DB-
3	BI_DA+
4	BI_DD+
5	BI_DD-
6	BI_DA-
7	BI_DC+
8	BI_DC-

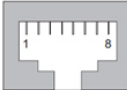

RJ-45 Input (Data Only)			RJ-45 Output (Data and Power)	
	Symbol	Description	Symbol	Description
1	BI_DA+	Data BI_DA+	BI_DA+ (Vdc+)	Data BI_DA+ and Feeding power (+)
2	BI_DA-	Data BI_DA-	BI_DA- (Vdc+)	Data BI_DA- and Feeding power (+)
3	BI_DB+	Data BI_DB+	BI_DB+ (Vdc-)	Data BI_DB+ and Feeding power (-)
4	BI_DC+	Data BI_DC+	BI_DC+	Data BI_DC+
5	BI_DC-	Data BI_DC-	BI_DC-	Data BI_DC-
6	BI_DB-	Data BI_DB-	BI_DB- (Vdc-)	Data BI_DB- and Feeding power (-)
7	BI_DD+	Data BI_DD+	BI_DD+	Data BI_DD+
8	BI_DD-	Data BI_DD-	BI_DD-	Data BI_DD-

10/100Base-TX

■ RJ45 (8-pin, MDI) Port Pinouts

Pin	Single
1	Tx+
2	Tx-
3	Rx+
6	Rx-

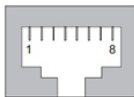

■ RJ45 (8-pin, MDI-X) Port Pinouts

Pin	Single
1	Rx+
2	Rx-
3	Tx+
6	Tx-

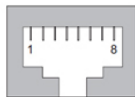

RJ-45 Input (Data Only)			RJ-45 Output (Data and Power)	
Symbol	Description		Symbol	Description
1	Rx+	Data Receive	Rx+ (Vdc+)	Data Receive and Feeding power (+)
2	Rx-	Data Receive	Rx- (Vdc+)	Data Receive and Feeding power (+)
3	Tx+	Data Transmit	Tx+ (Vdc-)	Data Transmit and Feeding power (-)
4	NC	Not connected	NC	Not connected
5	NC	Not connected	NC	Not connected
6	Tx-	Data Transmit	Tx- (Vdc-)	Data Transmit and Feeding power (-)
7	NC	Not connected	NC	Not connected
8	NC	Not connected	NC	Not connected

Note: pins 3 and 6 (-Vdc) should not be shorted to ground

Din Rail / Wall Bracket Installation

If you are mounting the POEINJ2GI product onto either a DIN Rail or to a wall, you will first need to attach the appropriate bracket(s) to the device as shown below.

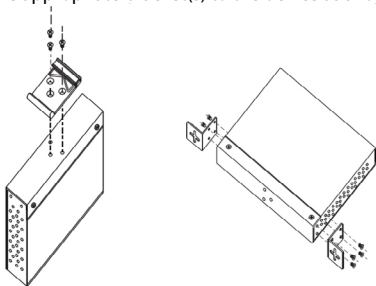

Hardware Installation

1. Connect an Ethernet cable from the desired source network device (i.e. computer, router, switch, etc.) to the "Data In" RJ45 connectors of the POEINJ2GI unit. These can be connected to the same router/switch, or a different one depending on your application.
2. Connect the terminal block power source to the POEINJ2GI unit.
3. Connect an RJ45 terminated Ethernet cable to the "PoE Out" connectors on the POEINJ2GI unit. The other end of the cable will either connect directly to a PoE+ / PoE-compliant device, or to a POE Splitter device to separate data and power.

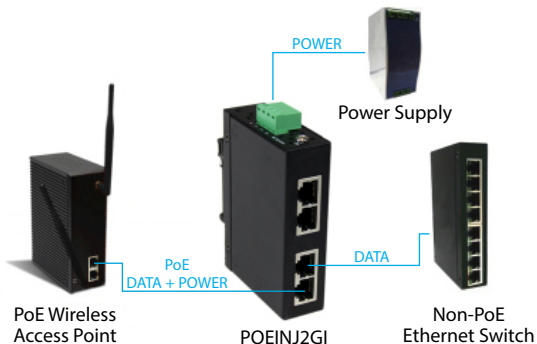

Technical Support

StarTech.com's lifetime technical support is an integral part of our commitment to provide industry-leading solutions. If you ever need help with your product, visit www.startech.com/support and access our comprehensive selection of online tools, documentation, and downloads.

For the latest drivers/software, please visit www.startech.com/downloads

Warranty Information

This product is backed by a two year warranty.

In addition, StarTech.com warrants its products against defects in materials and workmanship for the periods noted, following the initial date of purchase. During this period, the products may be returned for repair, or replacement with equivalent products at our discretion. The warranty covers parts and labor costs only. StarTech.com does not warrant its products from defects or damages arising from misuse, abuse, alteration, or normal wear and tear.

Limitation of Liability

In no event shall the liability of StarTech.com Ltd. and StarTech.com USA LLP (or their officers, directors, employees or agents) for any damages (whether direct or indirect, special, punitive, incidental, consequential, or otherwise), loss of profits, loss of business, or any pecuniary loss, arising out of or related to the use of the product exceed the actual price paid for the product. Some states do not allow the exclusion or limitation of incidental or consequential damages. If such laws apply, the limitations or exclusions contained in this statement may not apply to you.

Hard-to-find made easy. At StarTech.com, that isn't a slogan. It's a promise.

StarTech.com is your one-stop source for every connectivity part you need. From the latest technology to legacy products — and all the parts that bridge the old and new — we can help you find the parts that connect your solutions.

We make it easy to locate the parts, and we quickly deliver them wherever they need to go. Just talk to one of our tech advisors or visit our website. You'll be connected to the products you need in no time.

Visit www.startech.com for complete information on all StarTech.com products and to access exclusive resources and time-saving tools.

StarTech.com is an ISO 9001 Registered manufacturer of connectivity and technology parts. StarTech.com was founded in 1985 and has operations in the United States, Canada, the United Kingdom and Taiwan servicing a worldwide market.