

USER MANUAL

ProLite

LCD Monitor

ENGLISH

ProLite T1531SR
ProLite T1731SR
ProLite T1931SR
ProLite T1532SR
ProLite T1531SAW
ProLite T1731SAW
ProLite T1931SAW

Thank you very much for choosing the iiyama LCD monitor.

We recommend that you take a few minutes to read this comprehensive manual carefully before installing and switching on the monitor. Please keep this manual in a safe place for your future reference.



Dear user, we congratulate you on the purchase of your iiyama LCD.

For details on warranty and locally used pixel policies that apply directly after installation of your product please check the iiyama website.

To report a fault, please contact your local support centre found at www.iiyama.com/service

Things to check before you call the iiyama information line

- | if the power cable is connected securely and turned on?
- | if the display has been turned on?
- | if the signal cable is connected securely and the correct input selected?
- | if the computer has been restarted with the display connected?
- | if the graphics card is correctly installed with the latest drivers possible?
- | if the correct native resolution has been selected via 'Display Properties'?
- | If the R/G/B signal configuration is correct?
- | if the displays On Screen Menu is shown?
- | if the correct brightness and contrast settings have been set?
- | if given display tolerances and compatibility have been considered?
- | if via the On Screen Menu you have performed a Factory Reset/Recall?

Before reporting the screen defect, please prepare the following information/evidence:

- | model number *
- | purchase receipt and serial number *
- | name and address for collection
- | telephone/fax number, for availability during the day
- | convenient collection date (date, time)
- | short description of the defect

Important Note:

If there is no fault found in the collected equipment after inspection, the transferring party shall incur charges for transport and administration.

If you have checked all of the above and there is still no picture, call our information line for assistance in your country.

* see the identification plate on the back of the case.

CE MARKING DECLARATION OF CONFORMITY

This LCD monitor complies with the requirements of the EC Directive 2004/108/EC "EMC Directive", 2006/95/EC "Low Voltage Directive" and 2009/125/EC "ErP Directive".

The electro-magnetic susceptibility has been chosen at a level that gives correct operation in residential areas, business and light industrial premises and small-scale enterprises, inside as well as outside of the buildings. All places of operation are characterised by their connection to the public low voltage power supply system.

IYAMA CORPORATION: Breguetlaan 8, 1438BC Oude Meer The Netherlands



We recommend recycling of used product. Please contact your dealer or iiyama service center. Recycle information is obtained via the Internet, using the address:
<http://www.iiyama.com>

You can access the Web page of different countries from there.

- We reserve the right to change specifications without notice.
- All trademarks used in this user manual are the property of their respective owners.

TABLE OF CONTENTS

FOR YOUR SAFETY.....	1
SAFETY PRECAUTIONS	1
SPECIAL NOTES ON LCD MONITORS.....	3
CUSTOMER SERVICE.....	3
CLEANING.....	3
BEFORE YOU OPERATE THE MONITOR	4
FEATURES	4
CHECKING THE CONTENTS OF THE PACKAGE.....	4
SPECIAL NOTES ON TOUCH PANEL.....	5
WALL MOUNTING.....	5
CONTROLS AND CONNECTORS	6
CONNECTING YOUR MONITOR.....	7
COMPUTER SETTING.....	8
ADJUSTING THE VIEWING ANGLE	8
OPERATING THE MONITOR.....	9
ADJUSTMENT MENU CONTENTS	10
SCREEN ADJUSTMENTS.....	14
POWER MANAGEMENT FEATURE	17
TROUBLE SHOOTING	18
RECYCLING INFORMATION.....	19
APPENDIX	20
SPECIFICATIONS : ProLite T1531SR	20
SPECIFICATIONS : ProLite T1531SAW	21
SPECIFICATIONS : ProLite T1532SR	22
SPECIFICATIONS : ProLite T1731SR.....	23
SPECIFICATIONS : ProLite T1731SAW.....	24
SPECIFICATIONS : ProLite T1931SR	25
SPECIFICATIONS : ProLite T1931SAW	26
DIMENSIONS : ProLite T1531SR / ProLite T1531SAW / ProLite T1532SR ...	27
DIMENSIONS : ProLite T1731SR / ProLite T1731SAW	27
DIMENSIONS : ProLite T1931SR / ProLite T1931SAW	27
COMPLIANT TIMING.....	28

FOR YOUR SAFETY

SAFETY PRECAUTIONS

WARNING

STOP OPERATING THE MONITOR WHEN YOU SENSE TROUBLE

If you notice any abnormal phenomena such as smoke, strange sounds or fumes, unplug the monitor and contact your dealer or iiyama service center immediately. Further use may be dangerous and can cause fire or electric shock.

NEVER REMOVE THE CABINET

High voltage circuits are inside the monitor. Removing the cabinet may expose you to the danger of fire or electric shock.

DO NOT PUT ANY OBJECT INTO THE MONITOR

Do not put any solid objects or liquids such as water into the monitor. In case of an accident, unplug your monitor immediately and contact your dealer or iiyama service center. Using the monitor with any object inside may cause fire, electric shock or damage.

INSTALL THE MONITOR ON A FLAT, STABLE SURFACE

The monitor may cause an injury if it falls or is dropped.

DO NOT USE THE MONITOR NEAR WATER

Do not use where water may be splashed or spilt onto the monitor as it may cause fire or electric shock.

OPERATE UNDER THE SPECIFIED POWER SUPPLY

Be sure to operate the monitor only with the specified power supply. Use of an incorrect voltage will cause malfunction and may cause fire or electric shock.

PROTECT THE CABLES

Do not pull or bend the power cable and signal cable. Do not place the monitor or any other heavy objects on the cables. If damaged, the cables may cause fire or electric shock.

ADVERSE WEATHER CONDITIONS

It is advisable not to operate the monitor during a heavy thunder storm as the continual breaks in power may cause malfunction. It is also advised not to touch the plug in these circumstances as it may cause electric shock.

CAUTION

INSTALLATION LOCATION

Do not install the monitor where sudden temperature changes may occur, or in humid, dusty or smoky areas as it may cause fire, electric shock or damage. You should also avoid areas where the sun shines directly on the monitor.

DO NOT PLACE THE MONITOR IN A HAZARDOUS POSITION

The monitor may topple and cause injury if not suitably located. Please also ensure that you do not place any heavy objects on the monitor, and that all cables are routed such that children may not pull the cables and possibly cause injury.

MAINTAIN GOOD VENTILATION

Ventilation slots are provided to keep the monitor from overheating. Covering the slots may cause fire. To allow adequate air circulation, place the monitor at least 10 cm (or 4 inches) from any walls. Do not remove the tilt stand when operating the monitor. Ventilation slots on the back of the cabinet will be blocked and the monitor may overheat if the stand is removed. This may cause fire or damage. Operating the monitor on its back, side, upside down or on a carpet or any other soft material may also cause damage.

DISCONNECT THE CABLES WHEN YOU MOVE THE MONITOR

When you move the monitor, turn off the power switch, unplug the monitor and be sure the signal cable is disconnected. If you do not disconnect them, it may cause fire or electric shock.

UNPLUG THE MONITOR

If the monitor is not in use for a long period of time it is recommended that it is left unplugged to avoid accidents.

HOLD THE PLUG WHEN DISCONNECTING

To disconnect the power cable or signal cable, always pull it by the plug. Never pull on the cable itself as this may cause fire or electric shock.

DO NOT TOUCH THE PLUG WITH WET HANDS

Pulling or inserting the plug with wet hands may cause electric shock.

WHEN YOU INSTALL THE MONITOR ON YOUR COMPUTER

Be sure the computer is strong enough to hold the weight of the monitor, otherwise, you may damage your computer.

DO NOT PUT FLOPPY DISKS NEAR THE SPEAKERS

Magnetically recorded data, such as on a floppy disk, may become corrupted by the magnetic field produced by the speakers if the disks are placed on or near the speakers.

OTHERS

ERGONOMIC RECOMMENDATIONS

To eliminate eye fatigue, do not operate the monitor against a bright background or in a dark room. For optimal viewing comfort, the monitor should be just below eye level and 40-60 cm (16-24 inches) away from your eyes. When using the monitor over a prolonged time, a ten minute break every hour is recommended as looking at the screen continuously can cause eye strain.

SPECIAL NOTES ON LCD MONITORS

The following symptoms are normal with LCD monitors and do not indicate a problem.

NOTE

- When you first turn on the LCD monitor, the picture may not fit in the display area because of the type of computer that is used. In this case, adjust the picture position to the correct position.
- Due to the nature of the backlight, the screen may flicker during initial use. Turn off the Power Switch and then turn it on again to make sure the flicker disappears.
- You may find slightly uneven brightness on the screen depending on the desktop pattern you use.
- Due to the nature of the LCD screen, an afterimage of the previous screen may remain after switching the image, when the same image is displayed for hours. In this case, the screen is recovered slowly by changing the image or turning off the Power Switch for hours.
- Contact your dealer or iiyama service center for the backlight replacement when the screen is dark, flickering or not lighting up. Never attempt to replace it by yourself.

CUSTOMER SERVICE

NOTE

- The fluorescent light used in the LCD monitor may have to be periodically replaced. For the warranty coverage on this component, please check with local iiyama service center.
- If you have to return your unit for service and the original packaging has been discarded, please contact your dealer or iiyama service center for advice or replacement packaging.

CLEANING

WARNING

- If you drop any materials or liquids such as water into the monitor when cleaning, unplug the power cable immediately and contact your dealer or iiyama service center.

CAUTION

- For safety reasons, turn off the power switch and unplug the monitor before you clean it.

NOTE

- To protect the LCD panel, do not scratch or rub the screen with a hard object.
- Never use any of the following strong solvents. These will damage the cabinet and the LCD screen.

Thinner	Spray-type cleaner
Benzine	Wax
Abrasive cleaner	Acid or Alkaline solvent
- Touching the cabinet with any product made from rubber or plastic for a long time may cause degeneration or loss of paint on the cabinet.

CABINET

Stains can be removed with a cloth lightly moistened with a mild detergent solvent. Then wipe the cabinet with a soft dry cloth.

LCD

Periodic cleaning with a soft dry cloth is recommended.

SCREEN

Don't use tissue paper etc. because these will damage the LCD screen.

BEFORE YOU OPERATE THE MONITOR

FEATURES

- ◆ Supports Resolutions up to 1024 × 768 :
ProLite T1531SR / ProLit T1531SAW / ProLite T1532SR
- ◆ Supports Resolutions up to 1280 × 1024 :
ProLite T1731SR / ProLite T1731SAW / ProLite T1931SR / ProLite T1931SAW
- ◆ High Contrast 500:1 (Typical: with Touch panel) / Brightness 200cd/m² (Typical: with Touch panel) : ProLite T1531SR / ProLite T1532SR
- ◆ High Contrast 500:1 (Typical: with Touch panel) / Brightness 230cd/m² (Typical: with Touch panel) : ProLit T1531SAW
- ◆ High Contrast 900:1 (Typical: with Touch panel) / Brightness 200cd/m² (Typical: with Touch panel) : ProLite T1731SR / ProLite T1931SR
- ◆ High Contrast 1000:1 (Typical: with Touch panel) / Brightness 230cd/m² (Typical: with Touch panel) : ProLite T1731SAW
- ◆ High Contrast 900:1 (Typical: with Touch panel) / Brightness 230cd/m² (Typical: with Touch panel) : ProLite T1931SAW
- ◆ Digital Character Smoothing
- ◆ Automatic Set-up
- ◆ Stereo Speakers
2 × 1W Stereo Speakers
- ◆ Plug & Play VESA DDC2B Compliant
Windows[®] 95/98/2000/Me/XP/Vista/7 Compliant
- ◆ Power Management (VESA DPMS Compliant)
- ◆ VESA Mounting Standard (100mm×100mm) Compliant
- ◆ Keyhole for Security Lock

CHECKING THE CONTENTS OF THE PACKAGE

The following accessories are included in your package. Check to see if they are enclosed with the monitor. If anything is missing or damaged, please contact your local iiyama dealer or regional iiyama office.

- Power Cable*¹
- RS-232C Cable
- Screw (M3x6mm)
- Safety Guide
- D-Sub Signal Cable
- USB Cable
- Touch Panel Driver Disk (CD-ROM)*²
- Quick Start Guide
- DVI-D Cable
- Audio Cable

CAUTION *¹ The rating of the Power Cable enclosed in 120V area is 10A/125V. If you are using a power supply higher than this rating, then a power cable with a rating of 10A/250V must be used. However, all guarantees and warranties are void for any problems or damage caused by a power cable not supplied by iiyama.

*² This CD-ROM contains the touch screen driver software.
Install the Touch Panel Driver Disk after connecting the computer to the monitor with RS-232C Cable or USB Cable. For the details, see Readme file in the Touch Panel Driver Disk.

SPECIAL NOTES ON TOUCH PANEL

Permanent damage can occur if Sharp Edged, Pointed or Metal items are used to activate Touch. This could invalidate any remaining warranty.
We recommend to use a plastic stylus (tip R0.8 or over) or finger.

WALL MOUNTING

WARNING When you use with the wall mounting, in consideration of thickness of the mounting stage, tighten the M4 Screw with washer which "L" length is 8mm to fasten the monitor. Using the screw longer than this may cause electric shock or damage because it may contact with the electrical parts inside the monitor.

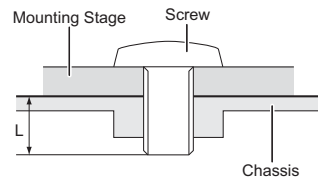



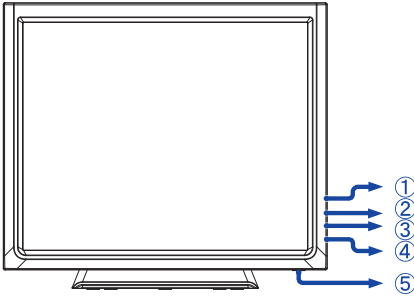

CONTROLS AND CONNECTORS

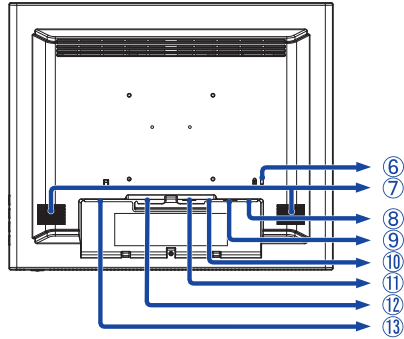

<Front>



<Back>

- ① Menu Button ()
- ② Scroll Up / Brightness Button ()
- ③ Scroll Down / Mute Button ()
- ④ Select / Auto Button ()
- ⑤ Power Switch ()
- ⑥ Keyhole for Security Lock

NOTE You can fasten a security lock and cable to prevent the monitor from being removed without your permission.

- ⑦ Speakers
- ⑧ USB Connector
- ⑨ RS-232C Connector
- ⑩ Audio Connector
- ⑪ D-SUB mini 15pin Connector
- ⑫ DVI-D 24pin Connector
- ⑬ AC Connector

[Fitting and Removal of Cable Cover]

• Removal

- ① Press and hold  of the Cable Cover and remove the Cable Cover.

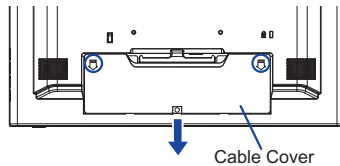

• Fitting

- ① Place the Cable Cover.
- ② Fix the Monitor with the Cable Cover by the screw firmly.

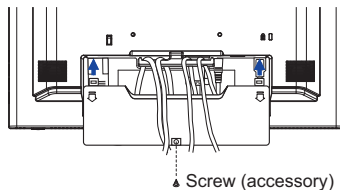

CONNECTING YOUR MONITOR

- ① Ensure that both the computer and the monitor are switched off.
- ② Connect the computer to the monitor with the signal cable.
- ③ Connect the computer to the monitor with the RS-232C Cable or the USB Cable.
- ④ Connect the monitor to the audio equipment with the Audio Cable for computer when using the audio features.
- ⑤ Connect the Power Cable to the monitor first and then to the power supply.
- ⑥ Turn on your monitor and computer.

- NOTE**
- The signal cables used for connecting the computer and monitor may vary with the type of computer used. An incorrect connection may cause serious damage to both the monitor and the computer. The cable supplied with the monitor is for a standard 15 pin D-Sub connector. If a special cable is required please contact your local iiyama dealer or regional iiyama office.
 - For connection to Macintosh computers, contact your local iiyama dealer or regional iiyama office for a suitable adaptor.
 - Make sure you tighten the finger screws at each end of the Signal Cable and the RS-232C Cable.
 - Don't connect the RS-232C cable and the USB cable to the computer at the same time. And cannot use those at the same time.

[Example of Connection]

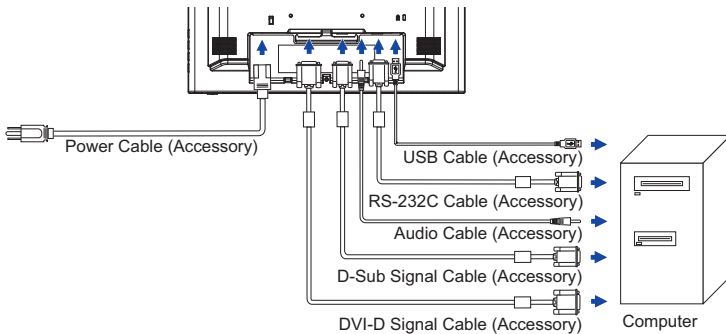

[Collect Cables]

- ① Put the cables through the cable holder and holes.
- ② Collect cables at the back of the stand.

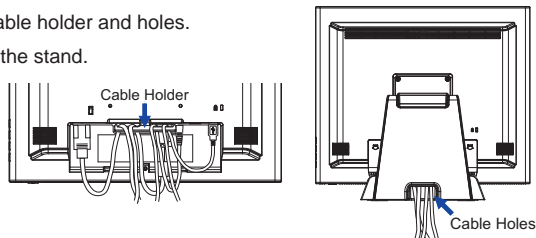

COMPUTER SETTING

■ Signal Timing

Change to the desired signal timing listed on page 28: COMPLIANT TIMING.

■ Windows 95/98/2000/Me/XP/Vista/7 Plug & Play

The iiyama LCD monitor complies with DDC2B of VESA standard. The Plug & Play function runs on Windows 95/98/2000/Me/XP/Vista/7 by connecting the monitor to DDC2B compliant computer with the Signal Cable supplied.

For installation on Windows 95/98/2000/Me/XP: The monitor Information File for iiyama monitors may be necessary for your computer and obtained via the Internet, using the address:

<http://www.iiyama.com>

NOTE

- For additional information on how to download the driver for your touch screen monitor, please access the internet site noted above.
- Monitor Drivers are not required in most cases for Macintosh or Unix operating systems. For further information, please contact your computer dealer first for advice.

■ Procedure for turning ON the Power Switch

Turn ON the monitor first, and then the computer.

■ Touch screen driver software

Touch screen driver software and system may not start when you start your computer while touching the screen.

Touch screen driver software may not run due to the power saving function depending on the BIOS of your computer. In this case, set the power saving function to off.

ADJUSTING THE VIEWING ANGLE

- For optimal viewing it is recommended to look at the full face of the monitor.
- Hold the panel so that the monitor does not topple when you change the monitor's angle.
- You are able to adjust the monitor's angle up to 90 degrees upward, 5 degrees downward.

NOTE

- Do not touch the LCD screen when you change the angle. It may cause damage or break the LCD screen.
- Careful attention is required not to catch your fingers or hands when you change the angle.

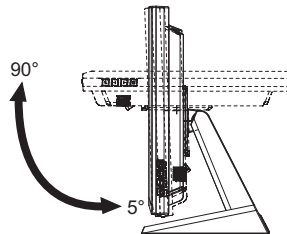
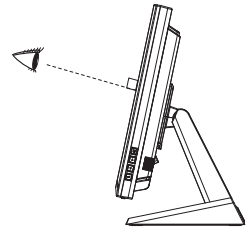



OPERATING THE MONITOR

To create the best picture, your iiyama LCD monitor has been preset at the factory with the COMPLIANT TIMING shown on page 28. You are also able to adjust the picture by following the button operation shown below. For more detailed adjustments, see page 14 for SCREEN ADJUSTMENTS.

- ① **Press the  Button to start the On Screen Display feature. There are additional Menu items which can be switched by using the \triangle/∇ Buttons.**



- ② **Select the Menu item which contains the adjustment icon relating to the adjustment you want to make. Use the \leftarrow/\rightarrow Buttons to highlight the desired adjustment icon.**
- ③ **Use the \triangle/∇ Buttons to make the appropriate adjustment or setting.**
- ④ **Press the  Button to leave the menu, and the settings you just made would be automatically saved.**

For example, to correct for vertical position, select Menu item of . Then, select V-POSITION by using the \leftarrow/\rightarrow Buttons.

Use the \triangle/∇ Buttons to change the vertical position settings. The vertical position of the overall display should be changing accordingly while you are doing this.



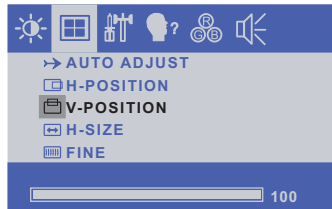





Press the  Button lastly, it ends, any changes are saved in the memory.



NOTE

- When button operations are aborted during adjustment, On-Screen Display disappears when the time set for the OSD TIMEOUT has passed.
- \leftarrow/\rightarrow button can be used to return previous menu item.
- Any changes are automatically saved in the memory when the On Screen Display disappears. Turning off the power should be avoided while using the Menu.
- Adjustments for H/V-POSITION, H-SIZE and FINE are saved for each signal timing. Except for these adjustments, all other adjustments have only one setting which applies to all signal timings.

ADJUSTMENT MENU CONTENTS

 <p>The screenshot shows the OSD menu with a sun icon on the left. The menu items are: CONTRAST, BRIGHTNESS, 1280x1024, FH: 63KHz, and FV: 59.9Hz. The BRIGHTNESS item is highlighted with a blue bar.</p>		
Adjustment Item	Problem / Option	Button to Press
CONTRAST	Too dull Too intense	   
BRIGHTNESS * Direct	Too dark Too bright	   

* Adjust the Brightness when you are using the monitor in a dark room and feel the screen is too bright.

Direct





You can skip the Menu items and display an adjustment scale directly by using the following button operations.























- BRIGHTNESS: Press the  Button when the Menu is not displayed.

Direct

- LOCK MODE:
Press the POWER SWITCH and  Button at the same time when the Menu is not displayed.
The following OSD menu is displayed.

Adjustment Item	Problem / Option	
POWER	LOCK	The POWER SWITCH is Locked.
	UNLOCK	The POWER SWITCH is Unlocked.
OSD	LOCK	The OSD menu is Locked.
	UNLOCK	The OSD menu is Unlocked.

- TOUCH FUNCTION DISABLE:
ON: Pressing and holding of the  Button and the  Button at the same time when the Menu is not displayed, message "TOUCH DISABLE" will appear on the top right corner.
OFF: Pressing and holding of the  Button and the  Button at the same time for about 5 seconds when the Menu is not displayed, till "TOUCH DISABLE" disappears.

Adjustment Item	Problem / Option	Button to Press
AUTO ADJUST *1 Direct	Adjust H/V-POSITION, H-SIZE and FINE automatically.	
H-POSITION	 Too left  Too right	   
V-POSITION	 Too low  Too high	   
H-SIZE *2	 Too narrow  Too wide	   
FINE *2	To correct flickering text or lines	   

*1 For best results, use the Auto Adjust in conjunction with the adjustment pattern. See page 14 for SCREEN ADJUSTMENTS.

*2 See page 14 for SCREEN ADJUSTMENTS.

Direct





You can skip the Menu items and display an adjustment scale directly by using the following button operations.





- AUTO ADJUST: Press the  Button when the Menu is not displayed.

Adjustment Item		Problem / Option		Button to Press	
OSD H-POSITION		OSD is too left			
		OSD is too right			
OSD V-POSITION		OSD is too low			
		OSD is too high			
OSD TIMEOUT		You can set the OSD display duration time between 5 and 60 seconds.			
RESET		Factory-preset data is restored.			
INPUT SELECT		VGA	Select the analog input.		
		DVI	Select the digital input.		

NOTE When only one of the two signal inputs is connected to the signal source, the one connected is automatically selected. Input Select function is not available if there is no signal input from the selected connector or during the power management mode.

Adjustment Item		Problem / Option		Button to Press	
OSD LANGUAGE		ENGLISH	English	ESPAÑOL	Spanish
		FRANÇAIS	French	日本語	Japanese
		DEUTSCH	German	繁體字	Traditional Chinese
		ITALIANO	Italian	简体字	Simplified Chinese

Adjustment Item			Problem / Option		Button to Press	
 COLOR TEMP.	9300	Bluish white				
	6500	Reddish white				
	5500	Greenish white				
	7500	Yellowish white				
	USER	RED	Too weak			
		GREEN	Too strong			
BLUE						

Adjustment Item			Problem / Option		Button to Press	
VOLUME		Too soft				
		Too loud				
MUTE	Direct	ON	Turn off the sound temporarily.			
		OFF	Return the sound volume to the previous level.			

Direct

You can skip the Menu items and display an adjustment scale directly by using the following button operations.

- MUTE : Press the  Button when the Menu is not displayed.

 : MUTE ON

 : MUTE OFF

SCREEN ADJUSTMENTS

Adjust the image by following the procedure below to get the desired picture when selecting Analog input.

- The screen adjustments described in this manual are designed to set image position and minimize flicker or blur for the particular computer in use.
- ProLite T1531 and ProLite T1532 series are designed to provide the best performance at resolution of 1024 × 768, but can not provide the best at resolutions of less than 1024 × 768 because the picture is automatically stretched to fit the full screen. It is recommended to operate at resolution of 1024 × 768 in normal use.
- ProLite T1731 and ProLite T1931 series are designed to provide the best performance at resolution of 1280 × 1024, but can not provide the best at resolutions of less than 1280 × 1024 because the picture is automatically stretched to fit the full screen. It is recommended to operate at resolution of 1280 × 1024 in normal use.
- Displayed text or lines will be blurred or irregular in thickness when the picture is stretched due to the screen enlargement process.
- It is preferable to adjust the image position and frequency with the monitor controls, rather than the computer software or utilities.
- Perform adjustments after a warm-up period of at least thirty minutes.
- Additional adjustments may be required after the Auto Adjust depending on the resolution or signal timing.
- The Auto Adjust may not work correctly when displaying the picture other than the screen adjustment pattern. In this case, manual adjustments are required.

There are two ways to adjust the screen. One way is automatic adjustment for H/V-POSITION, H-SIZE and FINE. The other way is performing each adjustment manually.

Perform the Auto Adjust first when the monitor is connected to a new computer, or resolution is changed. If the screen has a flicker or blur, or the picture does not fit in the display area after performing the Auto Adjust, manual adjustments are required. Both adjustments should be made by using the screen adjustment pattern (Test.bmp) obtained via the Iiyama web site (<http://www.iiyama.com>).

Adjust the image by following the procedure below to get the desired picture.

This manual explains adjustment under Windows 95/98/2000/Me/XP/Vista/7.

- ① **Display the picture at the optimum resolution.**
- ② **Enter the Test.bmp (screen adjustment pattern) to wallpaper.**

NOTE

- Consult the appropriate documentation for doing this.
- Test.bmp is made at resolution of 1280 × 1024. Set the display position to center in the wallpaper setting dialogue box. If you use Microsoft® PLUS! 95/98 cancel the setting of "Stretch desktop wallpaper to fit the screen".

[Adjustment pattern]

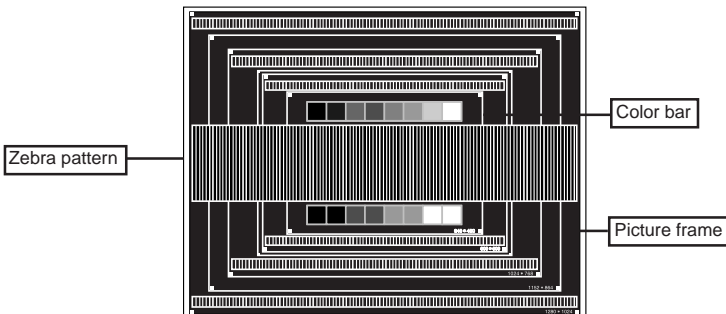

- ③ Press the Auto Button. (AUTO ADJUST)
- ④ Adjust the image manually by following procedure below when the screen has a flicker or blur, or the picture does not fit in the display area after performing the Auto Adjust.
- ⑤ Adjust the V-POSITION so that the top and bottom of the picture frame will fit to the display area.

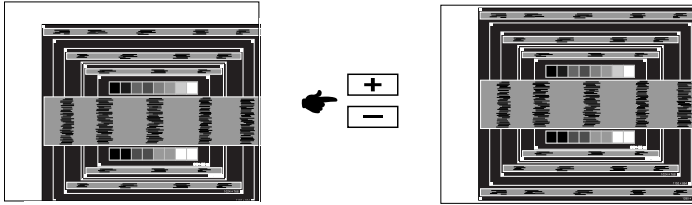

- ⑥ 1) Adjust the H-POSITION so that the left side of the picture frame will move to the left edge of the display area.

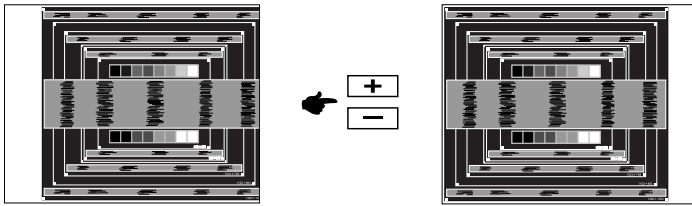

- 2) Stretch the right side of the picture frame to the right edge of the display area by adjusting the H-SIZE.

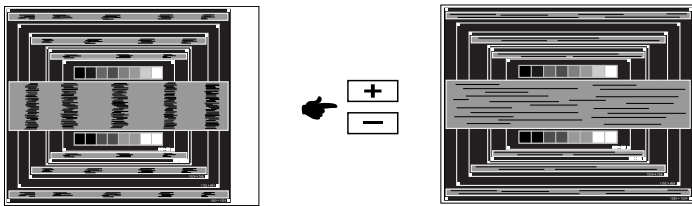

- NOTE**
- When the left side of the picture frame moves apart from the left edge of the display area during the H-SIZE adjustment, adjust steps 1) and 2).
 - Another way to make the H-SIZE adjustment is to correct the vertical wavy lines in the zebra pattern.
 - The picture may flicker during the H-SIZE, H/V-POSITION adjustment.
 - In case the picture frame is bigger or smaller than the data display area after the H-SIZE adjustment, repeat steps from ③.

- ⑦ Adjust the FINE to correct horizontal wavy noise, flicker or blur in the zebra pattern.

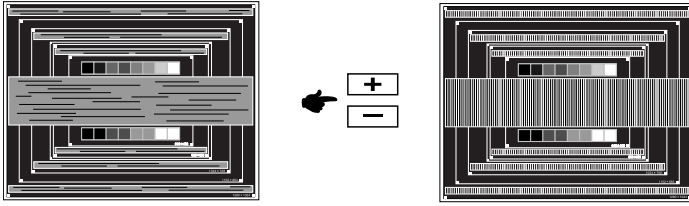
**NOTE**

- In case the strong flicker or blurs remain on a part of the screen, repeat steps ⑥ and ⑦ because the H-SIZE may not be adjusted correctly. If the flicker or blurs still remain, set the refresh rate of computer to low (60Hz) and repeat steps from ③ again.
 - Adjust the H-POSITION after the FINE adjustment if the horizontal position moves during the adjustment.
- ⑧ Adjust the Brightness and Color to get the desired picture after you complete the H-SIZE and FINE adjustments.
Put back your favorite wallpaper.

POWER MANAGEMENT FEATURE

The power management feature of this product complies with power saving requirement of VESA DPMS. When activated, it automatically reduces unnecessary power consumption of the monitor when your computer is not in use.

To use the feature, the monitor needs to be connected to a VESA DPMS compliant computer. There is a power management step the monitor takes as described below. The power management function, including any timer settings is configured by the operating system. Check your operating system manual for information on how this can be configured.

■ Power Management Mode

When the H-sync signal / V-sync signal / H and V sync signals from the computer are off, the monitor enters into Power Management Mode which reduces the power consumption to less than 2W or 3W.* The screen becomes dark. From Power Management Mode, the image reappears in several seconds when either the keyboard or the mouse are touched again.

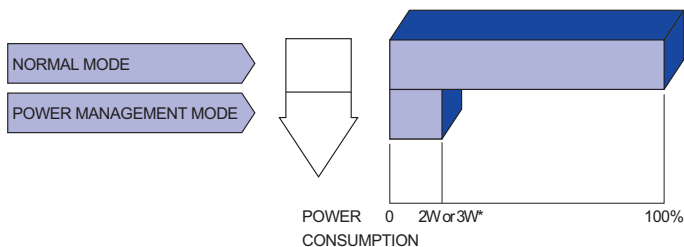

* ProLite T1531SR / ProLite T1731SR / ProLite T1931SR / ProLite T1532SR : 2W
ProLite T1531SAW / ProLite T1731SAW / ProLite T1931SAW : 3W

NOTE

- Even when using the power management mode, the monitor consumes electricity. Turn off the Power Switch whenever the monitor is not in use, during the night and weekends, to avoid unnecessary power consumption.
- It is possible that the video signal from the computer may be on while the H or V sync signal is missing. In this instance, the POWER MANAGEMENT feature may not work properly.

TROUBLE SHOOTING

If the monitor fails to operate correctly, please follow the steps below for a possible solution.

1. Perform the adjustments described in OPERATING THE MONITOR, depending on the problem you have. If the monitor does not get a picture, skip to 2.
2. Consult the following items if you cannot find an appropriate adjustment item in OPERATING THE MONITOR or if the problem persists.
3. If you are experiencing a problem which is not described below or you cannot correct the problem, discontinue using the monitor and contact your dealer or iiyama service center for further assistance.

Problem

Check

- | | |
|---|--|
| ① The picture does not appear. | <input type="checkbox"/> The Power Cable is firmly seated in the socket.
<input type="checkbox"/> The Power Switch is turned ON.
<input type="checkbox"/> The AC socket is live. Please check with another piece of equipment.
<input type="checkbox"/> If the blank screen saver is in active mode, touch the keyboard or the mouse.
<input type="checkbox"/> Increase the Contrast and/or Brightness.
<input type="checkbox"/> The computer is ON.
<input type="checkbox"/> The Signal Cable is properly connected.
<input type="checkbox"/> The signal timing of the computer is within the specification of the monitor.
<input type="checkbox"/> If the monitor is in power management mode, touch the keyboard or the mouse. |
| ② The screen is not synchronized. | <input type="checkbox"/> The Signal Cable is properly connected.
<input type="checkbox"/> The signal timing of the computer is within the specification of the monitor.
<input type="checkbox"/> The video output level of the computer is within the specification of the monitor. |
| ③ The screen position is not in the center. | <input type="checkbox"/> The signal timing of the computer is within the specification of the monitor. |
| ④ The screen is too bright or too dark. | <input type="checkbox"/> The video output level of the computer is within the specification of the monitor. |
| ⑤ The screen is shaking. | <input type="checkbox"/> The power voltage is within the specification of the monitor.
<input type="checkbox"/> The signal timing of the computer is within the specification of the monitor. |
| ⑥ No sound. | <input type="checkbox"/> The audio equipment (computer etc.) is ON.
<input type="checkbox"/> The Audio Cable is properly connected.
<input type="checkbox"/> The Volume is turned up.
<input type="checkbox"/> The Mute is OFF.
<input type="checkbox"/> The audio output level of the audio equipment is within the specification of the monitor. |
| ⑦ The sound is too loud or too quiet. | <input type="checkbox"/> The audio output level of the audio equipment is within the specification of the monitor. |
| ⑧ A strange noise is heard. | <input type="checkbox"/> The Audio Cable is properly connected. |
| ⑨ The touch screen shows no response. | <input type="checkbox"/> The RS-232C Cable or the USB Cable is firmly seated in the socket.
<input type="checkbox"/> Touch screen driver software is installed. |
| ⑩ The touch position does not deviate. | <input type="checkbox"/> The calibration function set up correctly. |

RECYCLING INFORMATION

For better environment protection please don't dispose your monitor.

Please visit our web site: www.iiyama.com/recycle for monitor recycling.

APPENDIX

SPECIFICATIONS : ProLite T1531SR

ENGLISH

Touch Screen	Technology	Resistive-Film
	Surface processing	Anti-glare treatment
	Light transmission	80%
	Communication system	USB serial transfer or RS-232C serial transfer
Size Category		15"
LCD Panel	Driving system	a-Si TFT Active Matrix
	Size	Diagonal: 15" (38cm)
	Pixel pitch	0.297mm H x 0.297mm V
	Brightness	200cd/m ² (Typical: with Touch panel)
	Contrast ratio	500 : 1 (Typical: with Touch panel)
	Viewable angle	Horizontal : 140 degrees, Vertical: 125 degrees (Typical)
	Response time	8ms (Black, White, Black Typical)
Display Colors		Approx.16.7M
Sync Frequency		Horizontal: 31.5-60.2kHz, Vertical: 56-75Hz
Maximum Resolution		1024 x 768, 0.8 MegaPixels
Input Connector		D-Sub mini 15 pin, DVI-D 24 pin
Plug & Play		VESA DDC2B™
Input Sync Signal		Separate sync: TTL, Positive or Negative
Input Video Signal		Analog: 0.7Vp-p (Standard), 75Ω, Positive Digital: DVI (Digital Visual Interface Standard Rev.1.0) compliance
Input Audio Connector		ø 3.5mm mini jack (Stereo)
Input Audio Signal		0.5Vrms maximum
Speakers		1W x 2 (Stereo speakers)
Maximum Screen Size		304.0mm W x 228.0mm H / 12.0" W x 9.0" H
Power Source		100-240VAC, 50/60Hz, 1A
Power Consumption*		20W typical, Power management mode: 2W maximum
Dimensions / Net Weight		351.0 x 306.0 x 201.0mm / 13.8 x 12.0 x 7.9" (WxHxD) 4.8kg / 10.6lbs
Tilt Angle		Upward: 90 degrees Downward: 5 degrees
Environmental Considerations		Operating: Temperature 0 to 40°C / 32 to 104°F Humidity 20 to 80% (No condensation) Storage: Temperature -20 to 60°C / -4 to 140°F Humidity 10 to 90% (No condensation)
Approvals		CE, TÜV-Bauart, Gost-R, VCCI

NOTE * USB peripherals / Audio equipment are not connected.

SPECIFICATIONS : ProLite T1531SAW

Touch Screen	Technology	Surface acoustic wave
	Surface processing	Anti-glare treatment
	Light transmission	92%
	Communication system	USB serial transfer or RS-232C serial transfer
Size Category		15"
LCD Panel	Driving system	a-Si TFT Active Matrix
	Size	Diagonal: 15" (38cm)
	Pixel pitch	0.297mm H x 0.297mm V
	Brightness	230cd/m ² (Typical: with Touch panel)
	Contrast ratio	500 : 1 (Typical: with Touch panel)
	Viewable angle	Horizontal : 140 degrees, Vertical: 125 degrees (Typical)
	Response time	8ms (Black, White, Black Typical)
Display Colors		Approx. 16.7M
Sync Frequency		Horizontal: 31.5-60.2kHz, Vertical: 56-75Hz
Maximum Resolution		1024 x 768, 0.8 MegaPixels
Input Connector		D-Sub mini 15 pin, DVI-D 24 pin
Plug & Play		VESA DDC2B™
Input Sync Signal		Separate sync: TTL, Positive or Negative
Input Video Signal		Analog: 0.7Vp-p (Standard), 75Ω, Positive Digital: DVI (Digital Visual Interface Standard Rev.1.0) compliance
Input Audio Connector		ø 3.5mm mini jack (Stereo)
Input Audio Signal		0.5Vrms maximum
Speakers		1W x 2 (Stereo speakers)
Maximum Screen Size		304.0mm W x 228.0mm H / 12.0" W x 9.0" H
Power Source		100-240VAC, 50/60Hz, 1A
Power Consumption*		20W typical, Power management mode: 3W maximum
Dimensions / Net Weight		351.0 x 306.0 x 201.0mm / 13.8 x 12.0 x 7.9" (WxHxD) 4.8kg / 10.6lbs
Tilt Angle		Upward: 90 degrees Downward: 5 degrees
Environmental Considerations		Operating: Temperature 5 to 35°C / 41 to 95°F Humidity 20 to 80% (No condensation) Storage: Temperature -20 to 60°C / -4 to 140°F Humidity 10 to 90% (No condensation)
Approvals		CE, TÜV-Bauart, Gost-R, VCCI

NOTE * USB peripherals / Audio equipment are not connected.

SPECIFICATIONS : ProLite T1532SR

Touch Screen	Technology	Resistive-Film
	Surface processing	Anti-glare treatment
	Light transmission	80%
	Communication system	USB serial transfer or RS-232C serial transfer
Size Category		15"
LCD Panel	Driving system	a-Si TFT Active Matrix
	Size	Diagonal: 15" (38cm)
	Pixel pitch	0.297mm H x 0.297mm V
	Brightness	200cd/m ² (Typical: with Touch panel)
	Contrast ratio	500 : 1 (Typical: with Touch panel)
	Viewable angle	Horizontal : 140 degrees, Vertical: 125 degrees (Typical)
	Response time	8ms (Black, White, Black Typical)
Display Colors		Approx.16.7M
Sync Frequency		Horizontal: 31.5-60.2kHz, Vertical: 56-75Hz
Maximum Resolution		1024 x 768, 0.8 MegaPixels
Input Connector		D-Sub mini 15 pin, DVI-D 24 pin
Plug & Play		VESA DDC2B™
Input Sync Signal		Separate sync: TTL, Positive or Negative
Input Video Signal		Analog: 0.7Vp-p (Standard), 75Ω, Positive Digital: DVI (Digital Visual Interface Standard Rev.1.0) compliance
Input Audio Connector		ø 3.5mm mini jack (Stereo)
Input Audio Signal		0.5Vrms maximum
Speakers		1W x 2 (Stereo speakers)
Maximum Screen Size		304.0mm W x 228.0mm H / 12.0" W x 9.0" H
Power Source		100-240VAC, 50/60Hz, 1A
Power Consumption*		20W typical, Power management mode: 2W maximum
Dimensions / Net Weight		351.0 x 306.0 x 201.0mm / 13.8 x 12.0 x 7.9" (WxHxD) 4.8kg / 10.6lbs
Tilt Angle		Upward: 90 degrees Downward: 5 degrees
Environmental Considerations		Operating: Temperature 5 to 35°C / 41 to 95°F Humidity 20 to 80% (No condensation) Storage: Temperature -20 to 60°C / -4 to 140°F Humidity 10 to 90% (No condensation)
Approvals		CE, TÜV-Bauart, Gost-R, VCCI

NOTE * USB peripherals / Audio equipment are not connected.

SPECIFICATIONS : ProLite T1731SR

Touch Screen	Technology	Resistive-Film
	Surface processing	Anti-glare treatment
	Light transmission	80%
	Communication system	USB serial transfer or RS-232C serial transfer
Size Category		17"
LCD Panel	Driving system	a-Si TFT Active Matrix
	Size	Diagonal: 17" (43cm)
	Pixel pitch	0.264mm H x 0.264mm V
	Brightness	200cd/m ² (Typical: with Touch panel)
	Contrast ratio	900 : 1 (Typical: with Touch panel)
	Viewable angle	Horizontal : 170 degrees, Vertical: 160 degrees (Typical)
	Response time	5ms (Black, White, Black Typical)
Display Colors		Approx.16.7M
Sync Frequency		Horizontal: 31.5-80.0kHz, Vertical: 56-75Hz
Maximum Resolution		1280 x 1024, 1.3 MegaPixels
Input Connector		D-Sub mini 15 pin, DVI-D 24 pin
Plug & Play		VESA DDC2B™
Input Sync Signal		Separate sync: TTL, Positive or Negative
Input Video Signal		Analog: 0.7Vp-p (Standard), 75Ω, Positive Digital: DVI (Digital Visual Interface Standard Rev.1.0) compliance
Input Audio Connector		ø 3.5mm mini jack (Stereo)
Input Audio Signal		0.5Vrms maximum
Speakers		1W x 2 (Stereo speakers)
Maximum Screen Size		338.0mm W x 270.0mm H / 13.3" W x 10.6" H
Power Source		100-240VAC, 50/60Hz, 1A
Power Consumption*		20W typical, Power management mode: 2W maximum
Dimensions / Net Weight		387.0 x 342.0 x 201.0mm / 15.2 x 13.5 x 7.9" (WxHxD) 5.8kg / 12.8lbs
Tilt Angle		Upward: 90 degrees Downward: 5 degrees
Environmental Considerations		Operating: Temperature 0 to 40°C / 32 to 104°F Humidity 20 to 80% (No condensation) Storage: Temperature -20 to 60°C / -4 to 140°F Humidity 10 to 90% (No condensation)
Approvals		CE, TÜV-Bauart, Gost-R, VCCI

NOTE * USB peripherals / Audio equipment are not connected.

SPECIFICATIONS : ProLite T1731SAW

Touch Screen	Technology	Surface acoustic wave
	Surface processing	Anti-glare treatment
	Light transmission	92%
	Communication system	USB serial transfer or RS-232C serial transfer
Size Category		17"
LCD Panel	Driving system	a-Si TFT Active Matrix
	Size	Diagonal: 17" (43cm)
	Pixel pitch	0.264mm H x 0.264mm V
	Brightness	230cd/m ² (Typical: with Touch panel)
	Contrast ratio	1000 : 1 (Typical: with Touch panel)
	Viewable angle	Horizontal : 170 degrees, Vertical: 160 degrees (Typical)
	Response time	5ms (Black, White, Black Typical)
Display Colors		Approx.16.7M
Sync Frequency		Horizontal: 31.5-80.0kHz, Vertical: 56-75Hz
Maximum Resolution		1280 x 1024, 1.3 MegaPixels
Input Connector		D-Sub mini 15 pin, DVI-D 24 pin
Plug & Play		VESA DDC2B™
Input Sync Signal		Separate sync: TTL, Positive or Negative
Input Video Signal		Analog: 0.7Vp-p (Standard), 75Ω, Positive Digital: DVI (Digital Visual Interface Standard Rev.1.0) compliance
Input Audio Connector		ø 3.5mm mini jack (Stereo)
Input Audio Signal		0.5Vrms maximum
Speakers		1W x 2 (Stereo speakers)
Maximum Screen Size		338.0mm W x 270.0mm H / 13.3" W x 10.6" H
Power Source		100-240VAC, 50/60Hz, 1A
Power Consumption*		20W typical, Power management mode: 3W maximum
Dimensions / Net Weight		387.0 x 342.0 x 201.0mm / 15.2 x 13.5 x 7.9" (WxHxD) 5.8kg / 12.8lbs
Tilt Angle		Upward: 90 degrees Downward: 5 degrees
Environmental Considerations		Operating: Temperature 5 to 35°C / 41 to 95°F Humidity 20 to 80% (No condensation) Storage: Temperature -20 to 60°C / -4 to 140°F Humidity 10 to 90% (No condensation)
Approvals		CE, TÜV-Bauart, Gost-R, VCCI

NOTE * USB peripherals / Audio equipment are not connected.

SPECIFICATIONS : ProLite T1931SR

Touch Screen	Technology	Resistive-Film
	Surface processing	Anti-glare treatment
	Light transmission	80%
	Communication system	USB serial transfer or RS-232C serial transfer
Size Category		19"
LCD Panel	Driving system	a-Si TFT Active Matrix
	Size	Diagonal: 19" (48cm)
	Pixel pitch	0.294mm H x 0.294mm V
	Brightness	200cd/m ² (Typical: with Touch panel)
	Contrast ratio	900 : 1 (Typical: with Touch panel)
	Viewable angle	Horizontal : 170 degrees, Vertical: 160 degrees (Typical)
	Response time	5ms (Black, White, Black Typical)
Display Colors		Approx.16.7M
Sync Frequency		Horizontal: 31.5-80.0kHz, Vertical: 56-75Hz
Maximum Resolution		1280 x 1024, 1.3 MegaPixels
Input Connector		D-Sub mini 15 pin, DVI-D 24 pin
Plug & Play		VESA DDC2B™
Input Sync Signal		Separate sync: TTL, Positive or Negative
Input Video Signal		Analog: 0.7Vp-p (Standard), 75Ω, Positive Digital: DVI (Digital Visual Interface Standard Rev.1.0) compliance
Input Audio Connector		ø 3.5mm mini jack (Stereo)
Input Audio Signal		0.5Vrms maximum
Speakers		1W x 2 (Stereo speakers)
Maximum Screen Size		376.0mm W x 301.0mm H / 14.8" W x 11.9" H
Power Source		100-240VAC, 50/60Hz, 1A
Power Consumption*		20W typical, Power management mode: 2W maximum
Dimensions / Net Weight		432.0 x 390.0 x 218.0mm / 17.0 x 15.4 x 8.6" (WxHxD) 6.6kg / 14.6lbs
Tilt Angle		Upward: 90 degrees Downward: 5 degrees
Environmental Considerations		Operating: Temperature 0 to 40°C / 32 to 104°F Humidity 20 to 80% (No condensation) Storage: Temperature -20 to 60°C / -4 to 140°F Humidity 10 to 90% (No condensation)
Approvals		CE, TÜV-Bauart, Gost-R, VCCI

NOTE * USB peripherals / Audio equipment are not connected.

SPECIFICATIONS : ProLite T1931SAW

Touch Screen	Technology	Surface acoustic wave
	Surface processing	Anti-glare treatment
	Light transmission	92%
	Communication system	USB serial transfer or RS-232C serial transfer
Size Category		19"
LCD Panel	Driving system	a-Si TFT Active Matrix
	Size	Diagonal: 19" (48cm)
	Pixel pitch	0.294mm H x 0.294mm V
	Brightness	230cd/m ² (Typical: with Touch panel)
	Contrast ratio	900 : 1 (Typical: with Touch panel)
	Viewable angle	Horizontal : 170 degrees, Vertical: 160 degrees (Typical)
	Response time	5ms (Black, White, Black Typical)
Display Colors		Approx.16.7M
Sync Frequency		Horizontal: 31.5-80.0kHz, Vertical: 56-75Hz
Maximum Resolution		1280 x 1024, 1.3 MegaPixels
Input Connector		D-Sub mini 15 pin, DVI-D 24 pin
Plug & Play		VESA DDC2B™
Input Sync Signal		Separate sync: TTL, Positive or Negative
Input Video Signal		Analog: 0.7Vp-p (Standard), 75Ω, Positive Digital: DVI (Digital Visual Interface Standard Rev.1.0) compliance
Input Audio Connector		ø 3.5mm mini jack (Stereo)
Input Audio Signal		0.5Vrms maximum
Speakers		1W x 2 (Stereo speakers)
Maximum Screen Size		376.0mm W x 301.0mm H / 14.8" W x 11.9" H
Power Source		100-240VAC, 50/60Hz, 1A
Power Consumption*		20W typical, Power management mode: 3W maximum
Dimensions / Net Weight		432.0 x 390.0 x 218.0mm / 17.0 x 15.4 x 8.6" (WxHxD) 6.6kg / 14.6lbs
Tilt Angle		Upward: 90 degrees Downward: 5 degrees
Environmental Considerations		Operating: Temperature 5 to 35°C / 41 to 95°F Humidity 20 to 80% (No condensation) Storage: Temperature -20 to 60°C / -4 to 140°F Humidity 10 to 90% (No condensation)
Approvals		CE, TÜV-Bauart, Gost-R, VCCI

NOTE * USB peripherals / Audio equipment are not connected.

DIMENSIONS : ProLite T1531SR / ProLite T1531SAW / ProLite T1532SR

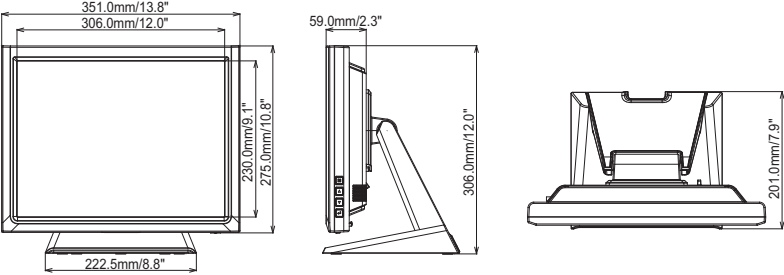

DIMENSIONS : ProLite T1731SR / ProLite T1731SAW

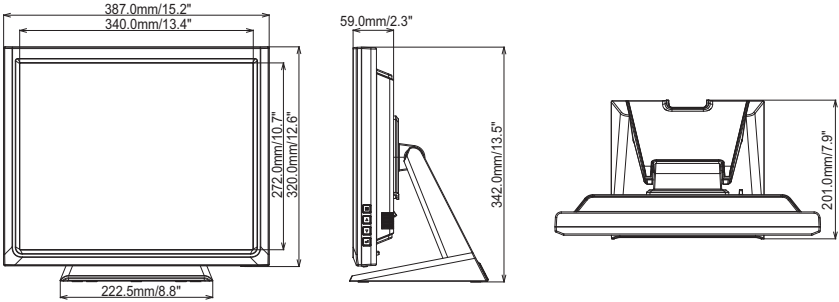

DIMENSIONS : ProLite T1931SR / ProLite T1931SAW

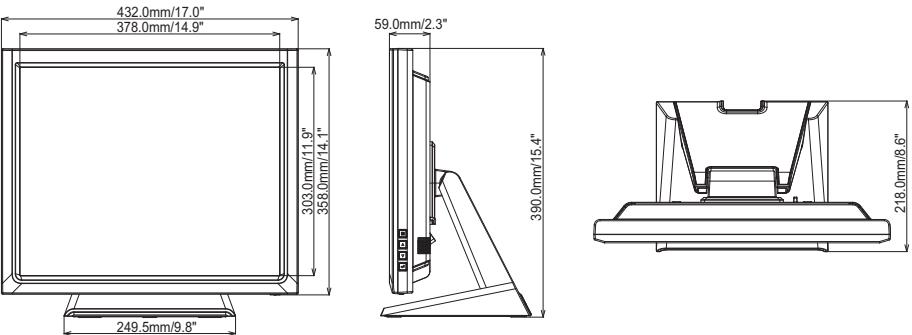

COMPLIANT TIMING

Video Mode		Horizontal Frequency	Vertical Frequency	Dot Clock
VESA	VGA 640 × 480	31.469kHz	59.940Hz	25.175MHz
		37.500kHz	75.000Hz	31.500MHz
		37.861kHz	72.809Hz	31.500MHz
	SVGA 800 × 600	35.156kHz	56.250Hz	36.000MHz
		37.879kHz	60.317Hz	40.000MHz
		46.875kHz	75.000Hz	49.500MHz
		48.077kHz	72.188Hz	50.000MHz
	XGA 1024 × 768	48.363kHz	60.004Hz	65.000MHz
		56.476kHz	70.069Hz	75.000MHz
		60.023kHz	75.029Hz	78.750MHz
	SXGA 1280 × 1024	63.981kHz	60.020Hz	108.000MHz
		79.976kHz	75.025Hz	135.000MHz

*
*

NOTE * Not compliant to ProLite T1531SR / ProLite T1531SAW / ProLite T1532SR.