

User's Guide

TRENDNET[®]



4-Channel HD PoE Kit

TV-NVR104K

Table of Contents

Table of Contents	2
Product Overview	7
Features.....	7
Package Contents.....	7
TV-NVR104 Hardware.....	8
PoE Ports.....	8
Storage Bay	8
Network Port.....	8
Display Ports	8
Audio Ports.....	8
USB Ports	8
TV-NVR104 Management.....	8
Remote Access	8
Camera Setup	8
Live View.....	8
Camera Management	8
Video Recording**	8
Recording Time	8
Scheduled Recording.....	8
Advanced Playback.....	9
Video Export.....	9
Dynamic DNS Support	9
IPv6.....	9
ONVIF	9
TV-IP320PI Hardware	9
Adjustable Bracket.....	9
PoE.....	9
Outdoor Ready.....	9
1.3 Megapixel.....	9
Night Vision.....	9
Smart IR.....	9
D-WDR.....	9
TV-NVR104 Front View.....	10
TV-NVR104 Back Panel	10
TV-IP320PI Hardware Overview.....	11
Hardware installation	12
Wiring for System Setup	12
Connect NVR to your network (optional).....	12
Connect to the cameras	12
Connecting the power supply.....	12
Connect to the monitor or TV	12
Connect the mouse.....	12
NVR Installation	12
Camera Installation.....	13
Viewing angle	13
Weather conditions.....	13
Basic System Setup	14
Soft Keyboard Instruction	14
Keyboard styles	14

Setup Wizard	16	On screen Display Settings.....	33
Start Recording.....	19	Display Settings	33
Instant Playback.....	19	PTZ settings.....	35
System Management (local)	20	Basic pan and tilt.....	35
Using the Short Menu.....	20	Advanced PTZ.....	35
Shortcut Menu	22	Preset positions	36
Instant playback.....	22	Pattern.....	36
Audio.....	22	Patrol.....	37
PTZ control.....	22	Motion Detection.....	38
Digital zoom.....	24	Motion detection settings.....	38
Image settings	25	Privacy Mask.....	41
Live view strategy	25	Video Tamper	42
Close.....	25	Video tamper settings.....	42
Using the Main Menu.....	26	Video Loss.....	44
Login to the Management Pages.....	26	Video loss settings.....	44
Restore Default Password.....	27	System Configuration Menu	46
Logout, start up, or shut down the NVR.....	28	System Settings.....	46
Startup your NVR.....	28	General	46
Shutdown your NVR.....	28	DST settings	47
Rebooting your NVR.....	28	More settings.....	47
Log out from NVR management.....	28	Network.....	48
Camera Settings Menu	29	General	48
Camera Connection Settings	29	DDNS	49
Camera installations.....	29	NTP	49
		Email	50
		UPnP.....	51

More settings.....	51	Network Tools.....	65
Live View.....	52	Network Statistics	66
General.....	52	Hard Drive Maintenance.....	67
View.....	53	S.M.A.R.T Settings	67
Exceptions	54	Bad Sector Detection	68
User Accounts.....	55	Hard Drive Management.....	69
Add.....	55	Format/Initiate the Hard Drive	69
Edit.....	55	Advanced Storage Quota Settings	69
Permission.....	55	Scheduled recording	70
System Maintenance Menu	57	Schedule.....	70
System information	57	Video Settings.....	73
NVR information.....	57	Sub Stream.....	74
Camera information	57	Advanced recording setting.....	75
Recording Information.....	58	Holiday scheduling.....	76
Network Information.....	58	Backup Video Recordings.....	77
Hard Disk Storage Information.....	59	Export	77
Log Information.....	60	Video playback.....	79
Log Search	60	Playback screen.....	79
Log Export	61	Search for video recordings	80
Save and Load NVR System Settings.....	62	Time line.....	80
Firmware Upgrade.....	63	Playback buttons.....	80
Local Upgrade	63	Playback operations	81
Remote Upgrade	63	Playback modes.....	82
Factory Default.....	64	Access your NVR with the Web Browser	85
Network Monitoring.....	65		
Traffic	65		

Default Settings and Factory Reset	85	Port	107
System Requirement.....	85	DDNS	107
Logging-in to the NVR for the First Time (Windows)	85	Video Settings	108
Logging-in to the Camera for the First Time (OS X)	88	Video Format.....	108
Live View.....	94	On Screen Display Settings	109
Playback.....	96	Text Overlay.....	109
Search for video recordings	96	Privacy Mask.....	110
Time Line	96	Video Recording.....	110
Play video.....	97	Holiday Settings.....	111
Slice images from video playback.....	97	Events	113
Download recorded videos.....	98	Motion Detection.....	113
Where can I find saved files?	98	Video Tampering.....	115
Log	99	Exception.....	116
Search for logs.....	99	Email	117
Where can I find saved files?	99	Storage	118
System Information	100	Storage Management.....	118
System Configuration.....	101	Appendix	119
Device Settings.....	101	Turn on network discovery on Windows	119
User Accounts.....	101	Direct video access - RTSP	119
Time Settings.....	102	Install your NVR System on Your Network.....	120
Daylight Savings.....	103	Compatible Camera List.....	121
Live View Settings	104	Regulations.....	122
Maintenance	105	Federal Communication Commission Interference Statement	122
Network Settings	106	FCC Radiation Exposure Statement	122
TCP/IP	106		

Europe – EU Declaration of Conformity	123
Safety	123
EMC.....	123
Directives	123
RoHS.....	124
Power over Ethernet.....	124
Limited Warranty.....	125

Product Overview



Features

TRENDnet's standalone 4-Channel HD PoE NVR Kit, model TV-NVR104K, offers a comprehensive video display, storage, and management solution which features a plug and play PoE camera installation*. The TV-NVR104K comes with a pre-installed 1 TB hard drive and two powerful TV-IP320PI Outdoor 1.3 MP HD PoE IR Network Cameras. The NVR networks and powers up to four PoE cameras*, auto-recognizes TRENDnet cameras, records over 6.5 days of continuous video**, and supports advanced video playback.

Package Contents

TV-NVR104K package includes:

- TV-NVR104 Network Video Recorder
- 2 x TV-IP320PI Network Cameras
- 2 x Network cable (100 ft.)
- Network cable (1.8 m / 6 ft.)
- HDMI cable (1.8 m / 6 ft.)
- Multi-Language Quick Installation Guide
- CD-ROM (User's Guide)
- Camera mounting accessories
- Power adapter (48V DC, 1A)

If any package content is missing or damaged, please contact the retail store, online retailer, or reseller/distributor from which the product was purchased.

**See list of compatible cameras*

***6.5 days of continuous video per camera with four cameras recording 1280 x 960 at 30 fps and set to medium VBR*

TV-NVR104 Hardware

PoE Ports

Plug and play PoE network cameras to the four PoE (IEEE 802.3af) ports with a total PoE budget of 35 Watts

Storage Bay

Pre-installed 1 TB SATA hard drive

Network Port

Ethernet network port

Display Ports

HDMI and VGA display ports

Audio Ports

Audio in and out ports

USB Ports

One USB port for the included mouse and one for configuration backup and firmware upgrade

TV-NVR104 Management

Remote Access

Access the NVR over the internet

Camera Setup

Auto-recognizes compatible TRENDnet cameras*

Live View

Single camera and quad-view modes with variable-time auto-scan function

Camera Management

For each camera, manage on screen display, image settings, PTZ functionality, motion detection, privacy masks, tamper detection, and video loss

Video Recording**

Record up to Full 1080p HD video at 30 fps in H.264 compression (included TV-IP320PI cameras record up to 1280 x 960)

Recording Time

- 6.5 days of recording per camera: 4x cameras with continuous recording at 1280 x 960 at 30 fps
- 8.5 days of recording per camera: 4x cameras with continuous recording at 720p at 30 fps

Scheduled Recording

Create weekly continuous and motion detection recording schedules for each camera with video overwrite when storage is full

Advanced Playback

Advanced archived video playback with a quick reference timeline and calendar

Video Export

Quickly export specific video types over a specified time

Dynamic DNS Support

Support for dyn.com and NO-IP.org

IPv6

IPv6 support

ONVIF

ONVIF compliant

TV-IP320PI Hardware***Adjustable Bracket***

Fully adjustable integrated mounting bracket provides installation flexibility

PoE

Save installation costs with Power over Ethernet (IEEE 802.3af)

Outdoor Ready

Outdoor IP66 weather rated and an operating temperature range of -30 – 60 °C (-22 – 140 °F)

1.3 Megapixel

Record 1280 x 960 pixel HD video at 30 fps in H.264 compression

Night Vision

Night vision up to 30 meters (100 ft.) in complete darkness

Smart IR

Dynamic IR adjustment optimizes night visibility

D-WDR

Digital Wide Dynamic Range improves video quality in high contrast lighting environments

TV-NVR104 Front View

Power: **Solid:** The power is on.
Off: The power is off.

Storage: **Blink:** The system is reading or writing the built-in storage.

Off: The system is not accessing the storage.

Network: The LEDs on network port are always off

TV-NVR104 Back Panel

Power: Power socket of camera (48V DC, 1.04A)

Note: Use only the adapter that came with your camera

Audio In: RCA connector to active microphone (1.0Vp-p, 1kΩ)

Audio Out: RCA connector to speaker (1.0Vp-p, 1kΩ)

VGA: Connect to VGA monitor with resolution higher than 1024 x 768

HDMI: Connect to HDMI monitor or HDTV

USB: Connect to optical mouse and/or external USB flash drive for file import and export.

Network: Connect to your office or home network for remote access and viewing

PoE: Connect 802.3af (15.4W Max.) cameras.

Grounding Point: Connect to grounding wire. This is especially important when you install your camera outdoor.

TV-IP320PI Hardware Overview

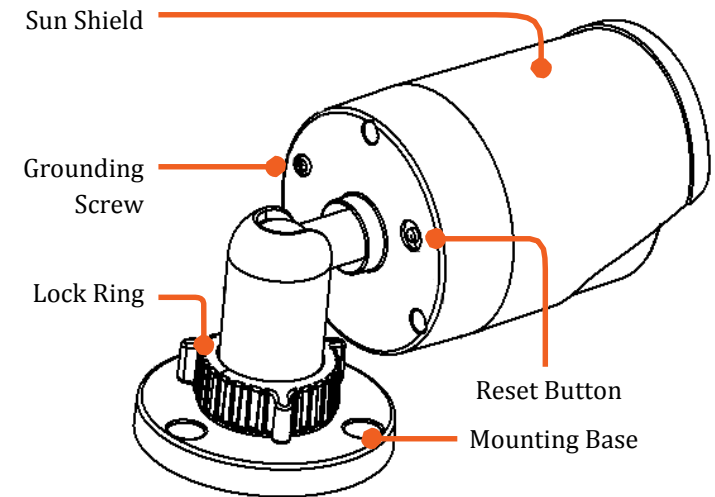

Sun Shield:	Protect camera lens from direct exposure to the Sun.
Reset Button:	Push and hold the reset button then power on the camera. Keep holding the reset button for more than 10 seconds to reset configuration to factory default.
Grounding Screw:	Connects to electric ground.
Lock Ring:	Loosen to adjust the camera position. Tighten to hold the camera position.
Ambient Light Sensor:	Detects the brightness in the environment and enable day/night modes automatically.
IR LEDs:	Infra-red LEDs for night vision.

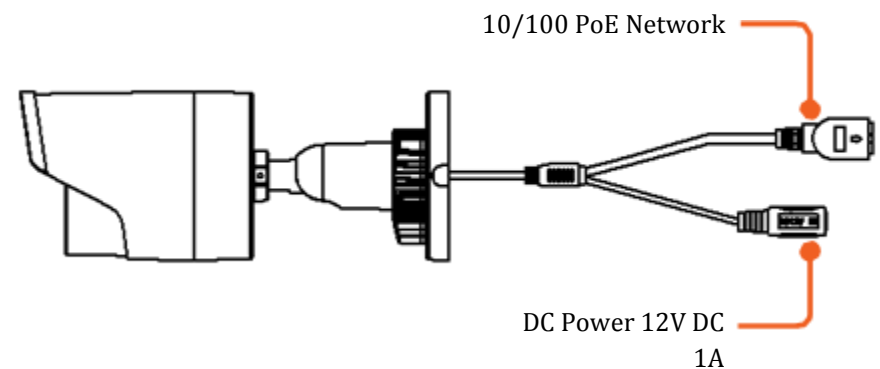

Hardware installation

TV-NVR104K comes with everything you need to set up a basic network surveillance system. Just connect to a monitor or HDTV (not included in this package), you can do the live view and settings on the NVR.

It is recommended to setup the system on your table before physically wiring and mounting the cameras.

Wiring for System Setup

Connect NVR to your network (optional)

If you want to remote access the NVR and want to install the TV-NVR104 on your home network, you can connect the NVR to the network in the first beginning, by connecting one end of your network cable to your home router or network switch, and then connect the other end of the cable to the network port on TV-NVR104.

The TV-NVR104 install cameras automatically after power up. If you decide the let the NVR gets its IP dynamically or setup the IP address to your network, please setup your NVR without camera connected. After the IP set up, power off the NVR and then going through the installation again.

Connect to the cameras

Using the included network cables connect the TV-IP320PI camera's PoE network port to any of the PoE network ports on the NVR. The TV-NVR104 powers up the PoE cameras over the network cable. (So, the optional power connection on the cameras are not using in this installation.)

Connecting the power supply

1. Connect the 48V DC power adapter to the TV-NVR104 power port.
2. Connect the power cables to the power adapters.
3. Plug the power cables into a power source.
4. Connect the grounding point to a ground wire.

Connect to the monitor or TV

Connect a monitor to either the HDMI or VGA port.

Connect the mouse

Connect the included mouse to one of the USB ports.

NVR Installation

Setup a safe and secured place for your NVR. Place it in a locked or not easy accessed place can add more factors in the security. Connecting to a UPS (Uninterruptible Power Supply) is recommended.

Provide a good ventilation and away from clusters and damp environment is also important to the location of your NVR device. Make the NVR installation accessible for annual maintenance to clean up the fan or replace the hard drive is a decent consideration for maintenance.

Camera Installation

There are number of factors involved in a successful camera installation. Follow the suggested installation steps and go through the check lists. This guide will help you make your camera installation smoothly and easily.

Viewing angle

The TV-IP320PI is a bullet camera with a focused viewing angle (70° horizontal) that provides non-distorted and detailed images. Choose the location where has good angle to shoot the image you expect to see. The motion detection area should also be considered when installing the camera.

Weather conditions

The TV-IP320PI is a small bullet camera, which fits most installations indoor and outdoor. The camera can work under a wide range of weather conditions. For severe weather conditions, a camera housing with temperature and moisture control is recommended. Using the camera in milder weather conditions will help extend the camera's product life and preserve the quality of the video image.

- **Moisture:** Avoid damp or moist environments whenever you can. The TV-IP320PI is an IP66 grade water proof camera, and it will work in moist environments. However, rain may affect the picture quality, especially at night, water may reflect the light from the infra-red illumination and degrade picture quality.
- **Temperature:** TV-IP320PI works within a specified temperature range. Areas with severe temperatures should be avoided when installing the camera. It's recommended that you use an enclosure with a heater and blower if you plan on using this camera outside of the specified temperature range.

- **Sunlight:** Avoid direct sun light exposure into the lens. Direct sun light will damage the image sensor. If sunlight is necessary for your viewing purposes, provide protection for the image sensor.
- **Lighting:** Consider installing your camera faces the same direction of the light sources. Shooting images with top-down position outdoor or next to the existing light source are good choices. Avoid the light source if it creates a shade that darkens the viewing area.

Basic System Setup

Soft Keyboard Instruction



To set up your TV-NVR104 with the mouse, you can invoke the soft keyboard on the screen to enter the text.

Keyboard styles

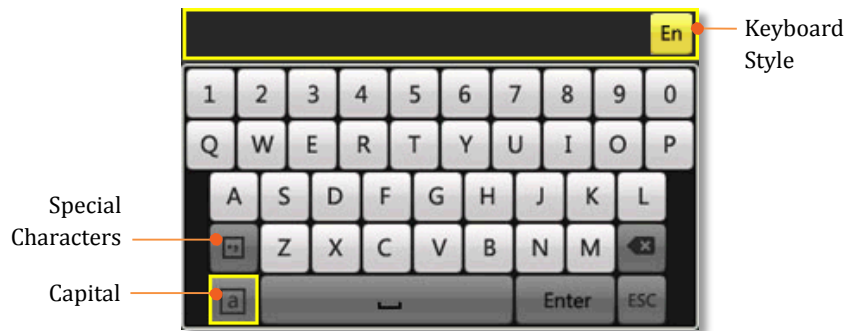
There are three keyboard styles available, English letter, numeric, and special characters. The default keyboard style is English letter keyboard in lower case letter mode. Click the keyboard style button if you want to change it into another style.





List of keyboard styles

	English keyboard (default)
	Numeric keyboard
	Special characters

English keyboard

Click on the letter of your choice to enter the text. Click on the toggle button on lower left corner to switch between upper case and lower case (default)

English keyboard



	Lower case (default)
	Upper case

Numeric keyboard

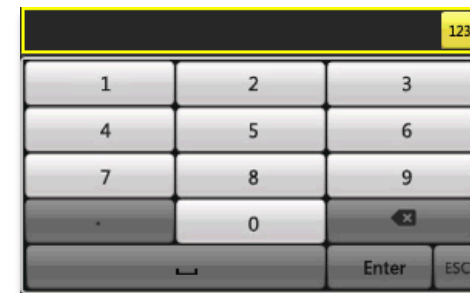

Click on  to change the English keyboard to numeric keyboard.





Special characters

Click on  to the lower left corner to enable the special character menu. Click on  or  on upper right corner to browse through the special characters. Click on the special character of your choice.



Special characters

[En]  
1. 2. 3: 4- 5/



[En]  
1+ 2` 3~ 4! 5@

[En]  
1# 2\$ 3% 4^ 5&

[En]  
1* 2_ 3(4) 5{

[En]  
1} 2[3] 4\ 5|

[En]  
1: 2' 3" 4< 5>

[En]  
1? 2=

Setup Wizard

1. Setup wizard will show up after the TV-NVR104 is powered up. Click **Next** to start the wizard.

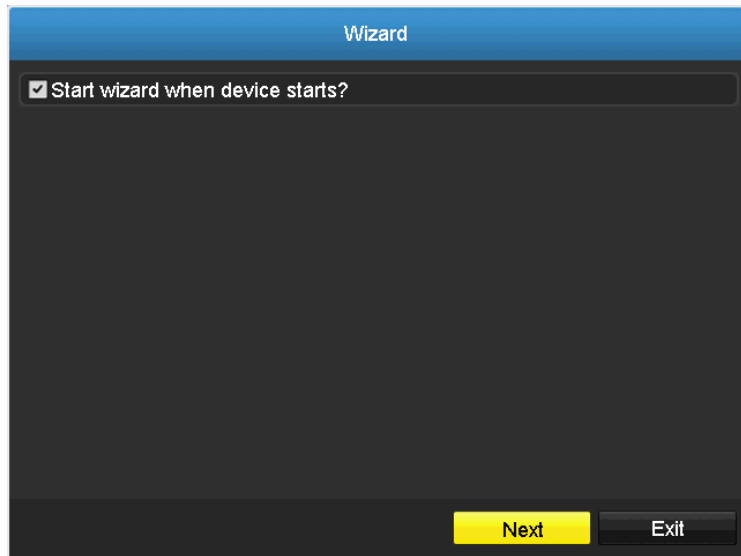

2. Click the text field to the right of **Admin Password**. Enter the default administrator password of **admin**. Click the text field to the right of **New Admin Password** to enter a new administrator password.

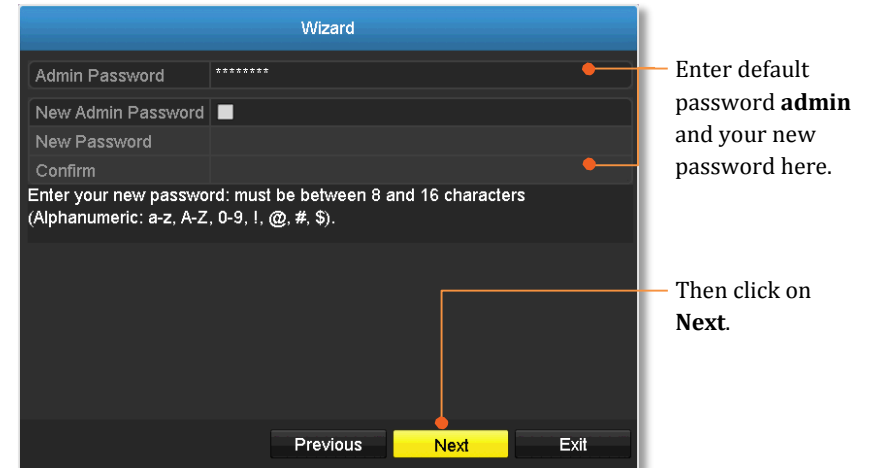

3. Enter the new password again in the **Confirm** text field and then click **Next**.

Note: After the new password is setup, the NVR will install the TV-IP320PI automatically in the background. When the camera installation is done, live video will be displayed.

4. Click the selection list to the right of **Time Zone**.

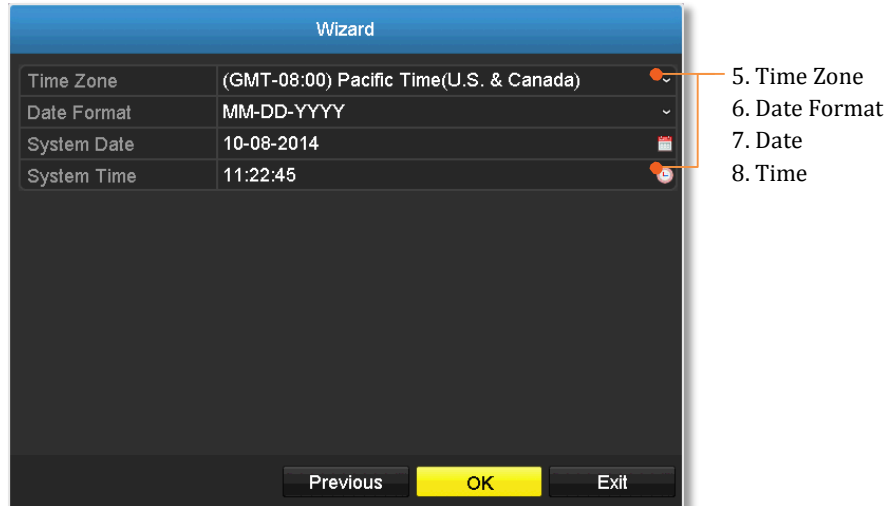

5. Select your time zone.

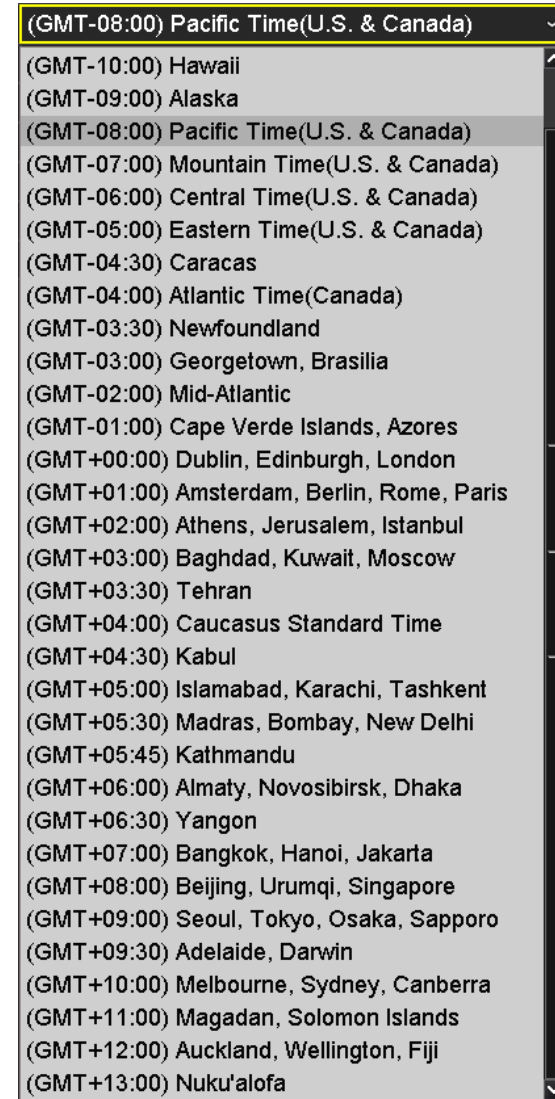

6. Click the selection list to the right of **Date Format** and then select a date format.

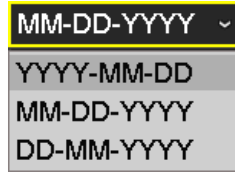

7. Click the selection list to the right of **System Date**.

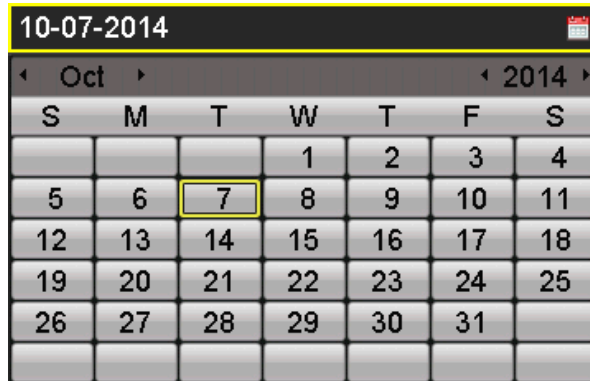

- Select the year by clicking on left or right arrow.
- Select the month by clicking on left or right arrow.
- Select the day by clicking on the date.

8. Click the selection list to the right of **System Time** and then enter the time with 24-hour format.

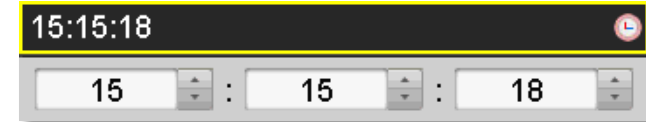

9. Click **OK** to exit the wizard.

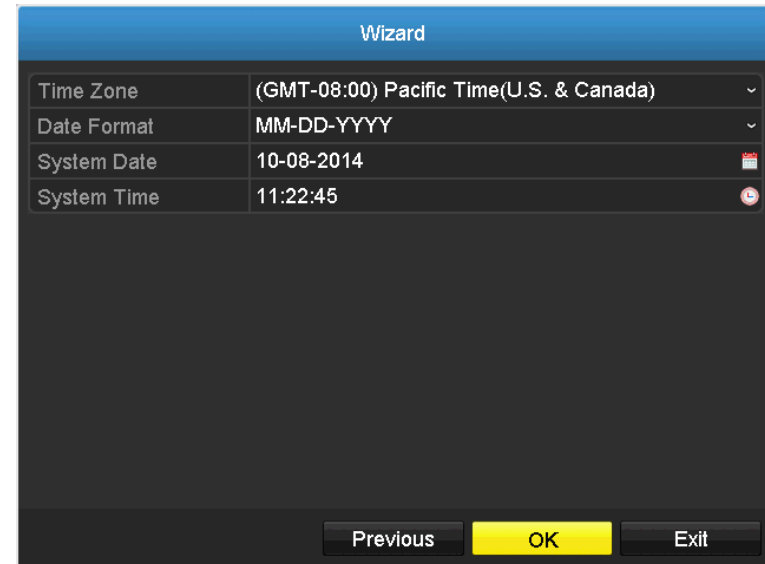

Start Recording

You can start recording immediately just with a few clicks. In Live View, right click on the mouse. A short menu will come up. Choose **Start Recording** and then **Continuous Record**.

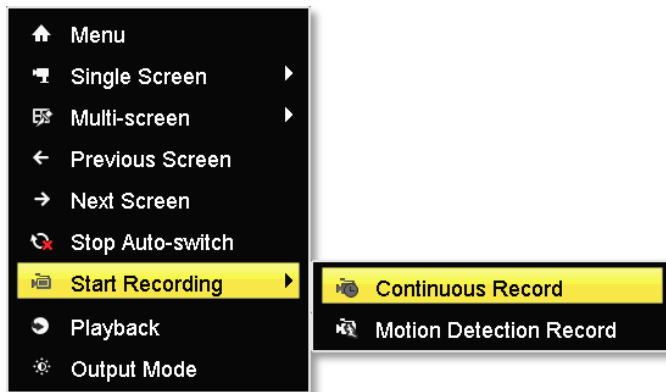

Click **Yes** to start continuous recording. (For more advanced video recording features, please see **Scheduled recording** on page 70 for more details.)

Instant Playback

Move your mouse pointer over the camera display you want to playback the video and select the display by click on it. The instant playback tool bar will show up.



Click on  to playback the last 5 minutes of recording. (For more advanced video playback features, please see the **Video playback** on page 79 for more details.)

System Management (local)

With the basic system setup, your system is now up and running. Now, you can use your mouse pointer and monitor to view, set up, and manage your network video recorder.

Using the Short Menu

Right click your mouse while you are viewing the live video. The short menu will be popped out.

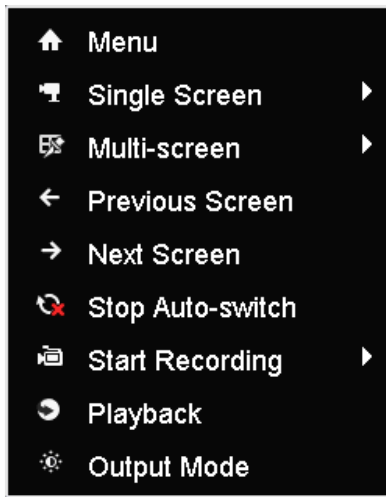

Short Menu

Menu: Click to show the main menu (see page 26 for **Main Menu** instructions)

Single Screen: Display video live view one at a time. Click on **Single Screen** and then choose the camera you want. (The video you choose will be replaced with other video if the **auto-switch** is on, and the auto-switch is on by default.)

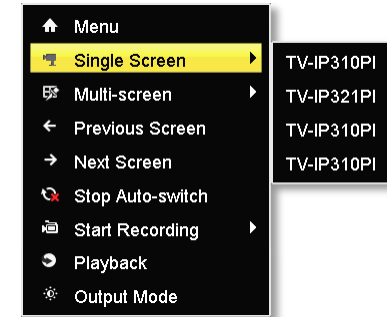

Multi-screen: Display all four video live views at the same time. By default, the video live view is set in the **Multi-screen** mode. If you are now in **Single Screen** mode, click on **Multi-Screen** and then choose **2 x 2** to switch to multi-screen live view mode.

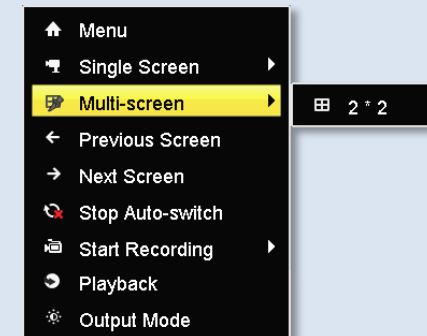

Previous Screen: In **Single Screen** mode, you can manually switch the video to the previous channel.

Next Screen: In **Single Screen** mode, you can manually switch the video to the next channel.

Stop/ Start Auto-switch: Start (default) or stop automatic live view switch. The live view video will be changed by channel sequence.

Start Recording: Start **Continuous** or **Motion Detection** recording.

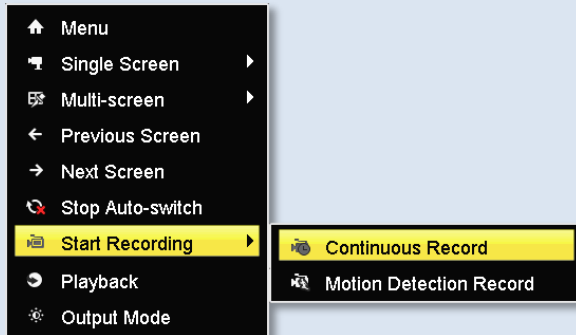

To set up motion detection area, or stop continuous and motion detection recordings, you need to navigate to the detailed settings through the main menu.

Playback: Click **Playback** to go full playback menu. For more information, please reference the please see the **Video playback** on page 79 for more details.

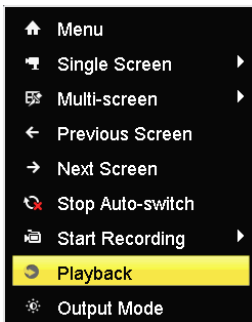

Output Mode: Select a monitor display setting from **Standard**, **Bright**, **Gentle**, and **Vivid** of your choice. Click **OK** to confirm your choice.

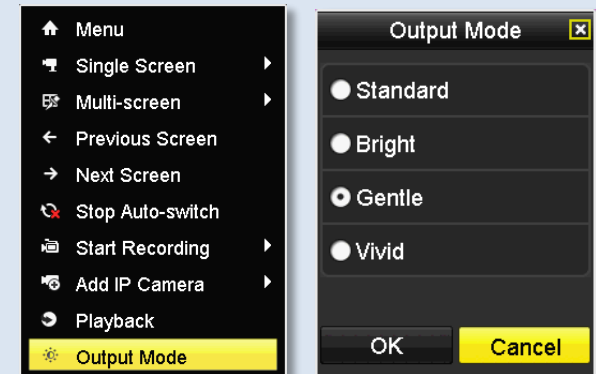

Shortcut Menu

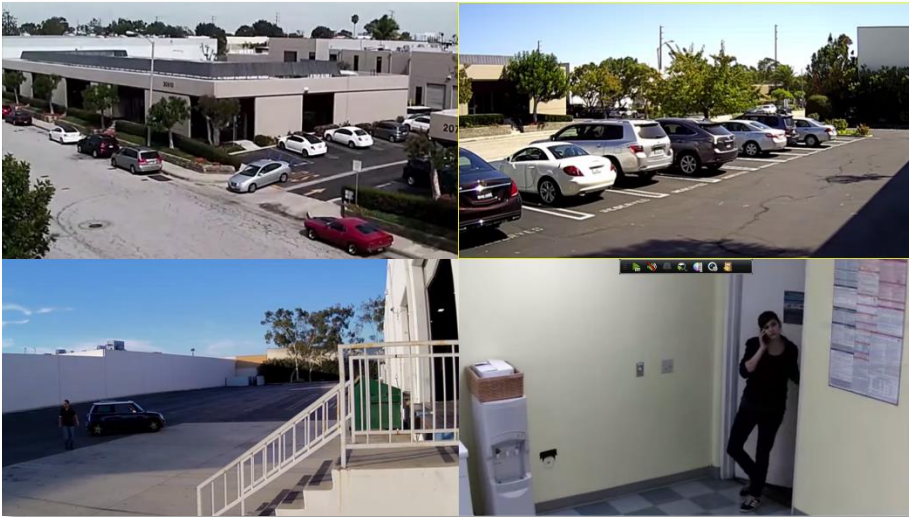

Each video in live view has a short cut menu to perform the frequent adjustments of the video. Move your mouse pointer over the camera display you want to bring up the **Shortcut Menu**. Click on the video. The frame of the video shows active (yellow frame). And then click on the button of the selected jobs.



Instant playback

Click on  to playback the last 5 minutes of recording.

Audio

Click on  to enable the audio on selected channel. Click  to mute the audio.

PTZ control

Click on  to proceed PTZ operations.

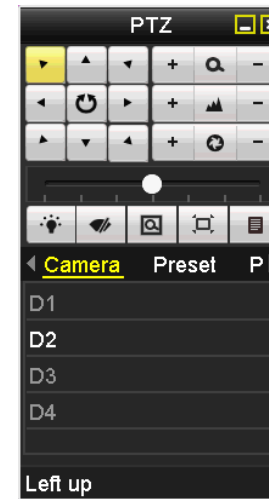

The PTZ menu will show up on the screen.

Basic pan and tilt

Click the buttons you want to pan or tilt the camera. Adjust the distance of each step of moving by sliding the **Speed**. Each step can have farther distance when sliding the **Speed** toward the right, and vice versa.

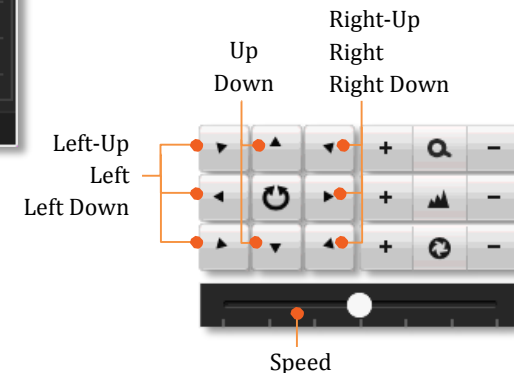

Advanced PTZ

You can further control zoom, focus, and aperture with compliant PTZ camera. Click on + or - to adjust zoom, focus and aperture (iris). Click  button, the camera will turning it around continuously. Click the button again to stop moving.



Special features

(Feature availability depends on camera models)



Turn on or turn off external lighting



Turn on or turn off external wipe on the camera



Zoom operation.

Zoom In: Click and drag area from left to right to zoom in the defined area.

Zoom Out: Drag area from right to the left to zoom out that area.

PTZ menu: Right click on the mouse brings the hidden PTZ menu back.





Center operation. Point and click on the video. The camera will move the camera and make the pointed spot the center of the video.



Menu. Bring up the advanced PTZ menu.

Navigation

Quickly adjust the PTZ camera point and shooting area with presets.

Switch between the lists: Use  and  buttons to switch between different preset lists: Camera, Preset, Patrol, and Pattern.



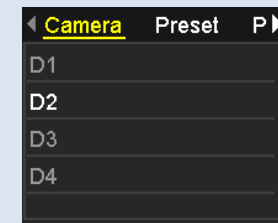

Camera: Select the viewing video channel



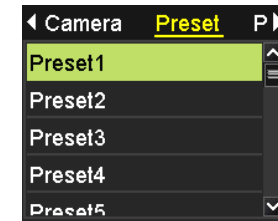

Preset: Select the preset PTZ position. Use the scroll bar to see more presets.



Patrol: Select the preset PTZ patrol. Click  to start patrol and click  to stop patrol.



Pattern: Select the preset PTZ pattern. Click  to start pattern playback and click  to stop patrol.



Digital zoom



Click on  to enable digital zoom. A navigate window will be shown up on the right lower screen corner. Drag and drop or double click to define the area you want to zoom in. The defined area is shown in a red rectangular. Right click to exit the zoom mode.



Image settings

Click on  to adjust the video display settings.

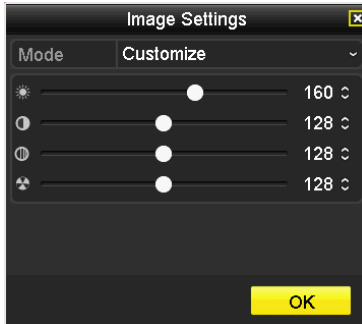

Use the slider or enter a number (0-255) to adjust the image brightness. Default: 128



Use the slider or enter a number (0-255) to adjust the image contrast. Default: 128



Use the slider or enter a number (0-255) to adjust the color saturation. The greater number means the color will be more saturated. Default: 128



Use the slider or enter a number (0-255) to adjust the image HUE setting. Default: 128

Live view strategy

Click on  to manage the live view strategy. The **Real-time** strategy allocate all resources to minimize the delay of video delivery. When the network is congested, the video may be interrupted. **Fluency** strategy makes larger video buffer to save and play video back. It makes the communication more robust, but the live view playback timing is delayed. **Balanced** strategy set up the good enough video buffer to take care of the playback fluency while maintain the network robustness.

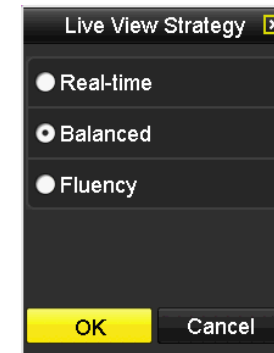

Close

Click on  to close the shortcut menu.

Using the Main Menu

Right click your mouse while you are viewing the live video. The short menu will be popped out. Mouse over the **Menu** and click the button to bring up the **Main Menu**.

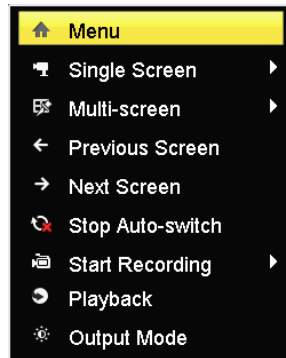

Login to the Management Pages

The NVR will ask you to enter the password every time you want to login to the management page. Enter the password and then click on **OK** to bring up the main menu.

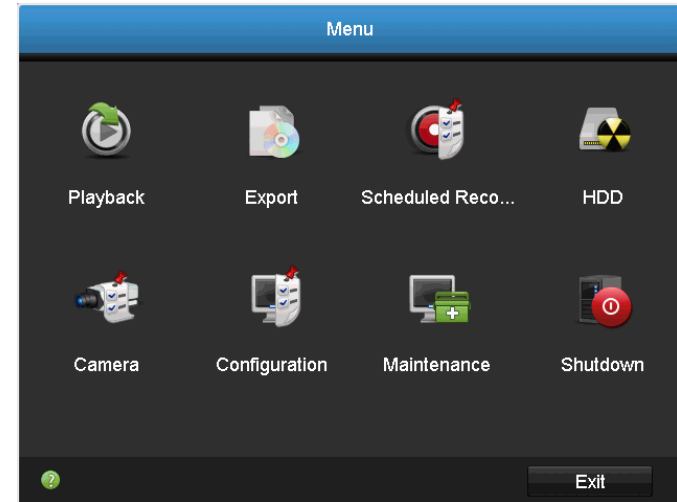
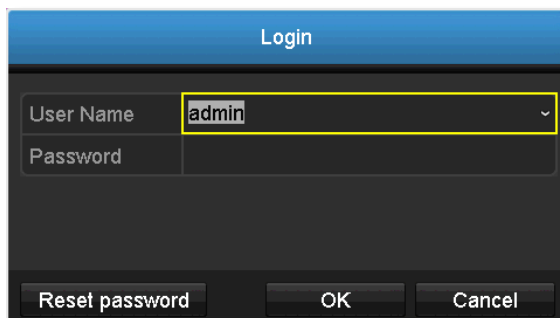

Restore Default Password

For security purposes, if you find yourself in need of restoring the TV-IPNVR104 to factory default settings you will need to contact support.

Click **Reset Password** and provide the Serial Number to the support agent for a temporary access code.

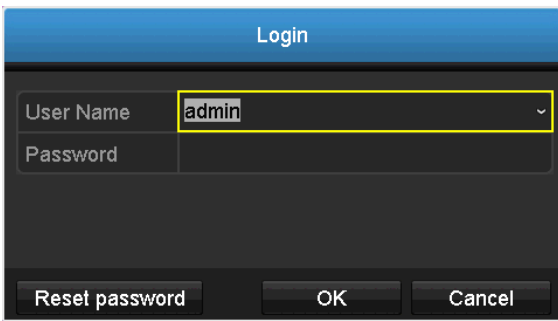

Login	
User Name	admin
Password	
Reset password OK Cancel	

This code is time sensitive; please ensure you reset the password immediately.

USA/Canada phone support:

Toll Free English: (855) 373-4741

- Monday – Friday: 7:00 AM – 5:30 PM, PST

After hours 24/7: (866) 845-3673

Global Support:

Find the support number for your country at:
www.trendnet.com/contact

Online Support:

www.trendnet.com/support/helpdesk

In the call or email, you need to supply the serial information. Click **Reset Password** to get the information. The serial number is a calculated number based on your NVR identity and start up time. Please do not power off your NVR before you complete the password reset process. Otherwise, the secure code you get from the support center may not work to reset the password to factory default.

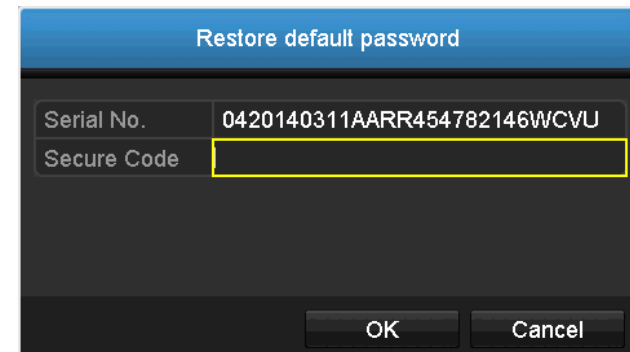

Restore default password	
Serial No.	0420140311AARR454782146WCVU
Secure Code	
OK Cancel	

Logout, start up, or shut down the NVR

The TV-NVR104 is a class A network equipment designed for 24/7 operation. Just plug-in the power source, the TV-NVR104 is up and running. When you want to change the NVR settings, manage the cameras proceed system maintenance or software upgrade, you need to log in, log out, restart, or shut down your NVR gently.

Pulling out the power source may cause unexpected hard drive damage and system malfunction which is not a suggested way to power down your NVR.

Startup your NVR

Make sure the power supply is plugged into an electrical outlet. It is highly recommended that an uninterruptible power supply (UPS) to be used in conjunction with the unit.

Shutdown your NVR

Bring up the main menu. Click on **Shutdown Menu**  icon. The Shutdown sub menu is showing up.

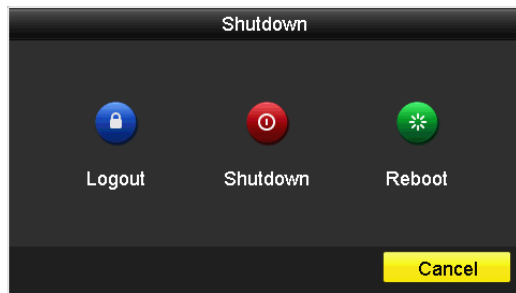

Click **Shutdown**  to gracefully end the recording sessions and prepare the hard drive for shutting down. Then click the **Yes** to confirm that you want to shut down the NVR.



Rebooting your NVR

Click **Reboot**  to reboot your NVR without power down.

Log out from NVR management

When you have done the NVR settings and managements, you'll want to lock your NVR before you leave. Click **Logout**  to exit the NVR management.

Note: You can also set automatic time out. The default setting is 5 minutes without management interaction.

Camera Settings Menu

Setting and manage your cameras by bring up the main menu. Click on

Camera Settings Menu



icon.

Camera Connection Settings



Camera installations

The TV-NVR104K comes with two TV-IP320PI. Other compatible cameras are listed on compatible camera list. There are three major groups of TRENDnet compatible cameras interacts differently with the TV-NVR104, TRENDnet 1, TRENDnet 3, and ONVIF cameras. TRENDnet cameras may fit into one or more camera groups. Please reference the compatible camera list on page 120 for more details.

IP Camera

Camera No. The camera number is also called channel number. All video recordings and camera settings are using this sequential number as the major index number.

Status: This column shows the camera connection status.
: The camera is online. You can click on the icon to show the video and identify which camera you are setting.

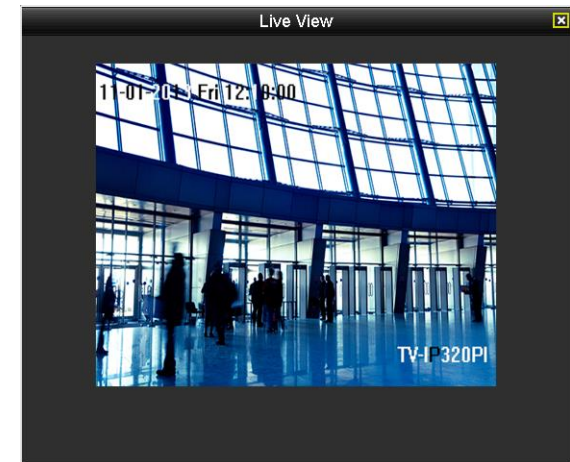

: The camera is not connected to NVR

IP Camera Address: This is the IP address detected by the NVR or set statically to the camera.

Edit: Click this icon to edit the camera connection settings. The default settings is plug-and-play.

Camera Name: This is the camera name. The default name is the camera model name. You can set it up on your camera directly or set it up in NVR for compatible cameras.

Protocol: This is the camera product group. You can choose from TRENDnet 1, TRENDnet 3, ONVIF (generic), or ONVIF installation with other brand name cameras.

Model Number: This is the model number of the camera. The model number will be showed up automatically for compatible cameras.

Management Port: Different camera management protocols has different management port number. Please see the compatible camera list for more detail.

PoE Password Set: If you install plug-and-play TRENDnet 1 with its factory default setting, the TV-NVR104 will set the camera away from the default and load the TV-NVR104 password as camera access password. If your plug-and-play/TRENDnet 1 camera was manually setup and coming back to plug-and-play installation, you can click the button to synchronize the camera password to the same password of TV-NVR104.

When you click this button, all plug-and-play TRENDnet 1 camera passwords are synchronized.

Refresh: Click refresh to refresh the camera list. Only the cameras listed with valid camera index number (1 to 4) are connected to the NVR. Other cameras listed on the table are cameras on the network, but not connected. You can double click on the listed camera, more detailed information will be showed up. The information is valuable for manual camera settings.

Edit IP Camera	
IP Camera No.	D2
Adding Method	Plug-and-Play
IP Camera Address	10.10.10.16
Protocol	TRENDnet3
Management Port	8000
Channel No.	1
User Name	admin
Admin Password	

Back: Click on this button or right click on the mouse to go back to live view.

Net Receive Idle Bandwidth: The TV-NVR104 can process total 25Mbps video streams. This reference number indicates how much more network capacity is available now.

Plug-and-Play installation

This is an effort free installation. Just to make sure all your cameras are set to factory default and connect the plug-and-play cameras to the PoE ports. One for each port. The NVR will detect the camera and install it automatically. TV-IP320PI and TRENDnet 3 cameras are all plug-and-play cameras to TV-NVR104.

If you changed the channel settings before, click the **Edit** icon and then select **Plug-and-Play** on **Adding Method** and then click **OK** to save the settings.

Edit IP Camera	
IP Camera No.	D2
Adding Method	Plug-and-Play
IP Camera Address	10.10.10.16
Protocol	TRENDnet3
Management Port	8000
Channel No.	1
User Name	admin
Admin Password	

OK Cancel

Manual installation

1. Click the **Edit** icon and then select **Manual** on **Adding Method**.

Edit IP Camera	
IP Camera No.	D1
Adding Method	Manual
IP Camera Address	10.10.10.19
Protocol	TRENDnet3
Management Port	8000
Channel No.	1
User Name	admin
Admin Password	

OK Cancel

2. Enter the camera IP address.

IP Camera Address 10.10.10.19 123

1	2	3
4	5	6
7	8	9
.	0	←
↵	Enter	ESC

3. Select the protocol. (See compatible camera list for more details)

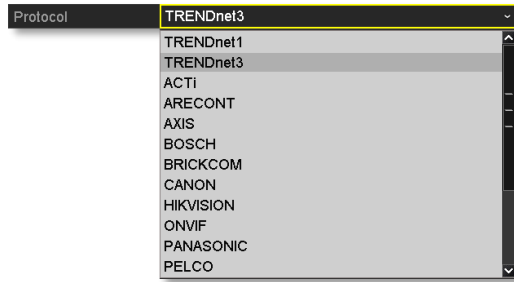

4. Management port. (See compatible camera list for more details)

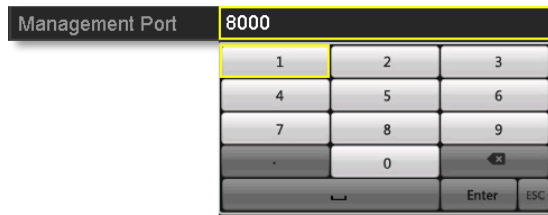

5. Choose the camera video channel number or leave it with default channel 1.

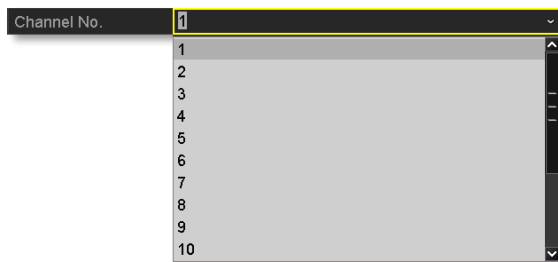

6. Enter camera access user name.

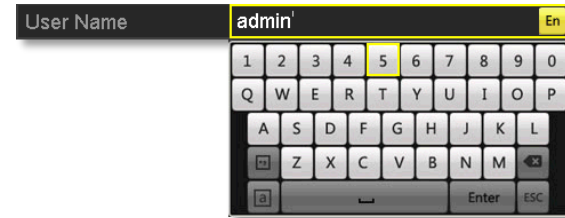

7. Enter camera access password.

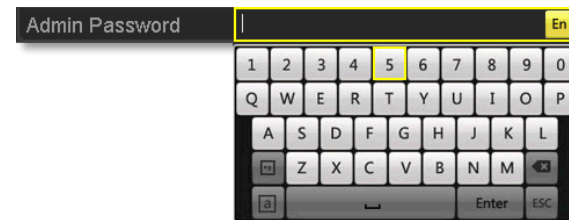

8. Click **OK** to save the settings.

On screen Display Settings

Compatible camera on screen display can be changed directly through camera access or through NVR.

Note: Please reference compatible camera list for more details.

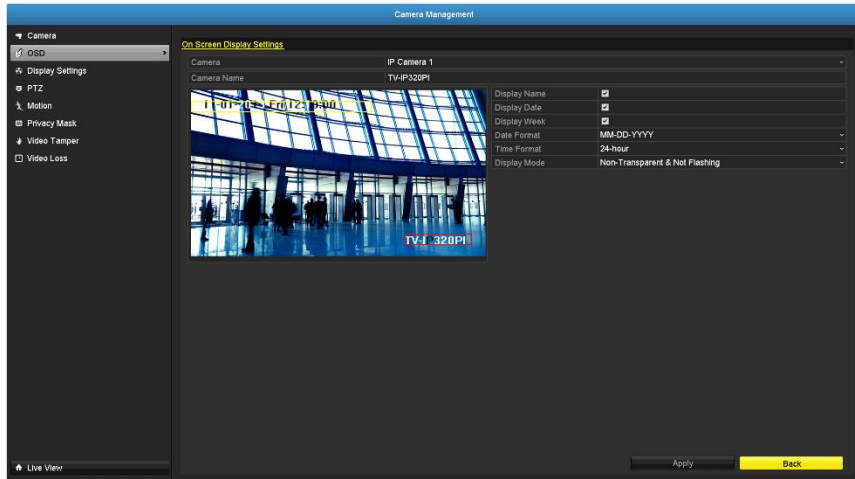

Camera: Click to choose the camera you want to change the settings.

Camera Name: The name of the chosen camera.

Display Name: Check this box to display camera name.

Display Date: Check this box to display system time.

Display Week: Check this box to display time of the week.

Time Format: Select 12 or 24-hour time format.

Date Format: Select the date format

Display Mode: Choose how the text will show on the screen.

*Move the yellow or red box to position the text. Click **Apply** to apply the change.*

Display Settings

Adjust video image quality, lightness, and color settings here.

Note: Please reference compatible camera list for more details.

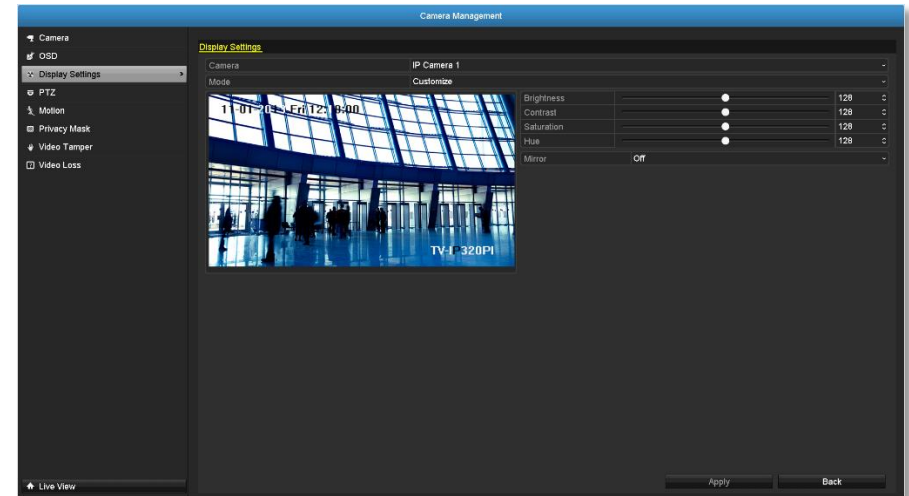

Camera: Click to choose the camera you want to change the settings.

Camera Name: The name of the chosen camera.

Brightness: Use the slider or enter a number (0-255) to adjust the image brightness. Default: 128

Contrast: Use the slider or enter a number (0-255) to adjust the image contrast. Default: 128

Saturation: Use the slider or enter a number (0-255) to adjust the color saturation. The greater number means the color will be more saturated. Default: 128

HUE: Use the slider or enter a number (0-255) to adjust the image HUE setting. Default: 128

Mirror:

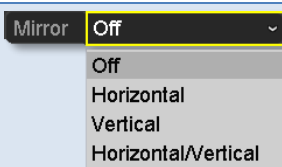

Choose horizontal, vertical or both to adapt to the physical installation.

Click **Apply** to apply the settings.

PTZ settings

Control PTZ camera's video shooting position, patrol route, zoom, focus, and iris.

Note: Please reference compatible camera list for more details.

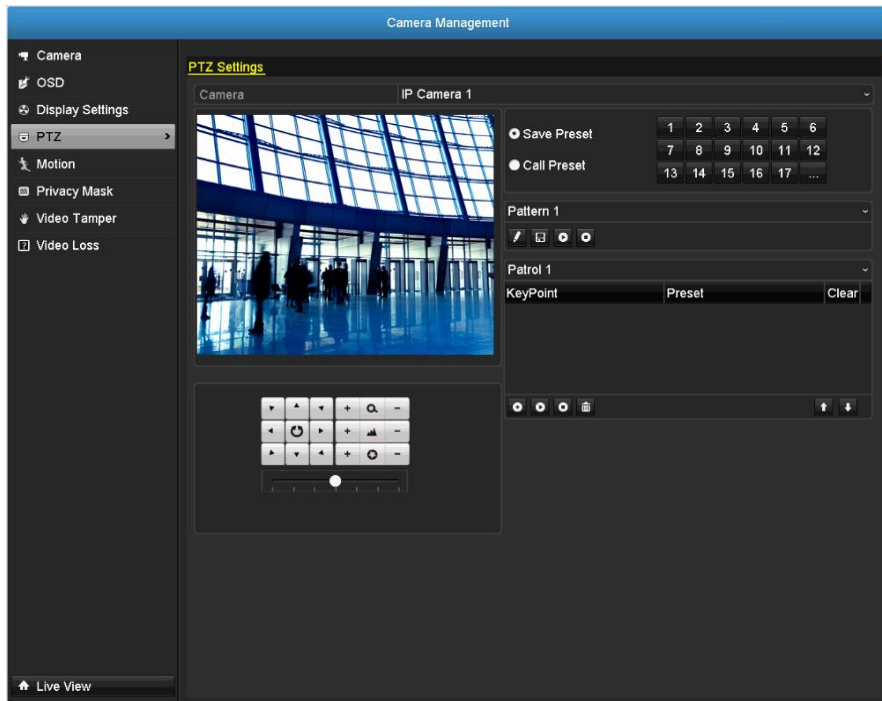

Camera: Click to choose the camera you want to change the settings.

Basic pan and tilt

All compatible PTZ cameras can do the basic pan and tilt to adjust the video shooting position. Click the buttons you want to pan or tilt the camera. Adjust the distance of each step of moving by sliding the **Speed**. Each step can have farther distance when sliding the **Speed** toward the right, and vice versa.

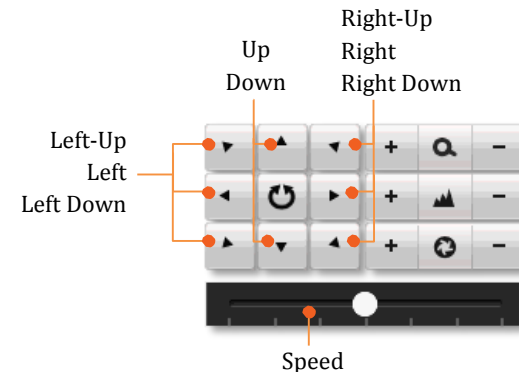

Advanced PTZ

You can further control zoom, focus, and aperture with compliant PTZ camera. Click on + or - to adjust zoom, focus and aperture (iris). Click  button, the camera will turning around continuously. Click the button again to stop policing.





Preset positions

Set and recall the video views and settings for easier navigate and patrol.

To set up a preset:

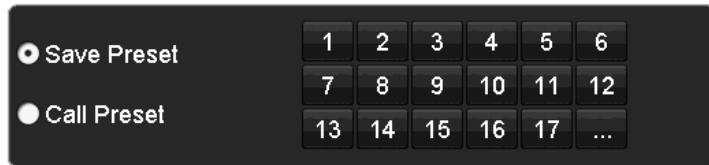
1. Move your camera to the position you want with arrow keys.
2. Adjust the zoom, focus and aperture.
3. Select **Save Preset**.
4. Click the number of preset.



You can setup up to 255 presets depends on camera's capability. To access preset number more than 17, click on . The preset selection screen will pop up. Click up/down arrow to select the preset number you want.





To recall a preset:

1. Select **Call Preset**.
2. Click the number of preset.

Pattern

Setup the patter to perform the navigation automatically.

To edit the pattern:

1. Click  to start recording the pattern.
2. Use preset (Select **Call Preset** and then click on number) or PTZ buttons to move your camera.
3. Click  to stop and save recording.

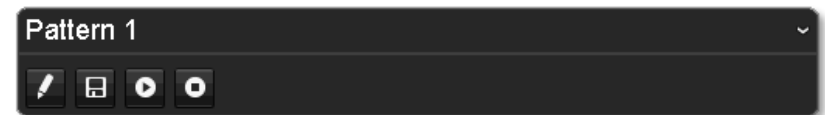

Running the pattern of behaviors:

- Click  to start running the pattern.
- Click  to stop recording.

Patrol

Setup detailed patrol route with key points, speed toward the key point and stop by duration.

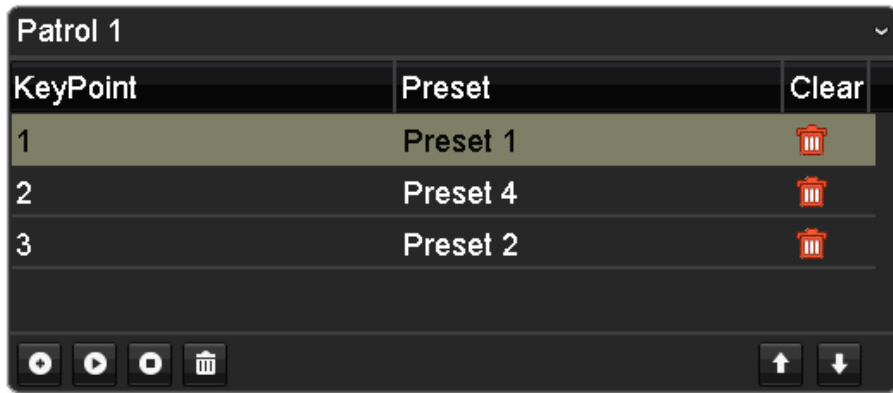
*To edit the patrol*

Note: please setup all preset positions before you edit the patrol route.

1. Click to add a key point. Select the preset number, duration you want to stay on this key point and the speed you want to go this key point and then click OK.

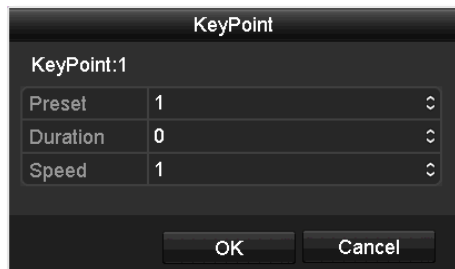

2. To erase a key point, click on the key point. If you want to edit a key point, just erase the key point and then add a new one.
3. Click or to move the order of the patrol key points.
4. Click to clean up all key points.

Start or stop a patrol:

- Click to start patrol.
- Click to stop patrol.

Motion Detection

Set up how the motion detection event will be triggered and what actions will be triggered.

Note: Please reference compatible camera list for more details.

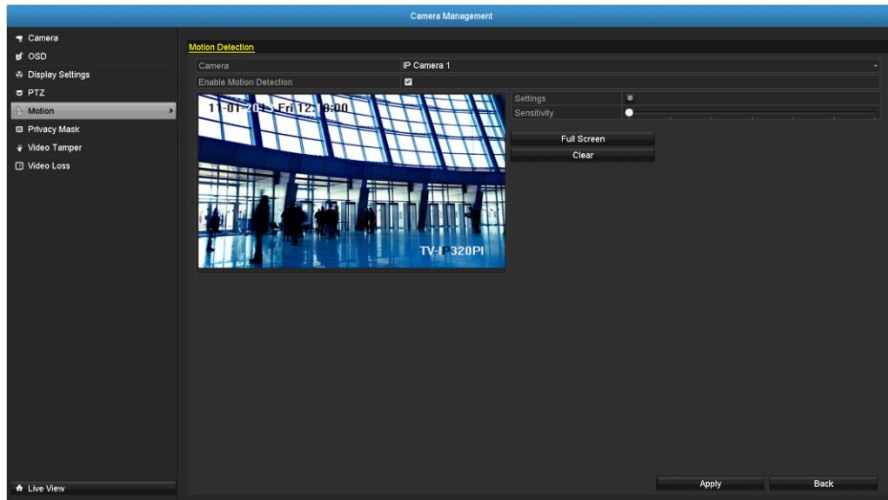

Camera: Click to choose the camera you want to change the settings.

Enable Motion Detection: Check this box to enable motion detection. Click **Apply** to apply the choice.

Settings: Setup the motion detection detail.

Sensitivity: Move the slider to adjust detection sensitivity. Sliding to the right means the motion event is easier to be triggered.

Draw Area: Click and drag on the area you want to set up the motion detection or click **Full Screen** for the whole image area. The red grids represent the motion detection area.

Click **Clear** to clear the motion detection areas.

Motion detection settings

Click **Settings** to bring out the detailed set up menu.

Trigger channel

By default, a motion detection generated by the camera will only trigger the events on that channel. If you want to trigger event on other channels, select the channel number or select **All** for all channels.

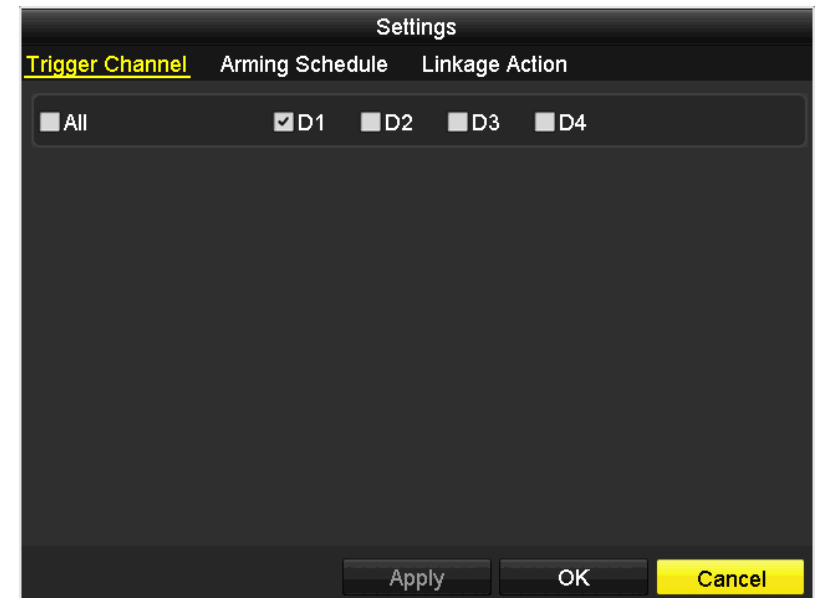

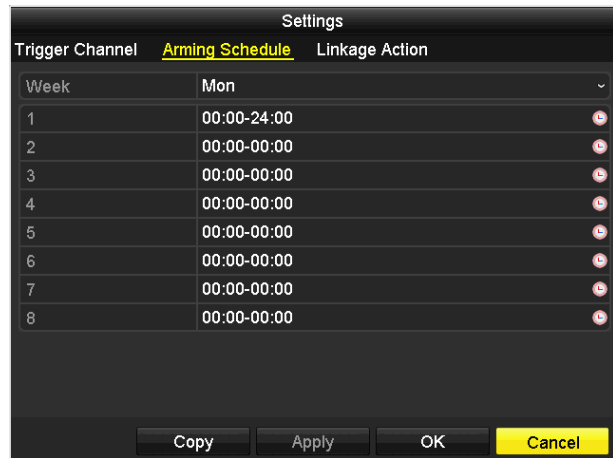
Arming schedule

1. Select day of the week you want to edit on the row of **Week**.

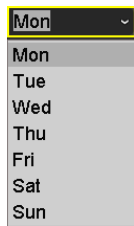

2. Enter the period of time you want to actively detect the motion events.

*Copy to:*

To quickly setup the same schedule over the week, click **Copy**. Click another day of the week (1: Monday, 2: Tuesday, 3: Wednesday, 4: Thursday, 5: Friday, 6: Saturday and 7: Sunday). Click **All** to select the whole week. Click **OK** after you select the day of the week you want to copy to.

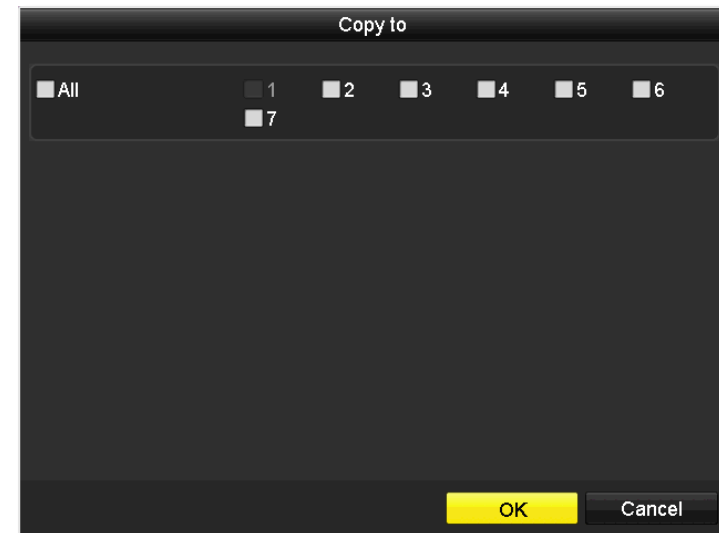

Linkage action

When motion event detected, the corresponding actions will be executed.

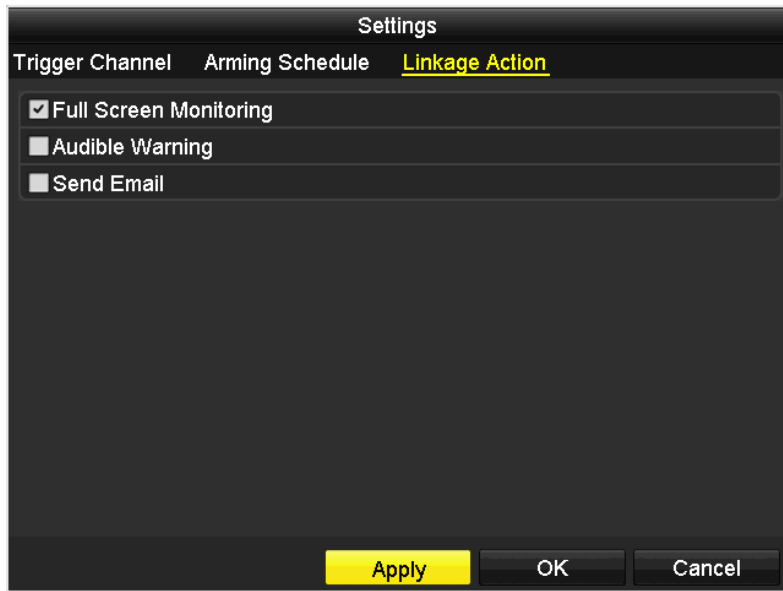

Full Screen Monitoring:	Switch the video on the VGA/HDMI monitor to the camera detected motion event.
Audible Warning:	Activate the audible on board buzzer.
Send Email:	Send email to notify the system manager.

Privacy Mask

Create a masking area to keep your privacy.

Note: Please reference compatible camera list for more details.

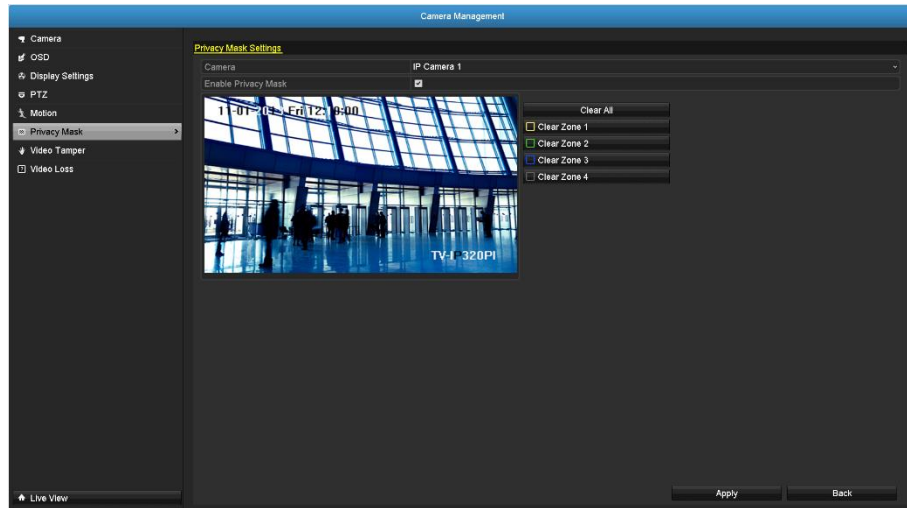

Camera: Click to choose the camera you want to change the settings.

Enable Privacy Mask: Check this box to enable privacy masking.

Draw Area: Click and drag on the area you want to set up the privacy mask.

Clear All: Click this button to clear all the masking area.

Clear Zone 1 to 4: Click this button to clear specific masking area.

*Click **Apply** to apply the changes*

Video Tamper

Detects if a camera has been tampered with and surveillance is compromised. You can set up video tamper notifications to alert the system manager to check the camera.

Note: Please reference compatible camera list for more details.

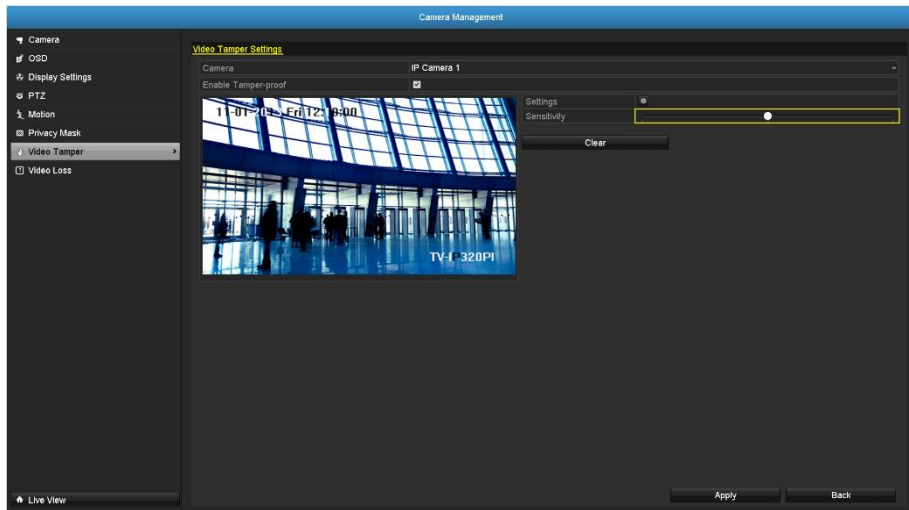

Camera: Click to choose the camera you want to change the settings.

Enable Tamper-proof: Check this box to enable video tamper.

Draw Area: Click and drag on the area you want to set up the video tamper.

Clear: Click this button to clear the video tamper area.

Sensitivity: Move the slider to adjust detection sensitivity. Sliding to the right means the motion event is easier to be triggered.

Click **Apply** to apply the changes

Video tamper settings

Click **Settings** to bring out the detailed set up menu.

Arming Schedule

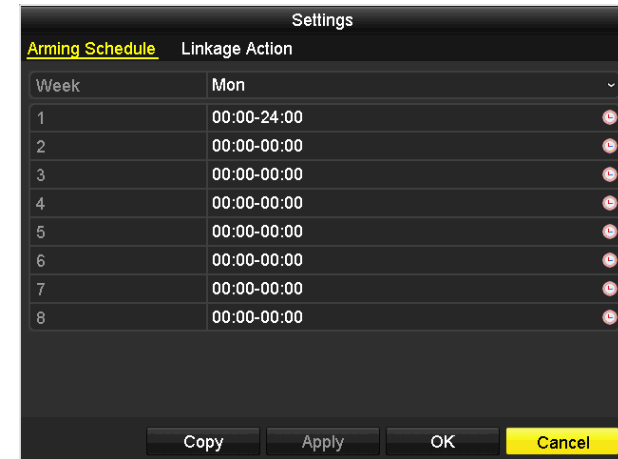

1. Select day of the week you want to edit on the row of **Week**.

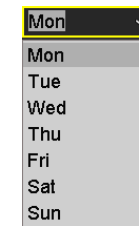

2. Enter the period of time you want to actively detect the motion events.



Copy to:

To quickly setup the same schedule over the week, click **Copy**. Click another day of the week (1: Monday, 2: Tuesday, 3: Wednesday, 4: Thursday, 5: Friday, 6: Saturday and 7: Sunday). Click **All** to select the whole week. Click **OK** after you select the day of the week you want to copy to.

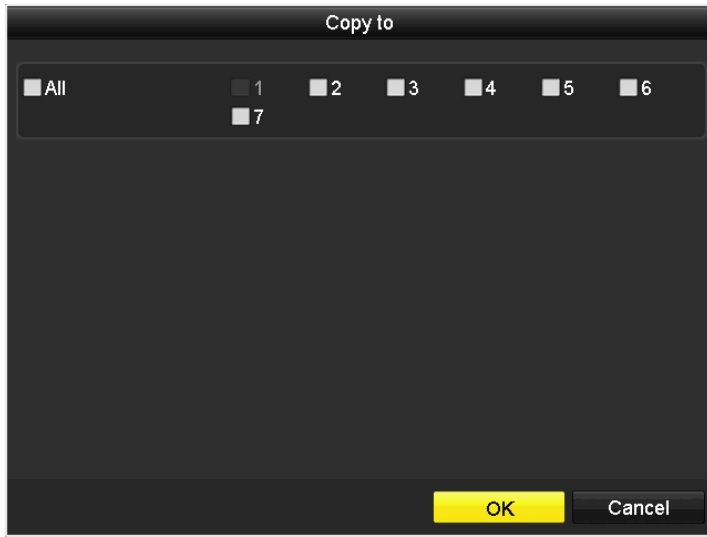
*Linkage action*

When motion event detected, the corresponding actions will be executed.

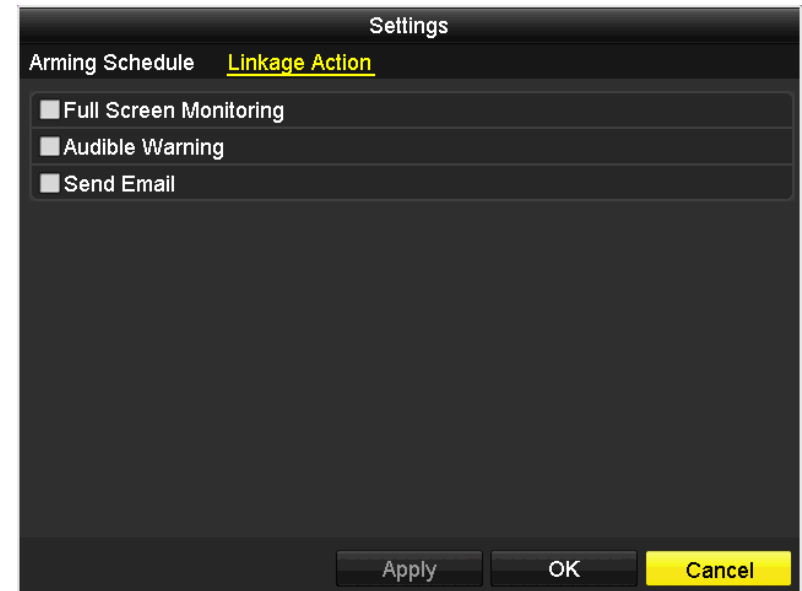

Full Screen Monitoring: Switch the video on the VGA/HDMI monitor to the camera detected motion event.

Audible Warning: Activate the audible on board buzzer.

Send Email: Send email to notify the system manager.

Video Loss

Detects if a camera has lost its video. You can set up video loss notifications to alert the system manager to check the camera.

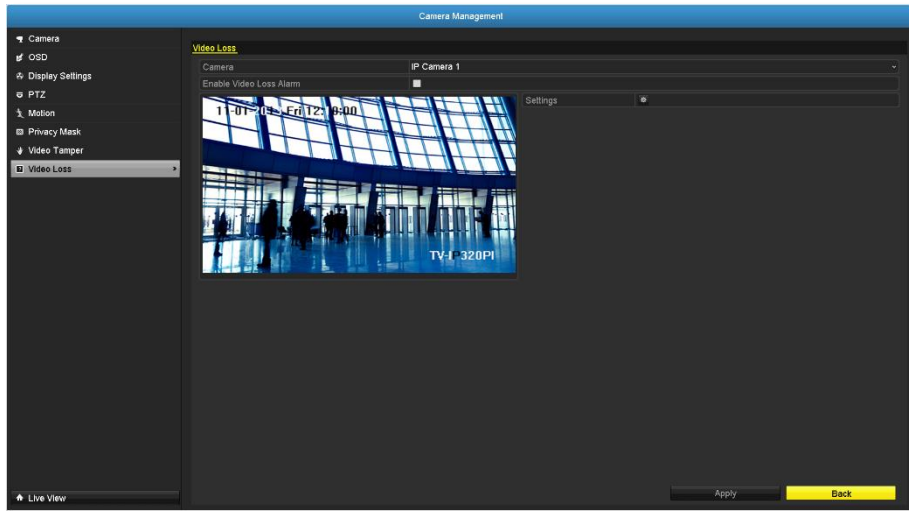

Camera: Click to choose the camera you want to change the settings.

Click **Apply** to apply the changes

Video loss settings

Click **Settings** to bring out the detailed set up menu.

Arming Schedule

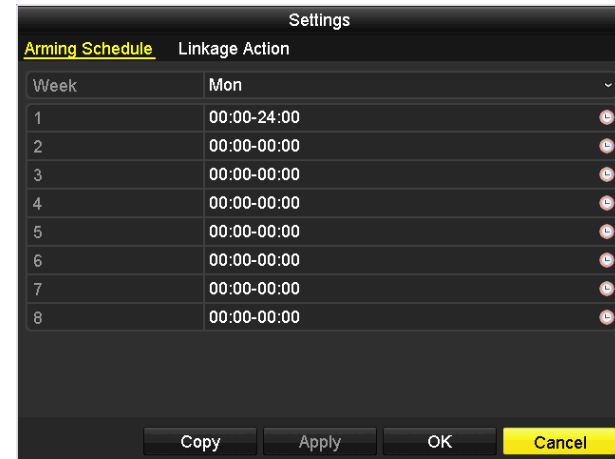

1. Select day of the week you want to edit on the row of **Week**.

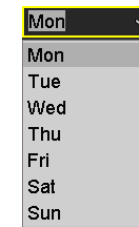

2. Enter the period of time you want to actively detect the motion events.

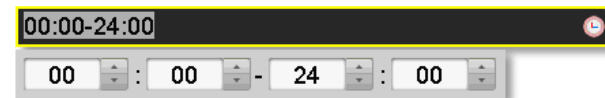

Copy to:

To quickly setup the same schedule over the week, click **Copy**. Click another day of the week (1: Monday, 2: Tuesday, 3: Wednesday, 4: Thursday, 5: Friday, 6: Saturday and 7: Sunday). Click **All** to select the whole week. Click **OK** after you select the day of the week you want to copy to.

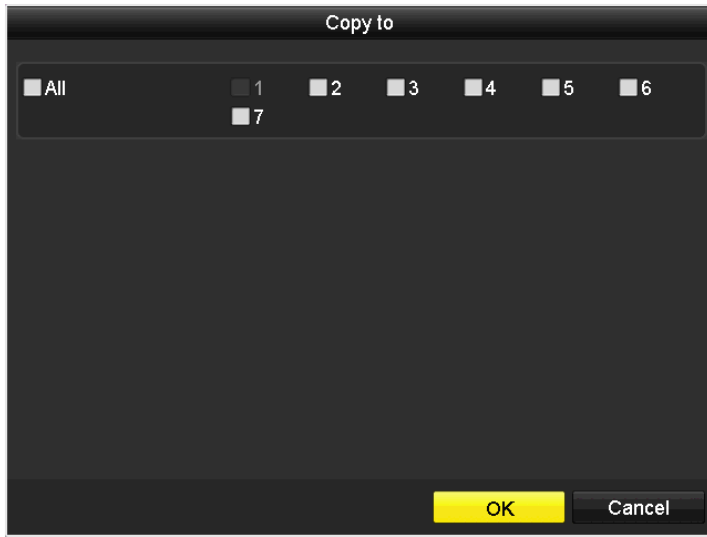
*Linkage action*

When motion event detected, the corresponding actions will be executed.

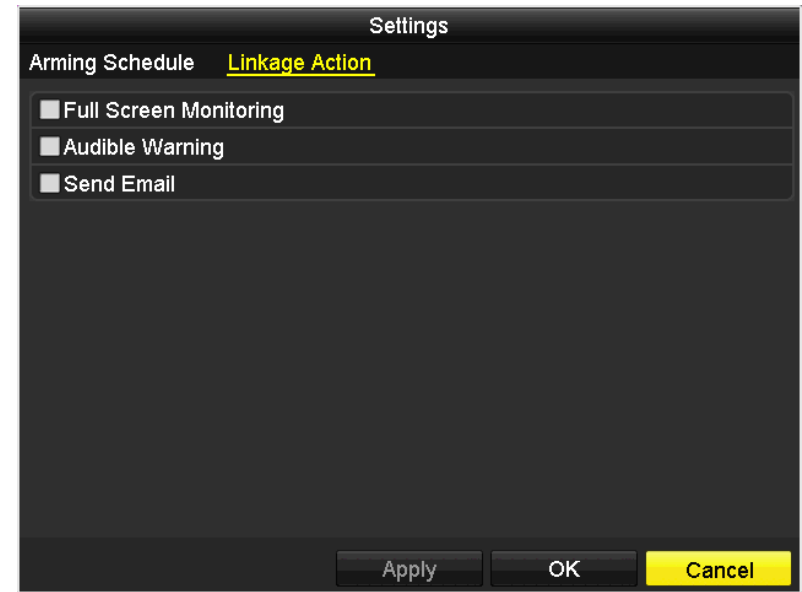

Full Screen Monitoring: Switch the video on the VGA/HDMI monitor to the camera detected motion event.

Audible Warning: Activate the audible on board buzzer.

Send Email: Send email to notify the system manager.

System Configuration Menu

Setting and manage your NVR system by bring up the main menu. Click on

System Configuration Menu  icon.

System Settings

General

Set up the basic time, display resolution, and operation settings here.

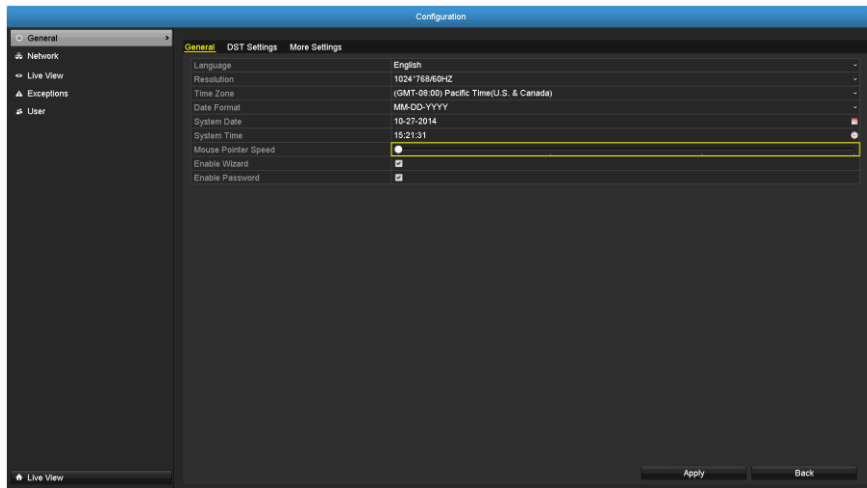

General

- Language:** The TV-NVR104 GUI is setting to English.
- Resolution:** The default monitor resolution is set to the lowest option (1024 by 768) to maximize the monitor compatibility. Choose a better resolution for your monitor to see better quality video.

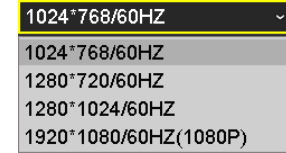

- Time Zone:** Click the selection list to the right of **Time Zone**.
- Date Format:** Click the selection list to the right of **Date Format** and then select a date format.
- System Date:** Click the selection list to the right of **System Date**.
- System Time:** Click the selection list to the right of **System Time** and then enter the time with 24-hour format.
- Mouse Pointer Speed:** Setting the mouse cursor moving speed. Adjusting to the right for faster speed.
- Enable Wizard:** Enable or disable setup wizard every time the system is boot up. Default: Enabled.
- Enable Password:** You need to login for system management. Enable password will ask entering password when login. Uncheck this box will set the management free to anyone physically access the NVR. Default: Enabled.

Click **Apply** to apply the changes.

DST settings

Set up Daylight Saving Time.

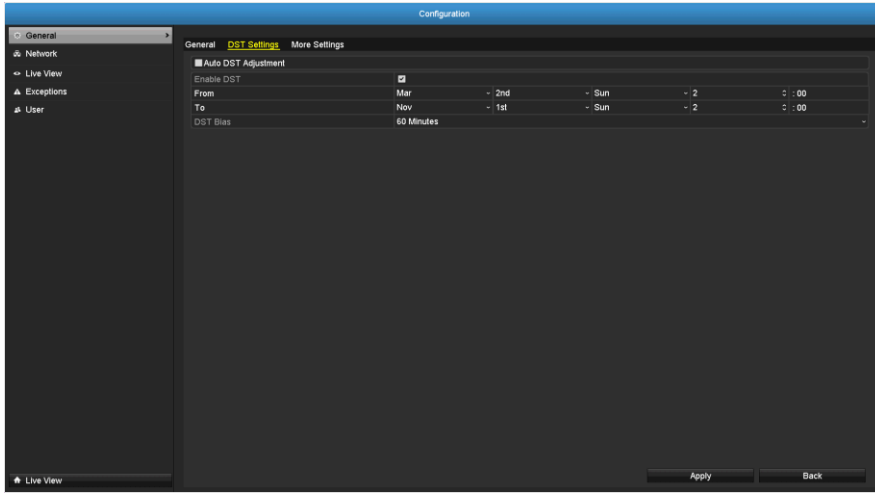

Daylight saving time

Auto DST adjustment: The daylight saving time adjustment is setting to automatic adjustment according to the time zone setting by default. If you want to set the daylight settings manually, uncheck this box to disable the automatic DST adjustment.

Enable DST: Manually enable or disable daylight saving time adjustment.

From / To: Enter the daylight saving time starting and end dates.

Time Zone: Click the selection list to the right of **Time Zone**.

DST Bias: Choose the amount of time shifting for daylight saving adjustment.

Click **Apply** to apply the changes.

More settings

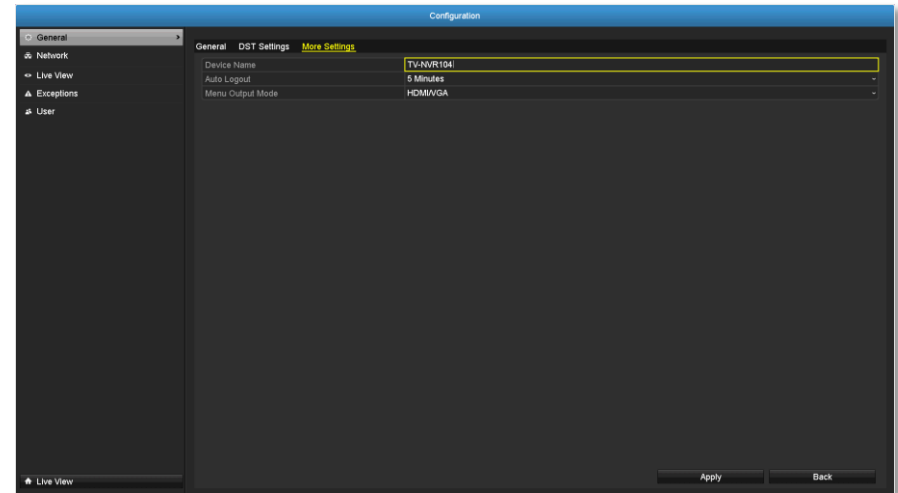

More settings

Device Name: This is the name of the NVR. Default: TV-NVR104

Auto logout: Set up the timeout to logout NVR management after management inactive for a period of time.

Menu Output Mode: The video output is active for both HDMI and VGA interfaces.

Click **Apply** to apply the changes.

Network

Set up NVR network, DDNS, NTP, Email, and UPnP settings.

General

Setup the network interface connecting to the Internet.

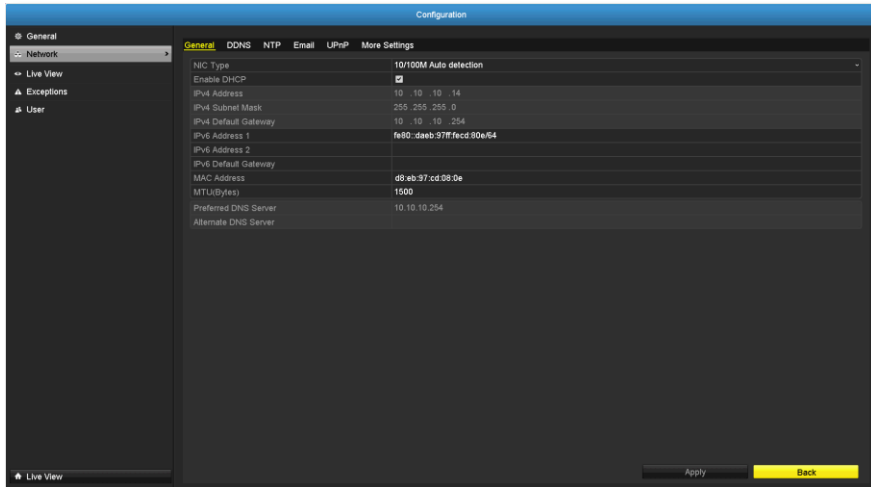

Network General Settings

NIC Type: Choose one of the Ethernet duplex and speed to match your network. Default: 10/100M Auto detection.

Enable DHCP: Check this box if the IP address is assigned by DHCP server.

IPv4 Address: The IPv4 dynamic or static address

IPv4 Subnet Mask: Network range of the subnet

IPv4 Default Gateway: The default route going further from TV-IP320PI IPv4 subnet

IPv6 Address 1: IPv6 self-assigned address including the subnet prefix expression in the end of the string.

IPv6 Address 2: IPv6 static address including the subnet prefix expression in the end of the string.

IPv6 Default Gateway: The default route going further from IPv6 subnet

MAC Address: The MAC address of the NVR network interface.

MTU: Maximum transmission unit. The maximum field size in the Ethernet packet. Default: 1500

Preferred DNS: Enter your first IPv4 or IPv6 DNS server address

Alternate DNS: Enter your second IPv4 or IPv6 DNS server address

Click **Apply** to apply the changes.

DDNS

Dynamic Domain Name Service, DDNS, allows you to find your NVR from the Internet with an easy to remember domain name.

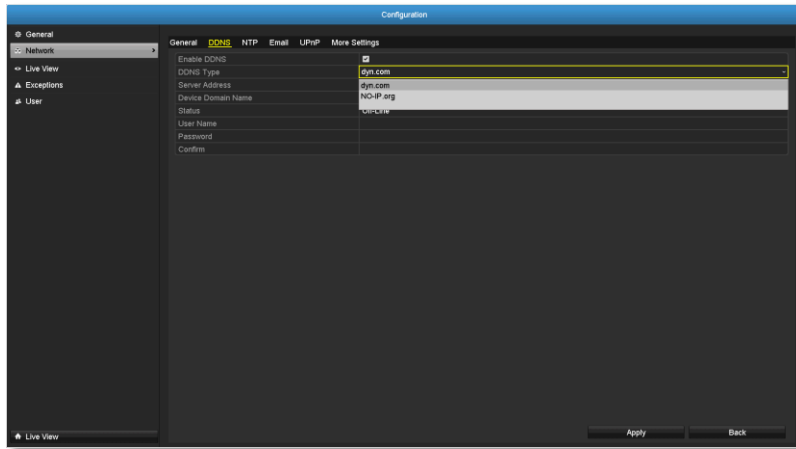
**NTP**

Network Time Protocol Service. The accuracy of the system clock is important for scheduling and accurate logging. You can automatically check the time accuracy with a network time server (NTP server).

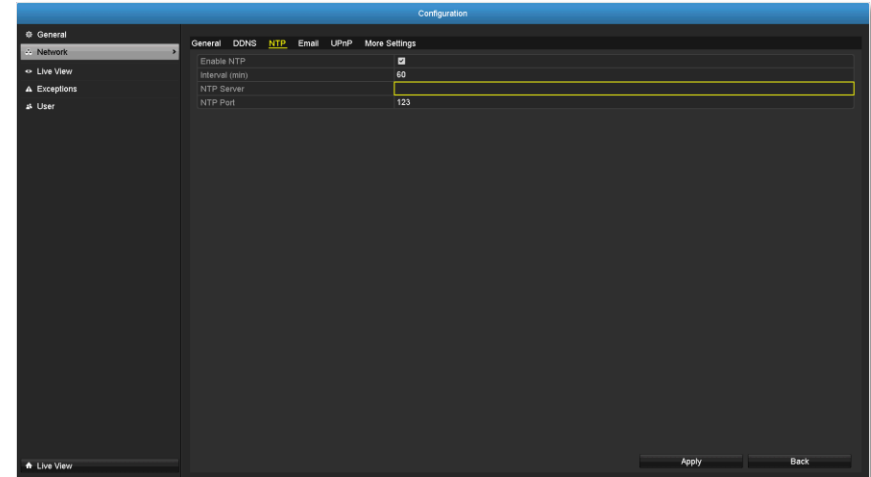
**DDNS**

Enable DDNS: Check this box to enable DDNS Service.

DDNS Type: Select a DDNS service provider: dyn.com or no-ip.com.

Server Address: Enter the DDNS server address.

Device Domain Name: Enter your registered domain/host name on selected DDNS service.

Status: The DDNS connection status.

User Name: Enter the account name.

Password: Enter the password.

Confirm: Enter the password again.

Click **Apply** to apply the changes.

NTP settings

Enable NTP: Check this box to enable NTP Service.

Interval: The time interval that the TV-NVR104 will synchronize the time with NTP server. Default: 60 minutes

NTP Server: Specify a time server (NTP server) to synchronize with. (e.g. pool.ntp.org)

NTP Port: The server port number. Default: 123.

Click **Apply** to apply the changes.

Email

Set up email accounts for notifications.

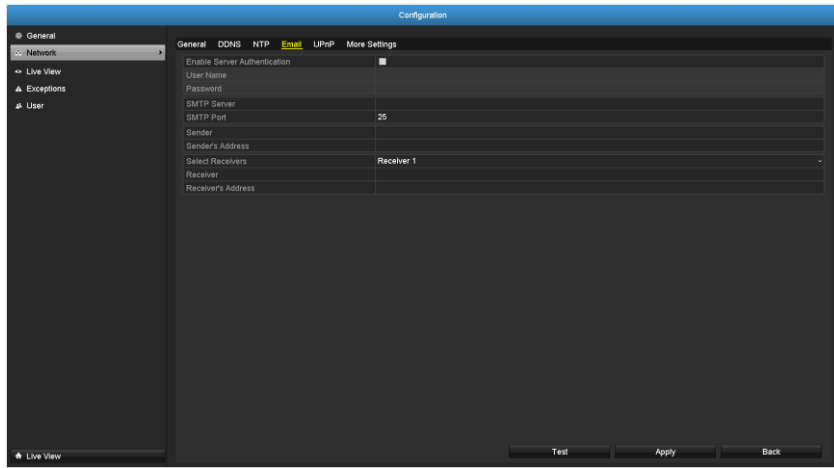

Email

Enable Server Authentication: Check this box if your server requires a password in order to send email. Most email servers require authentication when sending an email.

User name: Enter the user name of outgoing email account

Password: Enter the password

SMTP Server: Simple Mail Transportation Protocol Server address, the outgoing email server address. It may have the same address as your incoming email server, maybe not. Please ask your email service provider for detail.

SMTP Port: Service port number for outgoing email.*

Sender: Enter the name to be appeared as the email sender.

Sender's Address: Enter sender's email address.

Select Receiver: Select the pull down menu to select the receiver you want to set up the detail. You can send to 3

accounts at the same time, but just set up separately.

Receiver: The receiver's name.

Receiver's Address: The receiver's email address.

**Note: Many ISPs do not allow service port 25 going through their network. Please consult your email service provider and ISP for detail.*

Click **Apply** to apply the changes.

Click **Test** to test if all the information are entered correctly.

UPnP

Universal Plug-and-Play is a device discovery protocol set. It allows your camera to easily be found, for example, on a Windows operation system.

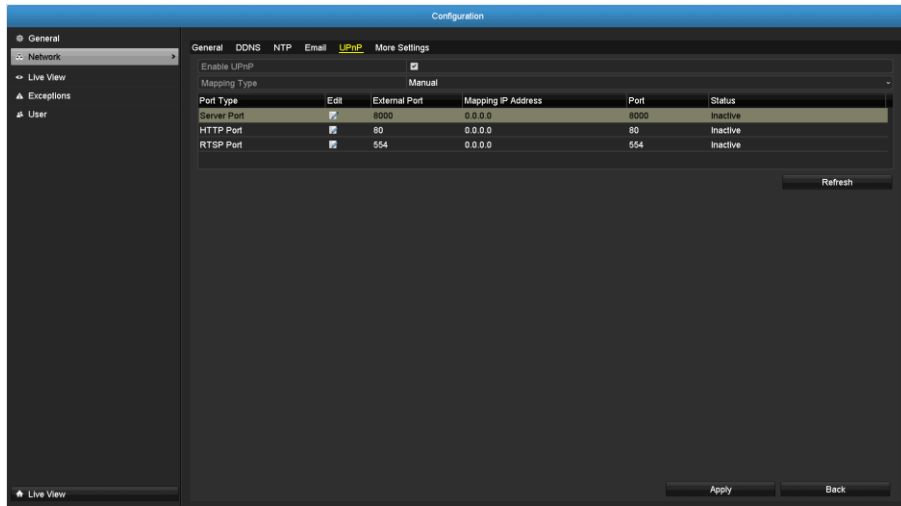

UPnP

Enable UPnP: Check this box to enable UPnP connection.

Mapping Type: Choose **Manual** or **Auto** port mapping.

UPnP List

Port Type: The service type on the UPnP port

Edit: Click the icon to manually edit the port mapping.

External Port: Choose the port number for mapping.

Mapping IP Address: 0.0.0.0 is the TV-NVR104 self-address.

Port: Local port number.

Status: UPnP Status.

Click **Apply** to apply the changes.

More settings

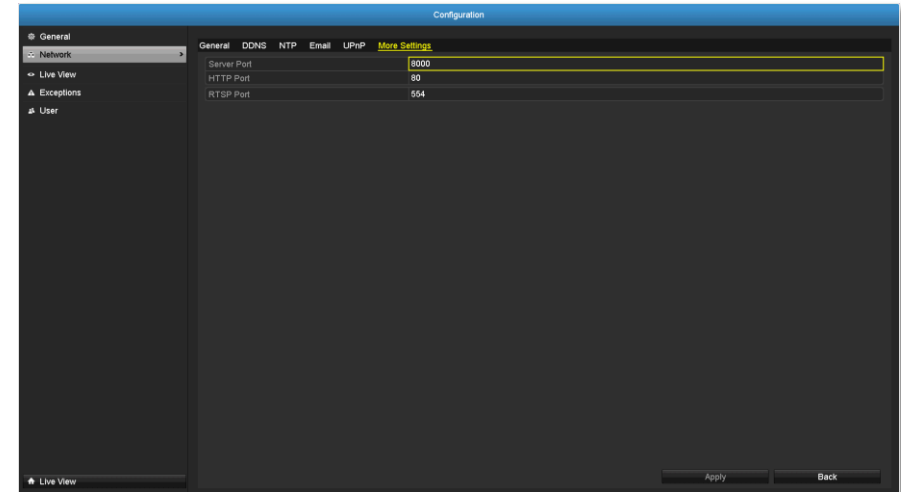

More Settings

Server Port: The service port number for NVR management. The default service port of TV-NVR104 is 8000.

HTTP Port: The default web access port. You can change the port number. The default port number is 80.

RTSP Port: The Real-Time Streaming Protocol port for video streaming. You can change the port. The default port number is 554.

Click **Apply** to apply the changes.

Live View

Change the live view settings.

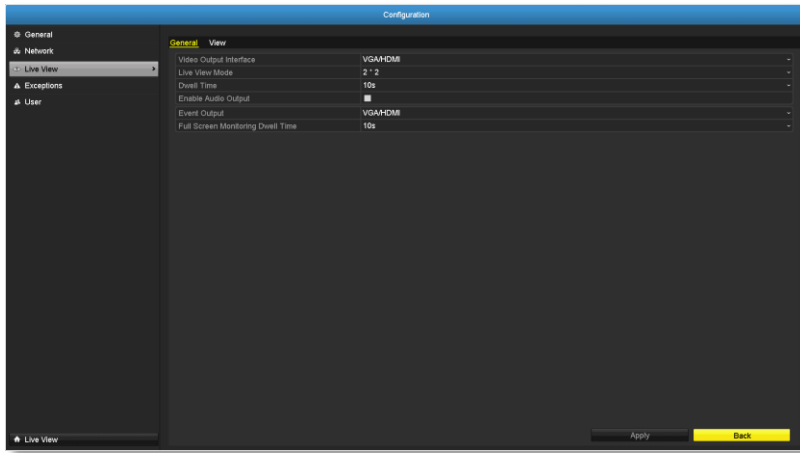

Full Screen Monitoring When event triggered full screen display, how long the video is going to stay on the screen.
Dwelling Time: Default: 10 seconds.

Click **Apply** to apply the changes.

General

Live view general settings

Video Output Interface: The video output interface is VGA or HDMI

Live View Mode: Choose the default **Live View** mode to be **1x1** single video on the screen or **2x2** four video on the screen at the same time. Default: 2x2.

Dwell Time: Set up how long each display will be showed up on the screen. There's no effect on 2x2 display mode. On 1x1 mode, each video will be shown on the screen for **Dwell Time** and then change to the next video. Default: 10 seconds.

Enable Audio Output: Enable or disable audio output on the NVR. Default: disabled

Event Output: Define where the video is going out when event triggered. The TV-NVR104 is set to both VGA and HDMI.



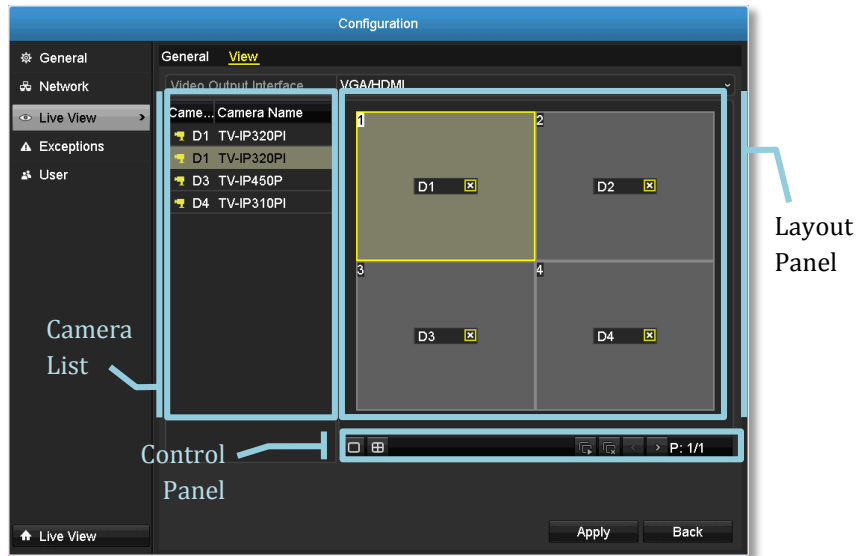

View

Setting live view display arrangement and sequence.



NO LINK. To remove the **NO LINK** message, just remove the channel assignment on the display cell.

Control Panel:

-  : Single channel display
-  : Quad channel display
-  : Automatic channel assignment
-  : Remove all channel assignments
-  : Previous page
-  : Next Page
- P: 1/1** : Current page / Total page

Note: In single channel display, you can set up the display sequence with the page numbers.



Click **Apply** to apply the changes.

Live View Layout and Sequence Settings



Video Output Interface: The video output interface is VGA or HDMI

Camera List: Installed cameras will be listed here by channel.

Layout Panel: Preview how the layout the video display.

To remove a camera from the display, just click  on the selected cell **D3**  to remove the channel number. **X** 

To assign a channel to a display cell, choose the camera from the camera list.

Note: Each video channel can be assigned to one display cell. Click on camera when it is not assigned  and double click on the list if it is currently assigned  to other display cell.

NO LINK: If you assign a channel to a display cell and there's no video stream, the cell is showing

Exceptions

Setup the action when exception happened. Select the exception you want to monitor and then choose the audible warning or email notification. Click **Apply** to apply the changes and remember to setup your email account if you choose the email notification (see page 49 for set up details.)

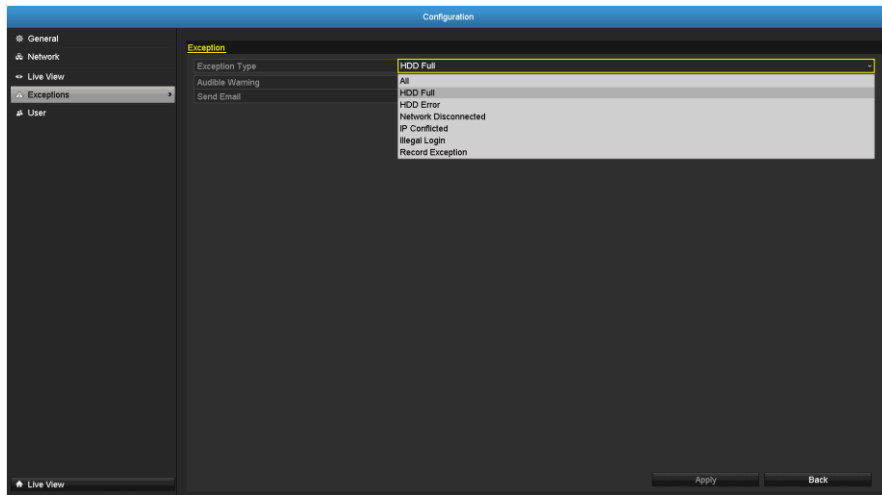

Exception Type

All: Any of the following exceptions will trigger the notification.

HDD Full: By default, the recording video does not overwrite when the hard drive is full. You can set up an audio warning or send email to system manager to remove the recording. (You can also setup the NVR for automatic overwrite the recordings when the disk is full. Please see page 75 for more detail.)

HDD Error: When the hard drive reading or writing error, the NVR can make audible sound or send email to system manager for the error. You can use the

hard drive maintenance tools on the NVR checking and managing your hard drive. See page 67 for more detail.)

Network Disconnected: The exception is triggered when network port is disconnected.

IP Conflicted: The NVR is constantly monitoring if there's an IP conflict is happening. Exception is triggered when there's an IP conflict.

Illegal Login: Exception is triggered when NVR detect the attempt login with wrong credential.

Record Exception: Exception will be triggered when anything goes wrong during video recording process.

User Accounts

You can setup up to 16 user accounts to access the camera's video stream with a web browser or real time video stream (RTSP). Only one administrator account (username: **admin**) can be setup to configure the TV-NVR104 and cannot be deleted.

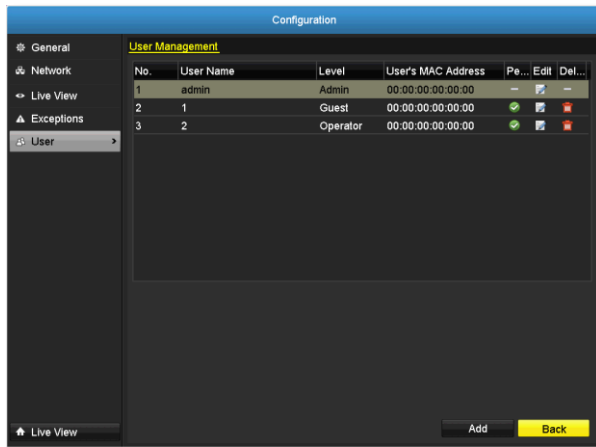

Add

Click **Add** button to add an account

Add account

User: Enter the user name.

Password: Enter the password.

Confirm: Enter the password again.

Level: Select the user's level from **Guest** or **Operator** for the preset permissions.

User's MAC Address: Enter the user's MAC address limit the access to add on security. Leave it 00:00:00:00:00:00 as wild card address

if you don't limit the access.

Edit

Click **Edit**  on user to change the account settings.

Permission

Click **Permission**  on user to change the account permission settings.

Permission: Local configuration

Local Log Search:	Search the NVR log with local login.
Local Parameters Settings:	Setting NVR with local login.
Local Camera Management:	Manage cameras on NVR with local login.
Local Advanced Operation:	Setting NVR advanced features with local login.
Local Shutdown / Reboot:	Access the shutdown menu with local login.

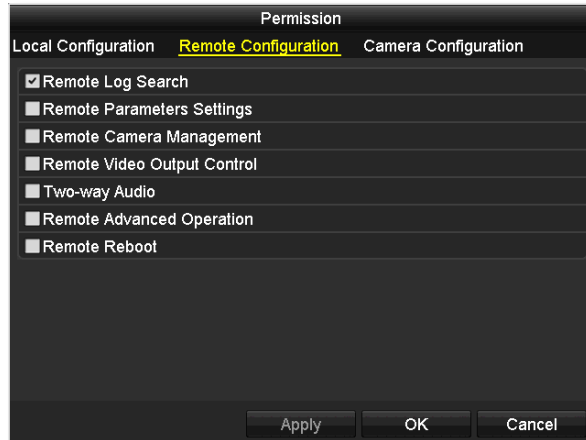
**Permission: Remote configuration**

Remote Log Search:	Search the NVR log with web login.
Remote Parameters Settings:	Setting NVR with web login.
Remote Camera Management:	Manage cameras on NVR with web login.
Remote Advanced Operation:	Setting NVR advanced features with web login.
Web Shutdown / Reboot:	Access the shutdown menu with web login.

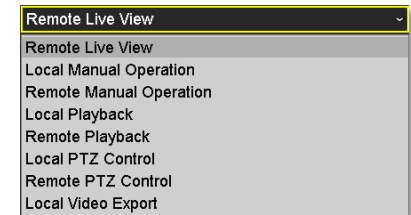
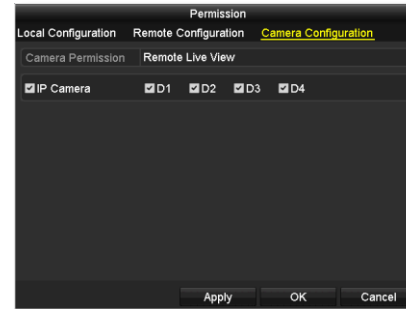
**Permission: Camera configuration**

Camera Permission:	The camera management permission list:
Remote Live View:	Viewing video through the network.
Local Manual Operation:	Manage camera settings with local NVR login.
Remote Manual Operation:	Manage camera settings with web login.
Local Playback:	Allow recording playback on connected monitor.
Remote Playback:	Allow recording playback via network access.
Local PTZ Control:	Allow camera PTZ operations through NVR with local NVR login.
Remote PTZ Control:	Allow camera PTZ operations through the network.
Local Video Export:	Allow exporting video through USB port.
Channels:	Select D1 ~ D4 channels to apply the permission to selected channel(s). Select IP Camera for all channels.

Click **Apply** to apply the changes.

System Maintenance Menu

Manage your NVR system by bring up the main menu. Click on **System**

Maintenance Menu  icon.

System information

System Information is displaying here for system maintenance.

NVR information

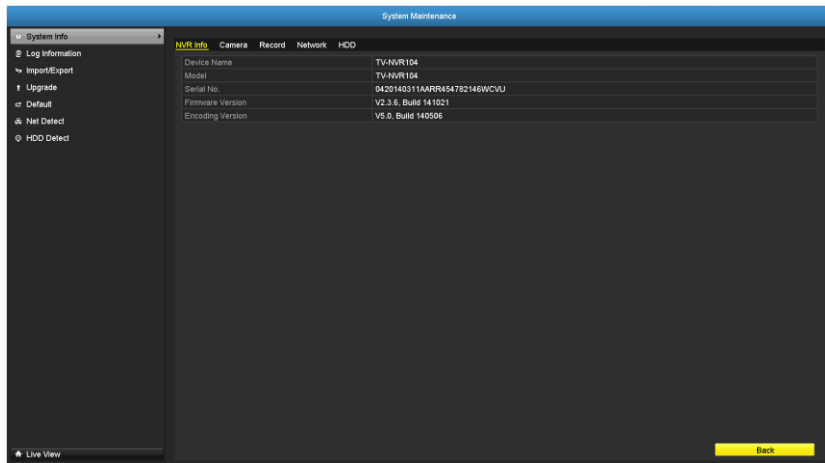

NVR Information

Device Name: Human readable device name for easy identification. You can change this name in System configuration > More settings on page 47.

Model: The model name of the TV-NVR104.

Serial Number: The unique identification number of this device.

Firmware Version: Firmware version

Encoding Version: Encoding version

Encoding Version: Encoding version

Camera information

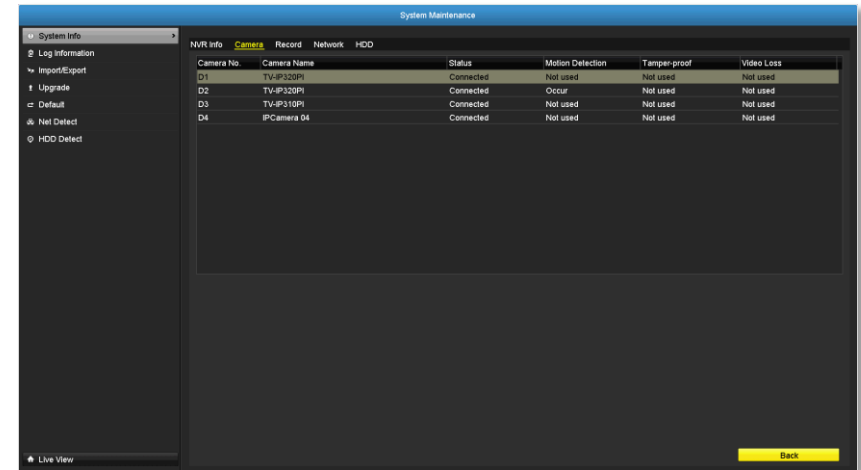

Camera Information

Camera No.: The channel number camera assigned into.

Camera Name: Camera device name

Status: Showing the camera is connected or disconnected.

Motion Detection: Showing the status and setup of the camera motion detection.

Tamper-proof: Showing the status and setup of the camera video tamper detection.

Video Loss: Showing the status and setup of the video loss detection.

Recording Information

Camera No.	Recording Status	Stream Type	Frame Rate	Bitrate(Kbps)	Resolution	Record Type	Encoding Parameters
D1	Used	Video	30fps	2048	1280*720(HD/720P)	Continuous	Continuous
D2	Used	Video	30fps	1024	1280*720(HD/720P)	Continuous	Event
D3	Used	Video	30fps	4096	1280*1920(1080P)	Continuous	Continuous
D4	Used	Video & Audio	30fps	4096	1280*1080	Continuous	Continuous

NVR Recording Status Information

Camera No.: The channel number camera assigned into.

Recording Status: Showing the status and setup of the video recording.

Frame Rate: Showing the camera recording frame rate.

Bitrate: Showing the camera recording video stream bitrate in thousands bits per second.

Resolution: Showing the camera recording video resolution.

Record Type: Showing the type of recording.

Encoding Parameters: Showing the encoding parameters.

Network Information

NIC	LAN1
IPv4 Address	10.10.10.14
IPv4 Subnet Mask	255.255.255.0
IPv4 Default Gateway	10.10.10.254
IPv6 Address 1	fe80::caeb:57ff:fecc:80e64
IPv6 Address 2	
IPv6 Default Gateway	
Preferred DNS Server	10.10.10.254
Alternate DNS Server	
Enable DHCP	Enabled

NVR Network Interface Information

NIC: Network Interface Card. LAN1 is the assigned network interface which represent to the non-PoE network port.

IPv4 Address: The IPv4 address on this interface

IPv4 Subnet Mask: Network range of the subnet

IPv4 Default Gateway: The default route going further from TV-IP320PI IPv4 subnet

IPv6 Address 1: IPv6 self-assigned address including the subnet prefix expression in the end of the string.

IPv6 Address 2: IPv6 static address including the subnet prefix expression in the end of the string.

IPv6 Default Gateway: The default route going further from IPv6 subnet

Enable DHCP: The IP address is assigned by DHCP server or not.

Hard Disk Storage Information

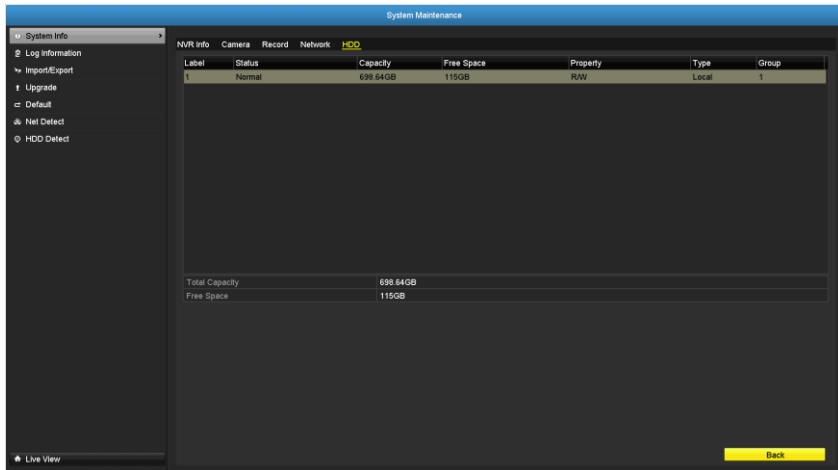

HDD Status Information

Label: Index of the HDD. TV-NVR104 has only one hard drive which is assigned on number one.

Status: Showing the hard drive working condition.

Capacity: The total hard drive storage capacity after formatting.

Free space: Displays how much space is available free for video recordings.

Property: R/W: Allow read and write.

Type: Local: The hard drive is installed on the NVR.

Group: The HDD on NVR is assigned to the group 1.

Log Information

All NVR activities are registered on the log. Find the activity by searching with time range and log type. Click **Search** to start the search.

Log Search



Log Search

Start Time: The starting time of a log search.

End Time: The end time of the time range for the log search.

Major Type: Filter the search by type of logs: all, alarm, exceptions, operation, and information.

Minor Type: Filter the search by type of logs. Select the major type and then choose the minor type.

Alarm: Start motion detection, stop motion detection, start temper-proof, stop tamper-proof, and IP Camera Alarm.

Exception: video loss, illegal login, HDD full, HDD error, IP conflict, network disconnect, recording exception, IP camera

disconnection, IP camera address conflict, recording buffer overflow.

Operation:

- power on, abnormal shutdown
- **Local operations:** shutdown, reboot, login, logout, configure parameters, upgrade, start recording, stop recording, PTZ control, lock file, unlock file, initialize HDD, add IP camera, delete IP camera, set IP camera, playback by file, playback by time, export configuration file, import configuration file, export recordings, restore administrator's password, operate tag, and HDD detect.
- **Remote operations:** reboot, login, logout, configure parameters, upgrade, start recording, stop recording, PTZ control, lock file, unlock file, initialize HDD, add IP camera, delete IP camera, set IP camera, playback / download by file, playback / download by time, export configuration file, import configuration file, export recordings, interrogate parameters, interrogate working status, start-two way audio, stop two-way audio, alarm arming, alarm disarming, and operate tag.

Information: local HDD information, HDD S.M.A.R.T. start recording, stop recording, delete expired recording, and system running status.

Export

Click **Export** on this page to export log on the list.



Click **Export** again to export the log to the USB drive of your choice. Select the USB drive on the **Device Name** and then click **Refresh** if you want to change the drive. Click **New Folder** to create a new folder on current directory. Click **Format** to format this USB storage.

Log Export

To export all logs saved on NVR, click the **Log Export** tab, select the hard drive, and then click Export.

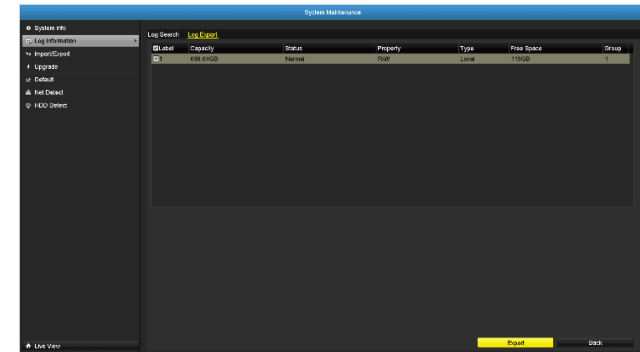

Click **Export** again to export the log to the USB drive of your choice. Select the USB drive on the **Device Name** and then click **Refresh** if you want to change the drive. Click **New Folder** to create a new folder on current directory. Click **Format** to format this USB storage.

Save and Load NVR System Settings

To save current or load previous TV-NVR104 settings, choose the **Import / Export** page and then export the file to the USB drive or import the file.

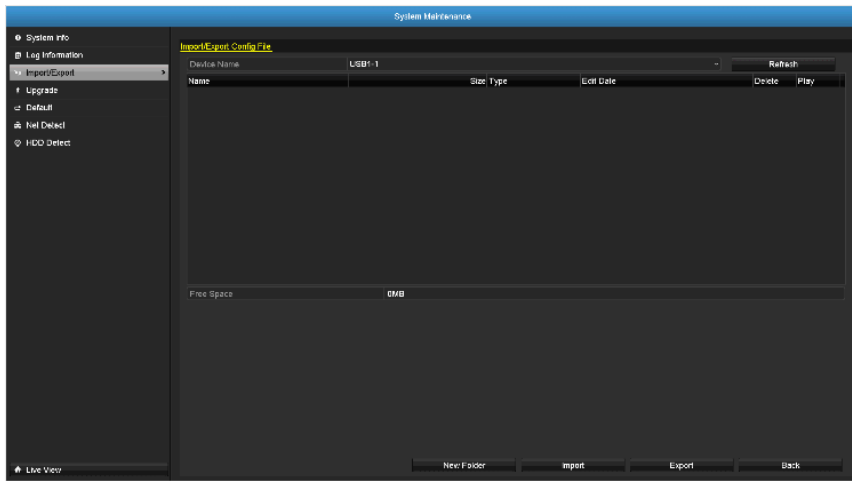

Click **Export** to export the settings to a file on the USB drive of your choice. Select the USB drive on the **Device Name** and then click **Refresh** if you want to change the drive. Click **New Folder** to create a new folder on current directory. Click **Format** to format this USB storage.

Firmware Upgrade

Local Upgrade

TRENDnet may periodically release firmware upgrades that might add features or fix problems associated with your TRENDnet model and version. To find out if there is a firmware upgrade available for your device, please check your TRENDnet model and version using the link.

<http://www.trendnet.com/downloads/>

1. If a firmware upgrade is available, download the firmware to your computer.
2. Unzip the file to a folder on your computer.
3. Read the firmware upgrade instruction for specific version update information.
4. Log into the TV-NVR104K.
5. Getting to this Maintenance page to upgrade firmware.

Extract the firmware file from the downloaded zip file and then save it to the USB drive. Plug in the USB drive to one of the available USB slot on the NVR. Choose **Upgrade** page and then click on **Upgrade**.

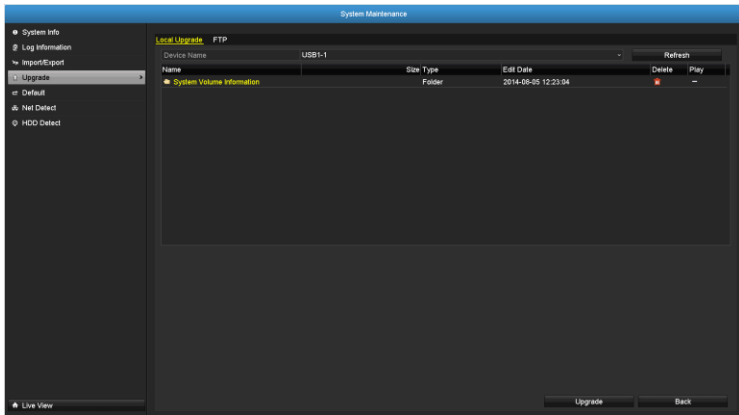

Remote Upgrade

You can setup the upgrade over the network with FTP protocol. To proceed FTP upgrade, you need to prepare a FTP server on the local network with username: **ftp** and password: **ftp**. Place the firmware file on the root directory when the **ftp** account is logging in the FTP server.

Navigate to the remote upgrade (**FTP**) page. Enter the FTP server address, and then click on **Upgrade**.

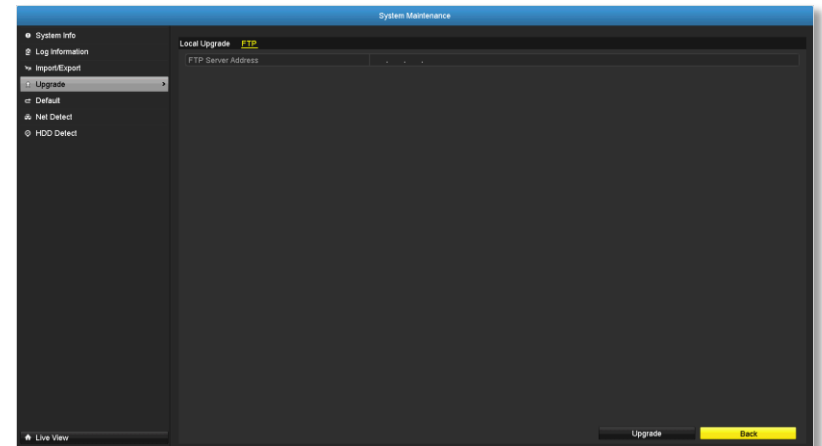

Factory Default

To reset your TV-NVR104 to the factory default, navigate to this **Default** page and then click on **OK** to reset all TV-NVR104 settings back to factory default.

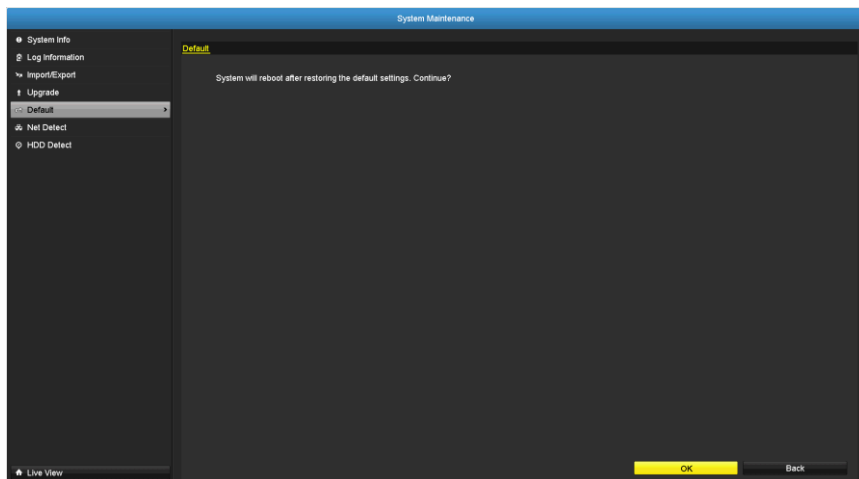

Network Monitoring

Traffic

To monitor the network traffic, navigate to the traffic chart.



Traffic

LAN1: The network interface.

Sending: The network traffic generated from the NVR.

Receiving: The network traffic receiving by the NVR.

Link Status: The network linking status.

Type: Type of network, Ethernet.

MAC Address: Media Access Address of the network interface.

MTU: Maximum Transmission Unit in bytes.

NIC Type: Type of the network card. Speed and duplexing.

Network Tools

Use network tools (Network Detection) on the NVR to test the network status.

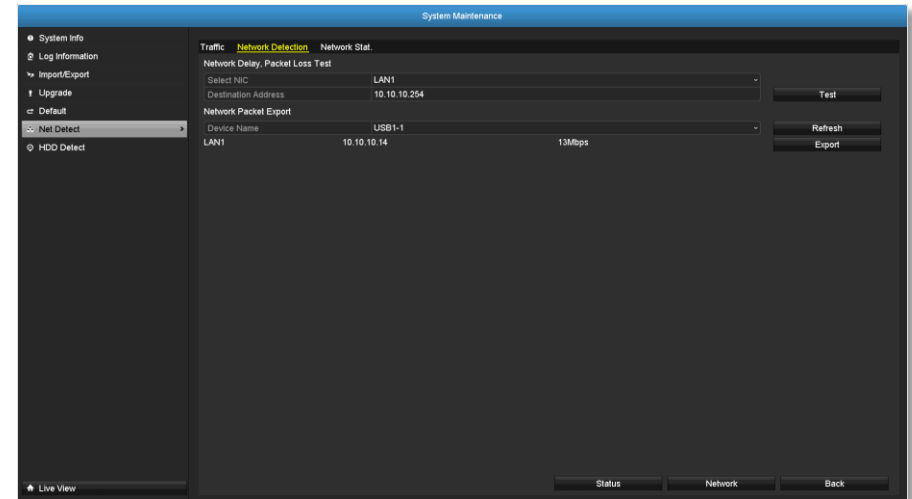

Network delay and packet loss test

The basic PING test tool. Enter the testing destination IP address and then click on the **Test**.

Network Delay, Packet Loss Test

Select NIC: LAN1

Destination Address: 10.10.10.254

Test

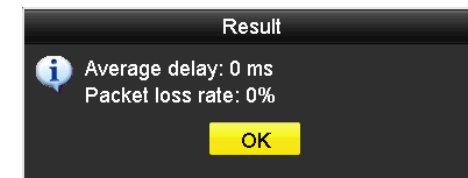

Network packet export

Capture packets and save to external USB storage for network analysis. Plug-in your USB network drive and then click Export to export the packet capture files. Click Refresh to list the directory on your USB storage again.

Network Packet Export

Device Name	USB1-1	Refresh
LAN1	10.10.10.14	13Mbps
		Export

Network Statistics

To review the network statistic information, navigate to the **Network Statistics** page. Click **Refresh** to update the information.

The screenshot shows the 'System Maintenance' interface with the 'Network Statistics' page selected. The page displays a table of network traffic statistics and a 'Refresh' button.

Type	Bandwidth
IP Camera	16Mbps
Remote Live View	0bps
Remote Playback	0bps
Net Receive Idle	9.216Kbps
Net Send Idle	40Mbps

Refresh

Hard Drive Maintenance

S.M.A.R.T Settings

The S.M.A.R.T. (Self-Monitoring, Analysis and Reporting Technology) is a monitoring technology to detect and report on various performance and reliability factors to help predict and prevent disk failures.



Power on days: Days the hard drive is on.

Self-evaluation: The result of self-evaluation.

All-evaluation: Functional evaluations.

S.M.A.R.T. Information: Detailed S.M.A.R.T. hard drive information.

S.M.A.R.T. Settings

Continue to use: Check the **Continue to use this disk when self-evaluation is failed** if you want it to do so. Click **Apply** if you change this setting.

HDD: The Disk number. The TV-NVR104 has one HDD.

Capacity: The total hard drive storage capacity after formatting.

Self-test Status: Showing the self-testing status.

Self-test Type: Choose a type of S.M.A.R.T. test: short, expanded, and conveyance tests.

S.M.A.R.T.: Click  to start S.M.A.R.T. test.

Temperature: The temperature of the hard drive in Celsius.

Bad Sector Detection

Detect if there's any bad sector on the disk drive.

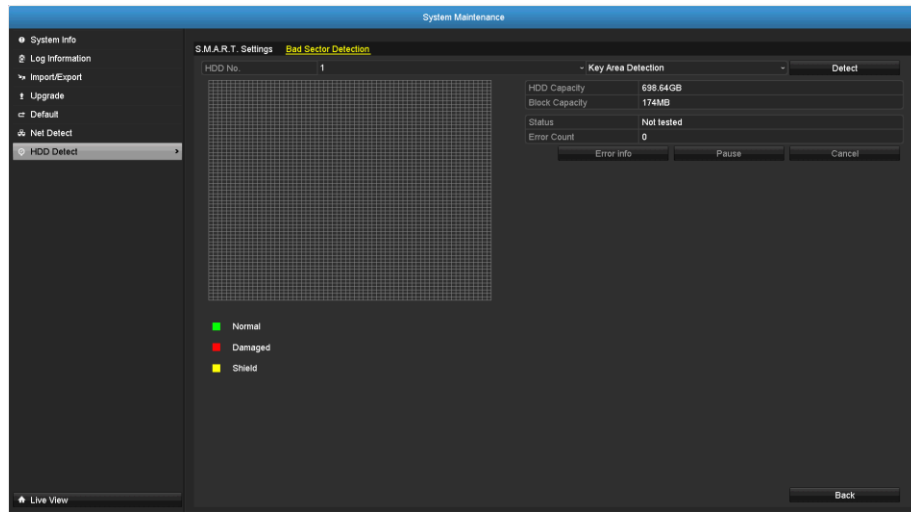

Bad Sector Detection

HDD No.: The Disk number. The TV-NVR104 has one HDD.

Capacity: The total hard drive storage capacity after formatting.

Type of Detections: Select key area detection or full detection.

Detect: Click this button to start bad sector detection.

HDD Capacity: The storage capacity of the hard drive.

Block Capacity: The block capacity.

Status: The status of bad sector detection.

Error count: The total error count detected.

Error Info. Detailed sector damage or shield information.

Pause: Pause the bad sector detection once it start running.

Hard Drive Management

Manage and allocate your storage space by bring up the main menu. Click

on **HDD Maintenance Menu**  icon.

Format/Initiate the Hard Drive

Select the hard drive and then click on **Init** to format and initialize the hard drive.

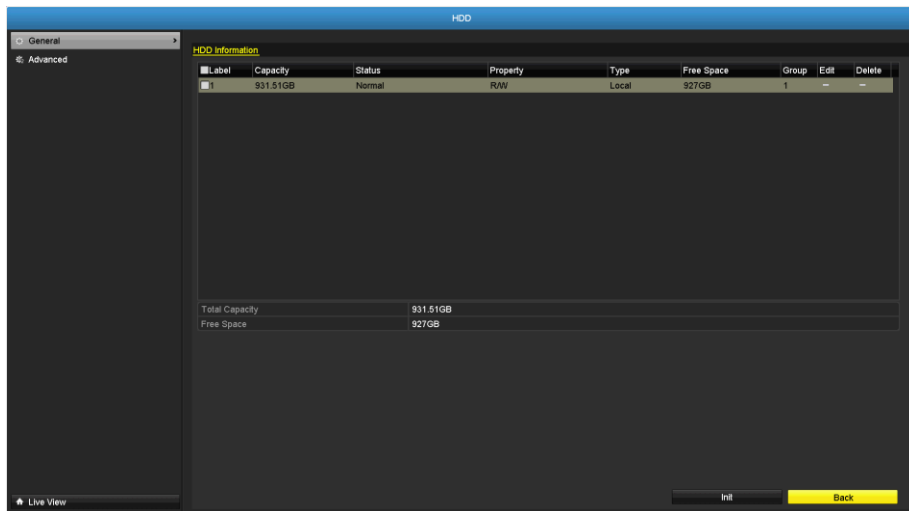

Advanced Storage Quota Settings

To set up the disk quota for each channel video recording, select the camera and then enter the maximum recording capacity.

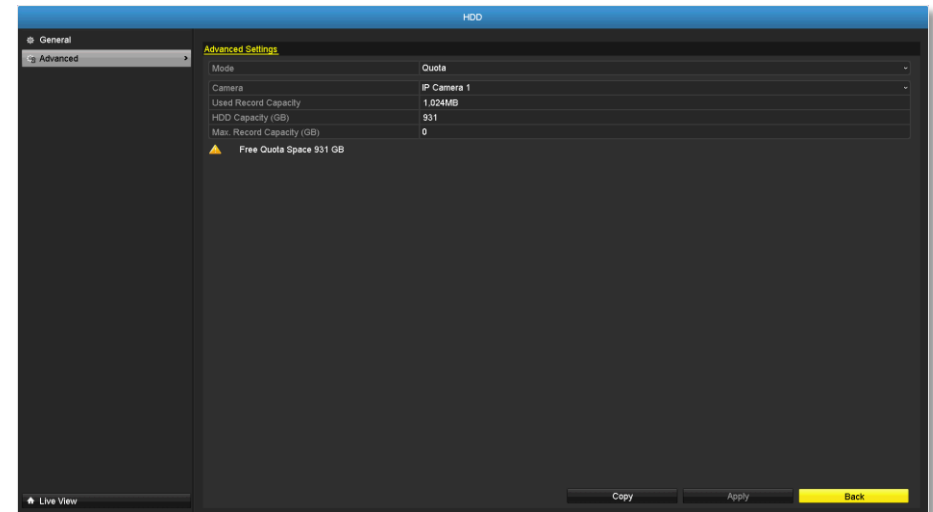

Storage quota settings

Mode: Quota setting

Camera: Select the camera you want to setup the storage quota.

Used Record Capacity: The storage space spend in recording for the specific channel.

HDD Capacity: The storage capacity of the hard drive.

Max. Record Capacity: Allocate the recording space to selected video channel in gigabytes.

Click **Copy** to copy the same quota setting to other channel.

Click **Apply** to apply the changes.

Scheduled recording

Setup the video recording settings by bring up the main menu. Click on

Scheduled Recording Menu icon.

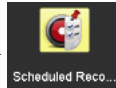

Schedule

Select the video channel, type of recording, and then click and drag on the weekly schedule. Click **Edit** to bring up the detailed schedule setting table or click **Copy** to copy the same schedule to other channel.

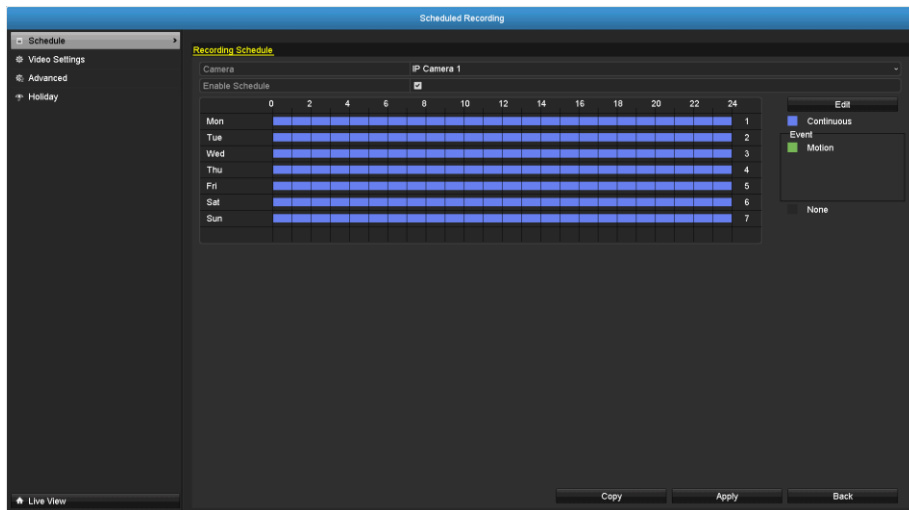

1. Select channel.

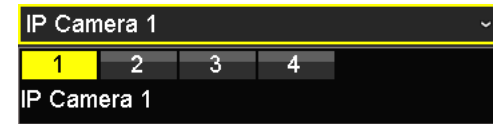

2. Select recording type. Choose from **Continuous** or **Motion** recording. If you want to clear out some scheduled recording time, choose **None**.

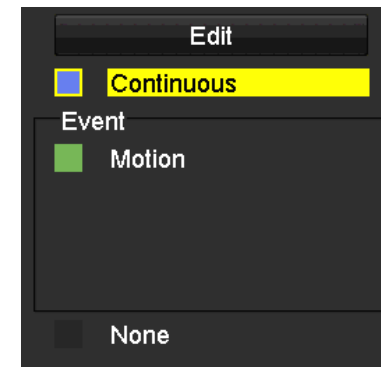

- Select the time slots you want to make the scheduled recording. Each time slot represents a half hour interval. The row number represents the week of the day starting from Monday.

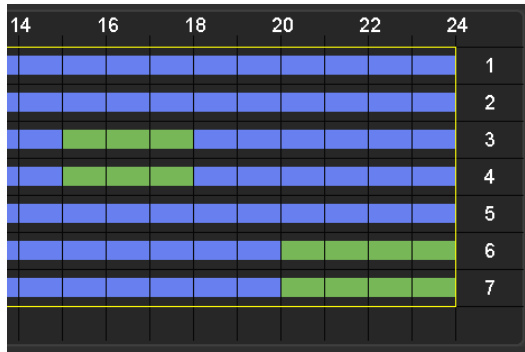

- If you want to define the schedule in finer intervals, click on **Edit** button.

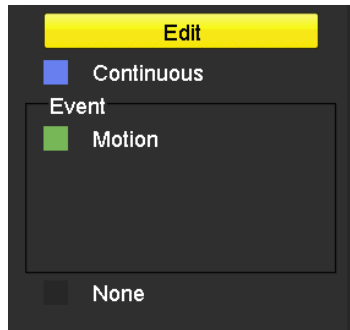

- Make your selection and then click **Apply** to apply the changes.

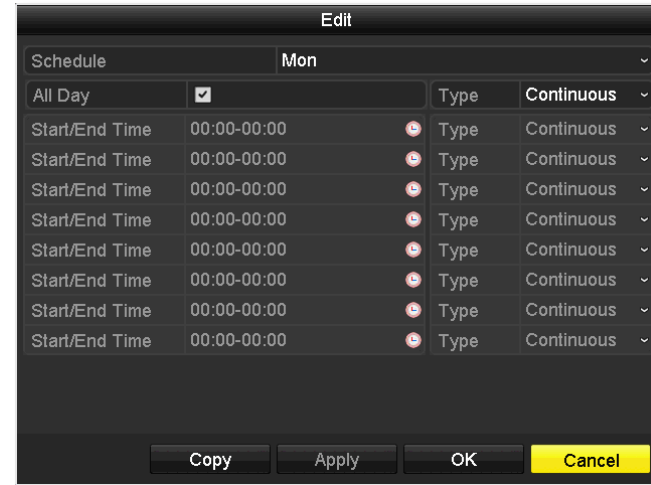

Schedule: Select the day of the week

All Day: Select if you want to setup the all-day recording.

Start/End Time: Specify the starting and end of recording time in 24-hour format.

Type: Select **Continuous** or **Motion Detection** recording

Copy to:

To quickly setup the same schedule over the week, click **Copy**. Click another day of the week (1: Monday, 2: Tuesday, 3: Wednesday, 4: Thursday, 5: Friday, 6: Saturday and 7: Sunday). Click **All** to select the whole week. Click **OK** after you select the day of the week you want to copy to.

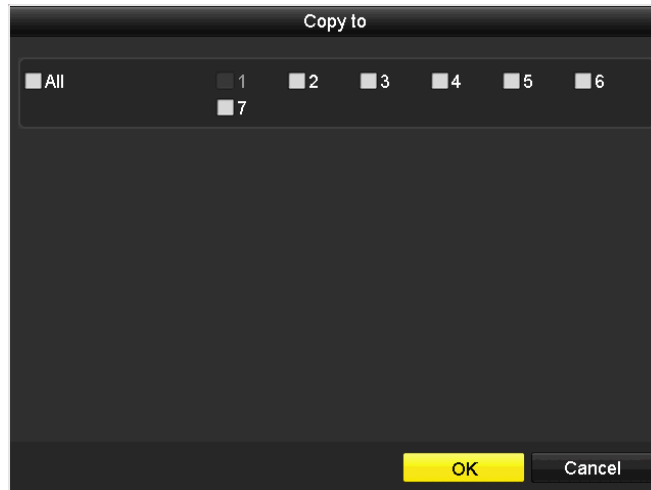

Video Settings

Set up the video quality for recording (main stream), the higher video quality require larger storage space and better network condition. Please choose the best profile of your choice.

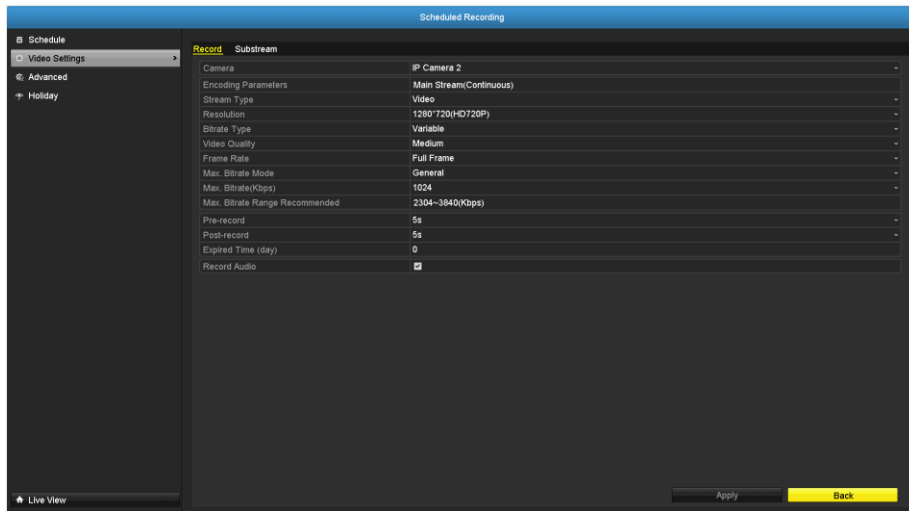

Note: Settings in this section are not available all cameras. The NVR will prompt the message to remind you the setting is not available on selected camera.

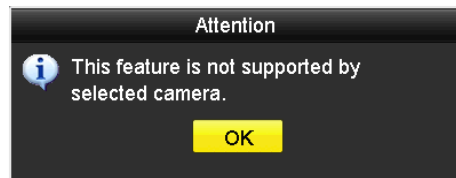

Main Stream (Record) Settings

Camera: Select the camera you want to change the recording video quality.

Encoding Parameters:	The type of video from the camera.
Stream Type:	Select you want to stream video only or video and audio.
Resolution:	Select the video resolution.
Bitrate type:	The bitrate is the rate of information generated from the video. The higher bitrate means more data and more traffic and better video quality. Constant bitrate generates same amount of information over the same period of time. Variable bite rate takes one step further to compress the information whenever it can, therefore, generates the same or lower amount of information compare to the constant bitrate.
Video Quality:	Select the video compression algorithm.
Frame rate:	Select the frame rate to decide how many pictures you want to take in each second.
Max. Bitrate Mode:	Select General to set the maximum bitrate in certain brackets. Choose Customized to set the maximum bitrate on your own.
Max. Bitrate:	The maximum information allowed to record on the NVR in thousands of bits per second.
Max. Bitrate Range Recommended:	Recommended bitrate setting.
Pre-Record:	If the recording is triggered by the motion event, this value specifies to start recording some period of time before the motion event happened.
Post-Record:	If the recording is triggered by the motion event, this value specifies to record video some period of time after the motion event happened.
Expired Time:	Lock the recording video for some period of time (in days) to prevent accidentally been overwrite or delete.
Record Audio:	Recording audio or not.

Sub Stream

The sub stream video is mainly for NVR live view. Change your camera option to lower resolution if your camera generates too much information to the NVR for live view.



Sub Stream

Camera: Select the camera you want to change the recording video quality.

Stream Type: Streaming type is video only.

Resolution: Select the video resolution.

Bitrate type: The bitrate is the rate of information generated from the video. The higher bitrate means more data and more traffic and better video quality. **Constant** bitrate generates same amount of information over the same period of time. **Variable** bite rate takes one step further to compress the information whenever it can, therefore, generates the same or lower amount of information compare to the constant bitrate.

Video Quality: Select the video compression algorithm.

Frame rate: Select the frame rate to decide how many pictures you want to take in each second.

Max. Bitrate Mode: Select **General** to set the maximum bitrate in certain brackets. Choose **Customized** to set the maximum bitrate on your own.

Max. Bitrate: The maximum information allowed to record on the NVR in thousands of bits per second.

Max. Bitrate Range Recommended: Recommended bitrate setting.

Advanced recording setting

Setup if the NVR can overwrite the previous video recording or not. If you checked this option, the NVR will overwrite old recordings when the disk is full. Otherwise the NVR will send **Disk Full Notification** to let administrator knows that the disk is full and cannot proceed any recording.

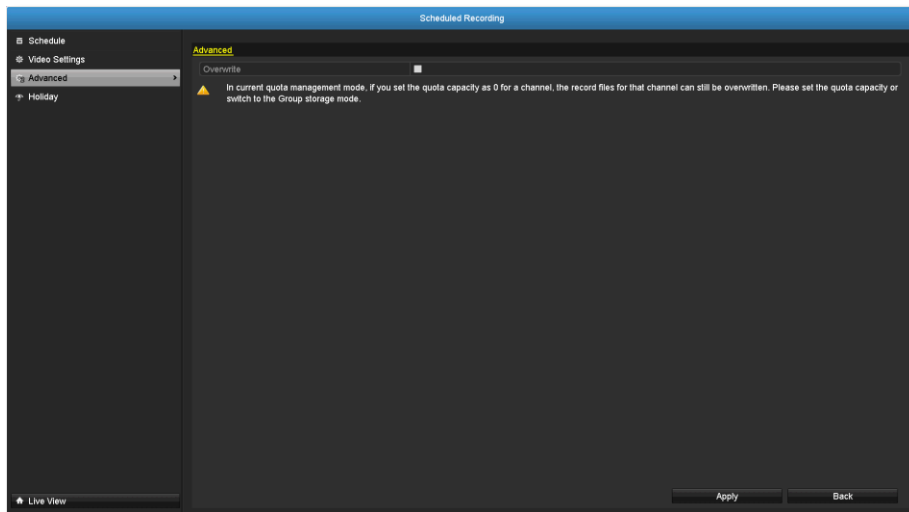

Holiday scheduling

Recording video in holidays may have different requirements. You can set up to 11 holidays of a year sharing the same holiday profile.

Set up the holiday schedule by clicking on  button.

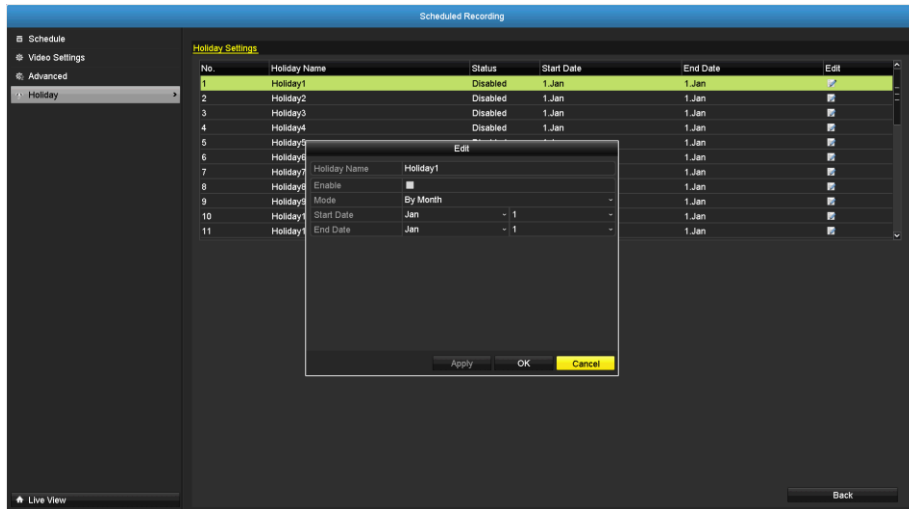

Edit Holiday Schedule

Holiday Name: Change the holiday name to meaningful name instead of index numbers.

Enable: Enable or disable this holiday rule.

Mode: Select the holiday is for a day, a week or a month.

Day mode: Select the start and end dates to specify the period of holidays. This setting is good for one time only. It does not repeat periodically.

Week mode: Select the start and end dates of the week to specify the period of holidays. This setting is repeating every year.

Month mode: Select the start and end dates to specify the period of holidays. This setting is repeating every year.

Start Date: Select the day when the holiday starts.

End Date: Select the day when the holiday ends.

Click **Apply** button to apply the change and click the **OK** button to finish the editing.

Backup Video Recordings

Quickly and backup and export your video recordings with the file exporting menu. Bring up the main menu then click on **Export Menu**

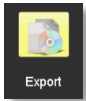

icon.

Export

Select the video channel and range of time and then click on **Search** to search the video you want to export. Click **Quick Export** if you want to export all video recordings.

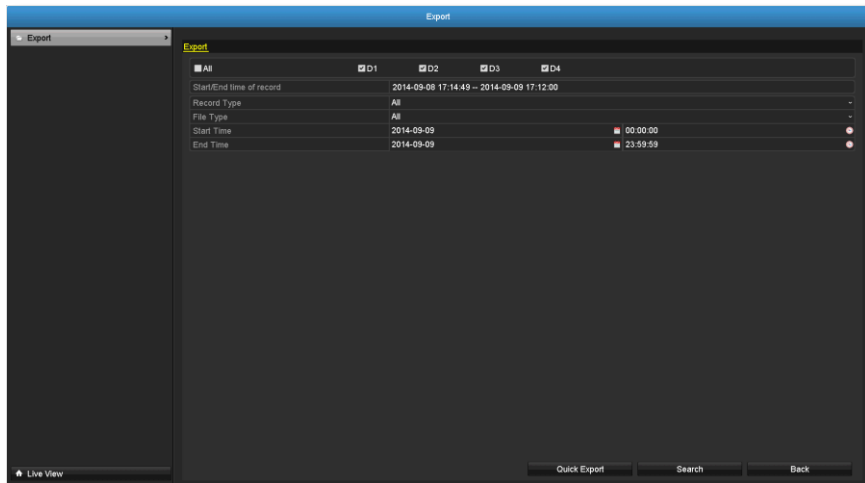

Quick export

Click **Export** again to export all the video recordings to the USB drive of your choice. Select the USB drive on the **Device Name** and then click **Refresh** if you want to change the drive. Click **New Folder** to create a new folder on current directory. Click **Format** to format this USB storage.



Export with search

Select the video clips you want to export by check or uncheck the video clip. Then click **Export** to export the video recordings.

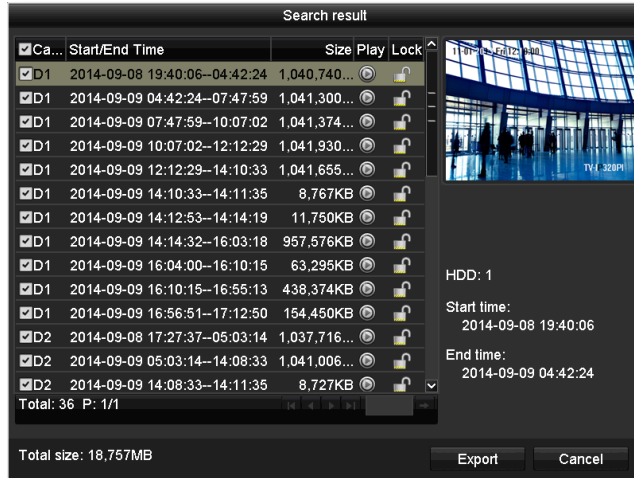

Click to preview the video clip.

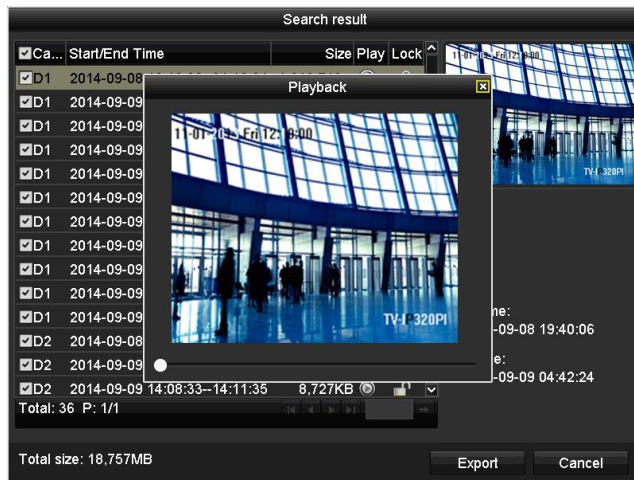

Click to lock the video clip. When video is locked, the video clip is not going to be overwrite accidentally. To unlock the video clip, click . The warning message will remind you again you are unlocking the video clip. Click **Yes** if you want to proceed unlock.

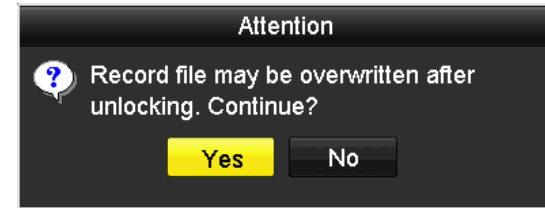

Click **Export** again to export the video recordings to the USB drive of your choice. Select the USB drive on the **Device Name** and then click **Refresh** if you want to change the drive. Click **New Folder** to create a new folder on current directory. Click **Format** to format this USB storage.



Video playback

Bring up the main menu then click on **Export Menu** icon.



Playback screen

The screenshot shows a video playback window with several labeled components:



- Type of Playback:** A dropdown menu in the top-left corner with options: Normal (selected), Event, Tag, and External File.
- Channel Selection:** A list on the right side of the window showing camera channels: TV-IP310PI, TV-IP321PI, TV-IP310PI, and TV-IP310PI.
- Live View:** The main video area showing a blue-tinted interior scene with people walking.
- Recording search:** A calendar widget in the bottom-right corner for September 2014, with a red dot on the 27th.
- Action Buttons:** A set of control buttons (stop, play, pause, etc.) at the bottom left of the video area.
- Playback Buttons:** A set of control buttons (rewind, play, fast forward, etc.) at the bottom center of the video area.
- Time Line:** A horizontal timeline at the bottom of the video area with numerical markers from 1 to 24.
- Scale Buttons:** A set of control buttons (full screen, zoom in, zoom out, etc.) at the bottom right of the video area.

Search for video recordings

Check on the camera you want to see the playback or check on **Camera** to select all channels. Then, choose the date for the recording. If there are video recording in selected channel, the date on the calendar will show blue. Double click the date to start playback.



Time line



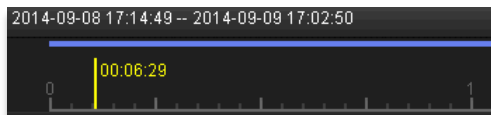





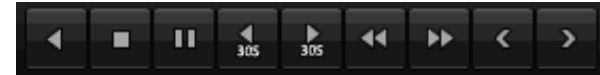

There is a play back head in the center of the time line represented in a yellow vertical line. To look for a specific video recording, move the play head by clicking and dragging it. If the recording is short, zoom in by clicking  button. Click  to zoom out the time scale.



Playback buttons

Use playback controls to play back the video recording.



-  Click this button to play the video backward.
-  Click this button to play the video.
-  Click this button to pause video playback.
-  Click this button to stop playback.
-  Click this button to skip forward 30 seconds.
-  Click this button to skip backward 30 seconds.
-  Click this button increase playback speed*.
-  Click this button decrease playback speed*.
-  Click this button to jump to the next day.
-  Click this button to jump to the previous day.

* Note: There are 5 steps of playback speed you can choose from: 1/4, 1/2, 1, 2, and 4 times of original speed.

Playback operations

More playback operations such as mute the audio, clip a customized video, add and manage tags, and zoom in the viewing are available on the action buttons section.

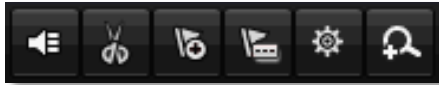

The audio is on. Click this button to mute the audio.



The audio is muted. Click this button to enable audio.



Click this button to start video clipping.



Click this button to stop video clipping. You can make multiple video clips. When you finish all clipping and exit the live view, the NVR will prompt and asking you to save the video clips.

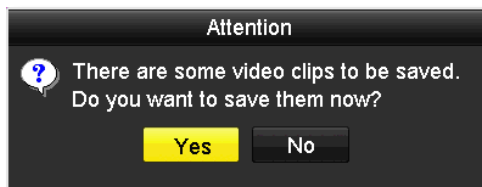

Click this button to add a tag with default tag name.



Click this button to add a tag with customized tag name.





Click this button to manage the tags



Click this button to zoom in the live view.

Tagging

Tagging on video recordings help you to mark the critical time of video recording and easier tracking and editing. Find the video is critical and click on  to make the tag with default tag name "tag". Click on  to make the tag with customized tag name. Search the video on **Tagged video playback mode** explained in following sections.

Zoom

Click  to zoom the playback. A navigate window will showed up on right lower screen corner. Drag and drop or double click to define the area you want to zoom in. The defined area is showed in red rectangular. Right click to exit the zoom mode.



Playback modes

The video playback not only can playback the video recorded on the hard drive indexed by the time. You can also search the video with motion detection event, tag, or playback the video stored on the USB external hard drive.

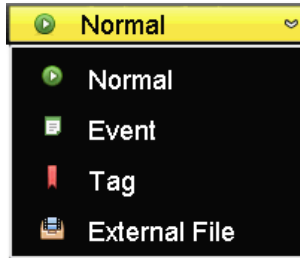



Event

To search video with motion detection event, click and select the **Event** playback mode.

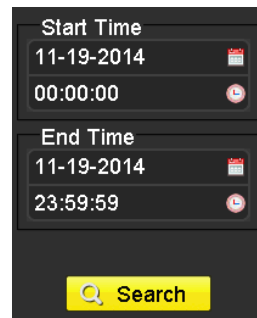
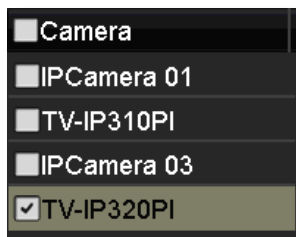

Select the channel you want to search the motion detection. Enter the start and stop time. And, then click on **Search**.



The motion recording events are showed on the list. Click  to view the video.

Use the scroll bar to browse the recordings and adjust the pre-play and post-play between 5 seconds and the maximum amount of a single section of recording to decide the length of playback before and after the motion event.

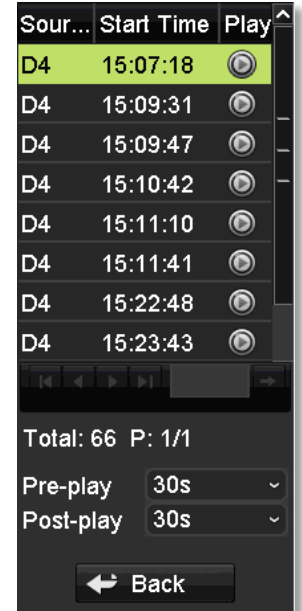
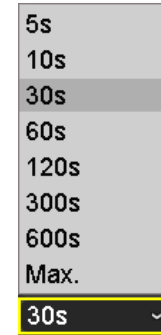

Tag

If you set up the tags and want to search video with the tags, click and select the **Tag** playback mode.



Select the channel you want to search the tags. Enter the start and stop time. If you want to search for specific tag name, enter the tag name or leave it blank for all tags. And, then click on **Search**.



The tags searched are showed on the list. Click to view the video.

Use the scroll bar to browse the recordings and adjust the pre-play and post-play between 5 seconds and the maximum amount of a single section of recording to decide the length of playback before and after the motion event.

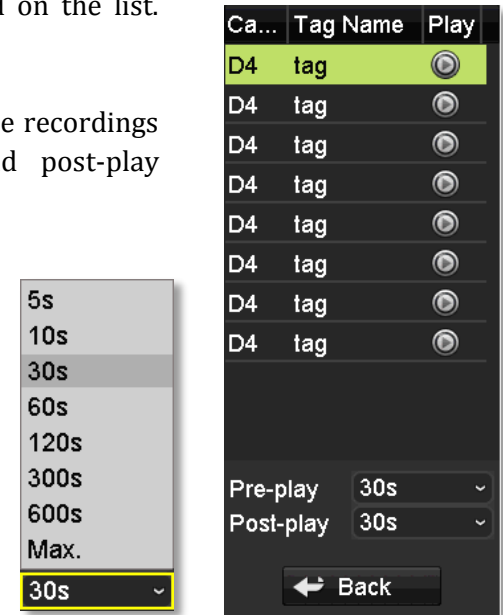

External file

To playback the video files saved on the USB drive, click and select the **External File** playback mode.



Select the USB device to browse the files. Click **Refresh** to update the list when necessary.



Click  to view the video and use the playback control to control the playback.

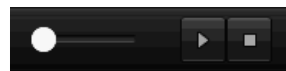

Access your NVR with the Web Browser

Default Settings and Factory Reset

To manage your TV-NVR104 through the web browser, you have to setup the network connection first. If you didn't set up your NVR attaching to your home/business network, please enable NVR's DHCP client (see page 48 for details). Click **Apply** and then restart the NVR. If you have already installed your cameras, you have to manually change their settings. (You don't have to do anything for plug-and-Play models connected directly on PoE ports.) Check the network status (see page 58 Network Information) when necessary to make sure the NVR gets the IP address from your network.

Here's the list of your NVR's factory default settings:

System Default	
Management IP:	192.168.10.60.
Administrator name:	admin
Administrator password:	admin

Note: If you are not having a brand new TV-NVR104, you may not know what password was setup on the NVR. In this case, you have to call our 24-hour tech support to get temporary access code to reset the NVR. See page 27 for more details.

System Requirement

To access you NVR with the browser, you need a Windows or OS X based computer and up-to-date browser (Internet Explorer, Safari, Chrome, or Firefox). A web browser plug-in must be installed to supported computer and browser to watch the video.

You need to setup the IP address in the same network of TV-NVR104. (192.168.10.x network or your home network). For example, setup your computer with 192.168.10.2 static IP address.

For **Windows** system, please go to the next paragraph.

For **OS X** system, please go directly to page 88.

Logging-in to the NVR for the First Time (Windows)

1. Connect your computer to you home network and look for the NVR by browsing your **Network** in **File Explorer** and then double click the icon to visit the NVR. (If your computer does not configured to find sharing resources, you can reference "Turn on

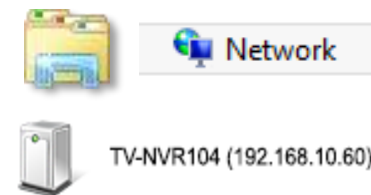

network discovery on Windows" on page 119.) Or, you can find the TV-NVR104 IP address assigned by your home gateway by visiting home gateway's web management page, and then press **Enter**.

2. Enter the user name, **admin**, and the password you setup through the basic setup. If you didn't setup your password, the change password

window will pop up on step 9 to guide you through the password changing. The default password is **admin**.

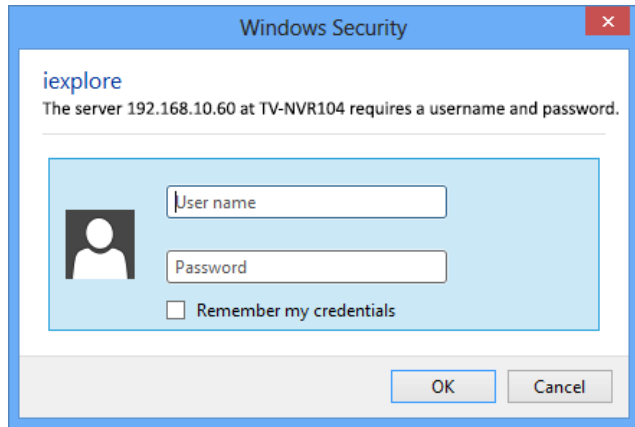

3. The NVR management page will detect if you installed the camera video streaming plug-in or not. Click the link to download the plug-in from TV-NVR104.

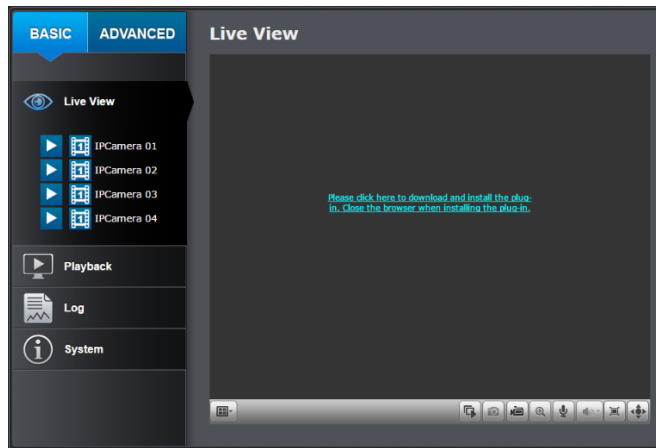

4. Download the plug-in to your computer and then and close your browser. Launch the plug-in installation to install the plug-in.



5. Permission request may show up depends on the Internet security settings on your computer. Click **More Info** and then **Run anyway** to install the plug-in.

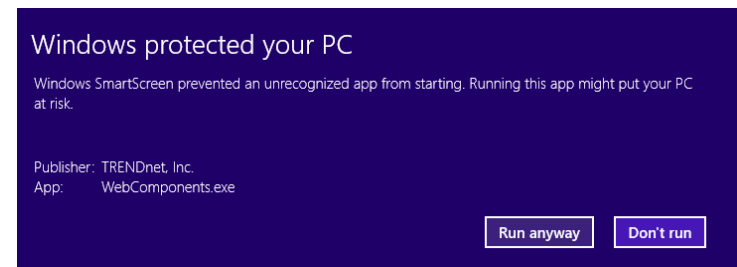
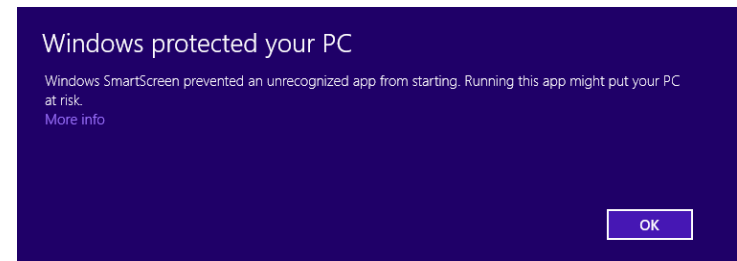

6. Click **Next** to install the plug-in.

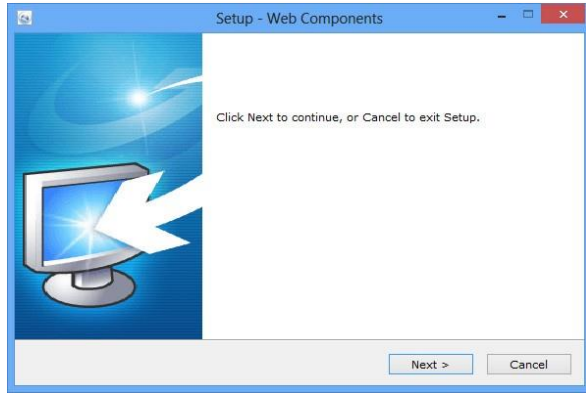

7. Click **Finish** to finish the installation.

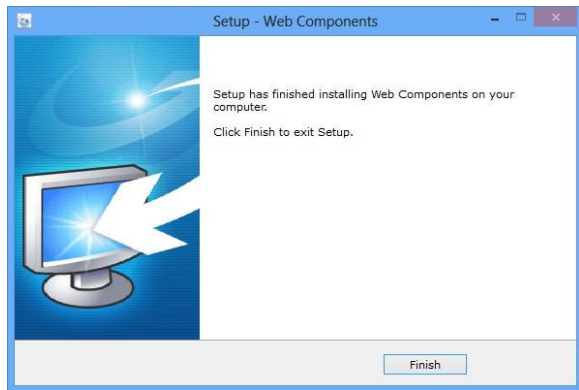

8. Open the browser and login again.

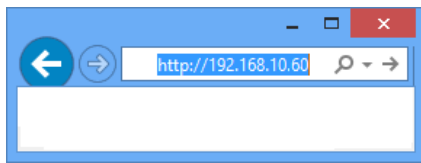

9. (Go to step 11 if you already changed your password). The TV-NVR104 will ask you to change your password from default setting. Please enter the new password twice and click **OK**. The password must be between 8 and 16 characters. (Alphanumeric: a-z, A-Z, 0-9, !, @, #, \$).

PLEASE ENTER YOUR NEW ADMINISTRATOR PASSWORD	
User Name	admin
Password	*****
Confirm	*****
<input type="button" value="OK"/>	

10. Enter the user name **admin** and new password again to start secured session.

Windows Security	
iexplore	
The server 192.168.10.60 at TV-NVR104 requires a username and password.	
<input type="text" value="User name"/>	<input type="password" value="Password"/>
<input type="checkbox"/> Remember my credentials	
<input type="button" value="OK"/> <input type="button" value="Cancel"/>	

11. The **Live View** page will show up and begin streaming video.

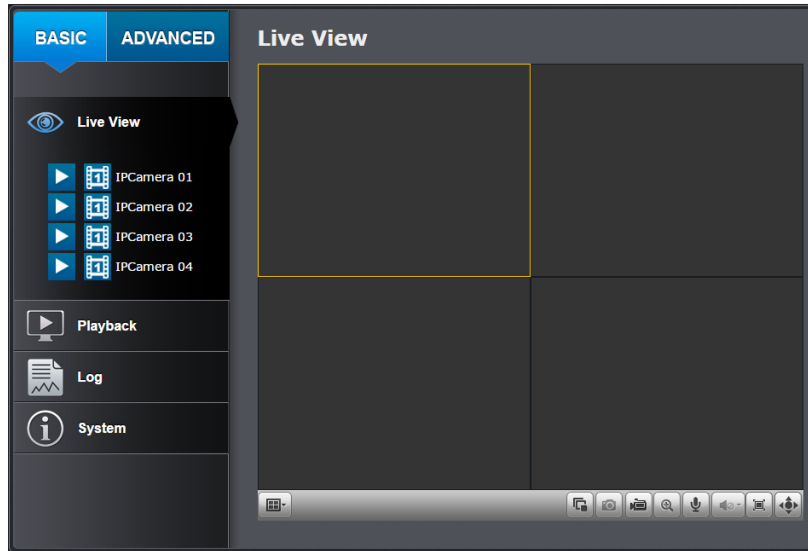

Note: If you were not go through the basic setup, the camera plug-and-play process will begin after you setup the password. Wait a few minutes and press F5 to refresh the browser for the live video.

Logging-in to the Camera for the First Time (OS X)

1. Open the web browser on your computer. In the address bar, enter the IP address of the camera 192.168.10.60. (If you have a DHCP server on your network, the IP address will be assigned dynamically. For example, if you have a home gateway on your network and you plug-in the camera on the same network, then you can find the camera IP address on your home gateway), and then press **Enter**.

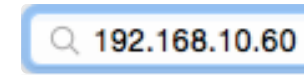

2. Enter the user name, **admin**, and the default password, **admin**, and then click **OK**.

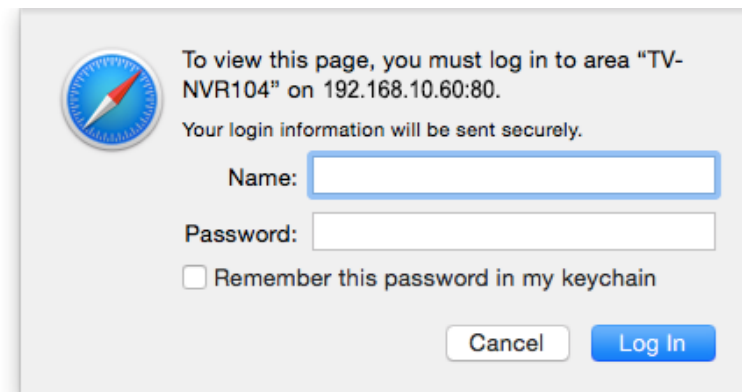

- The camera management page will detect if you installed the camera video streaming plug-in or not. Click the link to download the plug-in from the TV-NVR104.

*Note: Internet connection is required to download the plug-in. If you do not have Internet access, you can find the plug-in on the CD comes with the package under **/Mac** folder.*

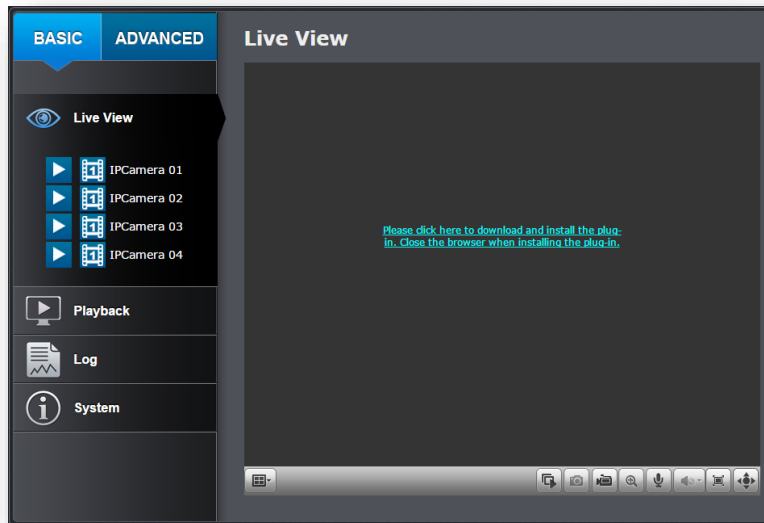

- Quit your browser completely by **command-Click** on the browser icon and then click **Quit** before installing the plug-in.



- Go to the **Finder** and navigate to the **Download** folder. **Command-Click** the **WebComponents.pkg** and then click **Open**. (If you are install the plug-in from the CD, just browse to **/Mac** folder and double click the **WebComponents.pkg** file.)

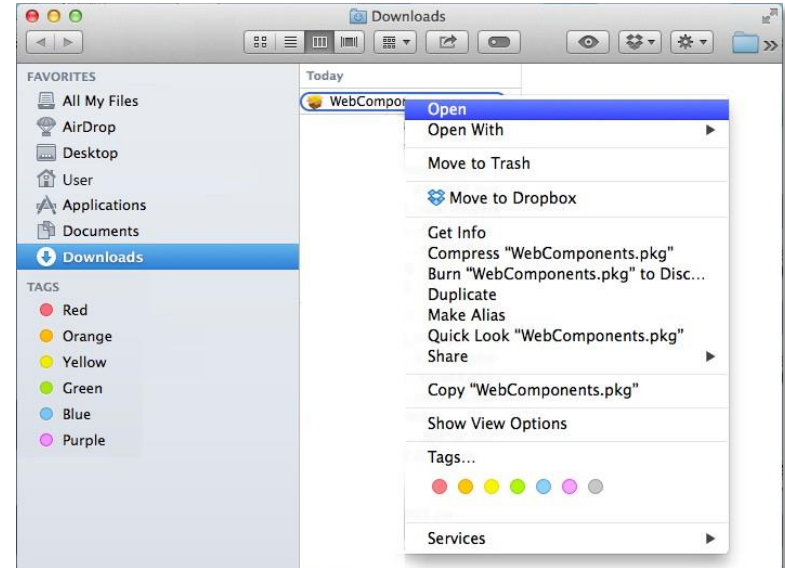

6. Click **Open** to start installation.



7. Click **Continue** to install the plug-in.



8. Select a destination to install the plug-in. Then click **Continue**.



9. Use the default location and click **Install**.

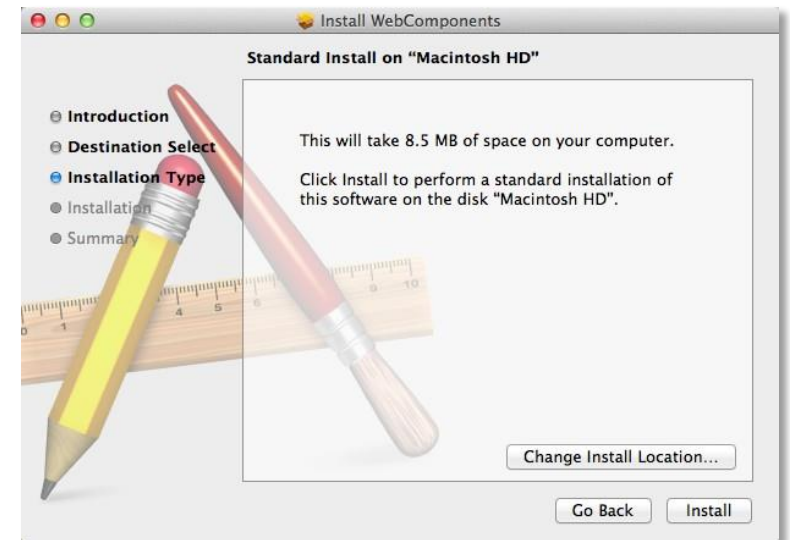

10. Enter your password and click **Install Software**

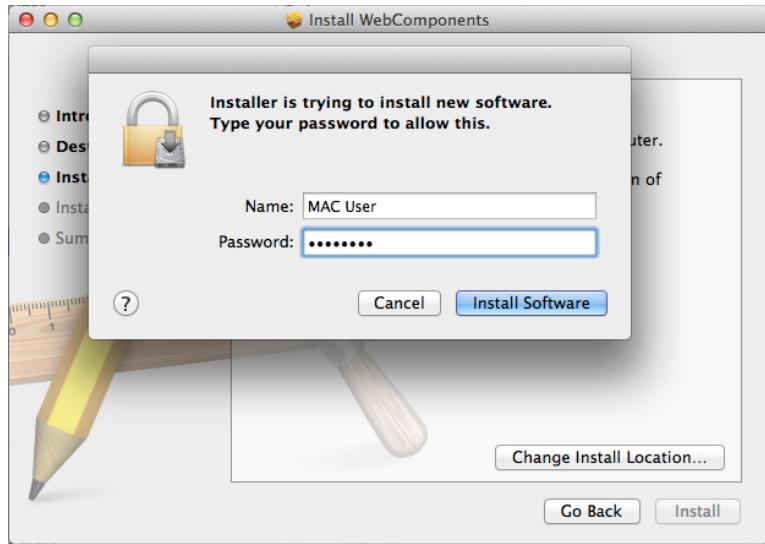

11. Installation will process automatically.

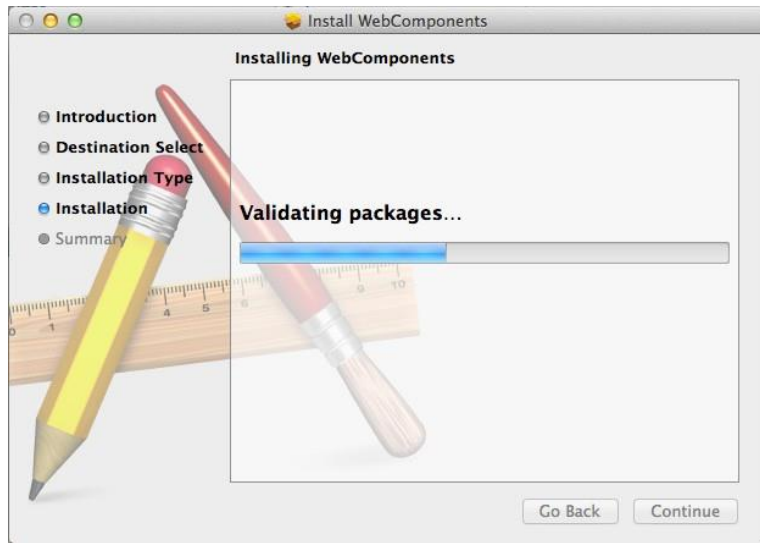

12. Click **Close** to exit the installation.

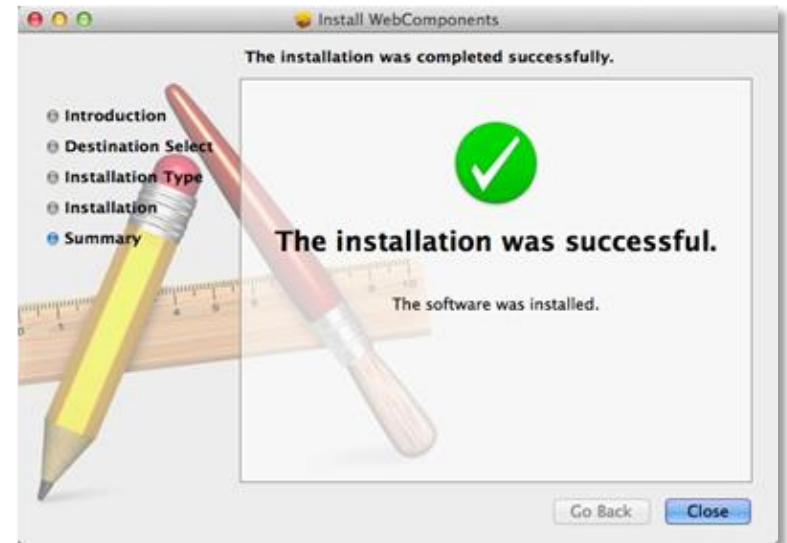

13. Open the browser and login again with the default IP 192.168.10.30 or the IP that was dynamically assigned by your router.

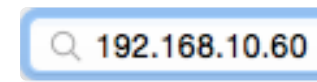

14. Enter the user name, **admin**, and the default password, **admin**, and then click **OK**.

To view this page, you must log in to area "TV-NVR104" on 192.168.10.60:80.
Your login information will be sent securely.

Name:

Password:

Remember this password in my keychain

Cancel Log In

15. Click **Trust** (You'll have to do this again when your camera changes to a new IP address.)

Do you want to trust the website "192.168.10.60" to use the "WebVideoPlugin" plug-in?

You can manage which websites you trust to use this plug-in in the Security pane of Safari preferences.

? Trust Cancel

16. The TV-NVR104 will ask you to change your password from the default setting. Please enter the new password twice and click **OK**. The password must be between 8 and 16 characters. (Alphanumeric: a-z, A-Z, 0-9, !, @, #, \$).

PLEASE ENTER YOUR NEW ADMINISTRATOR PASSWORD

User Name	admin
Password
Confirm

OK

17. Enter the user name **admin** and new password again to start secured session.

To view this page, you must log in to area "TV-NVR104" on 192.168.10.60:80.
Your login information will be sent securely.

Name:

Password:

Remember this password in my keychain

Cancel Log In

18. The **Live View** page shows up and the video starts to stream.

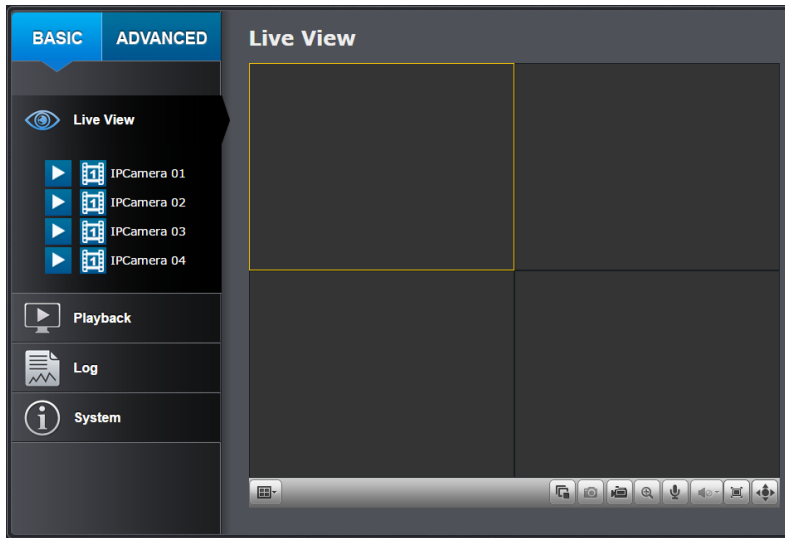







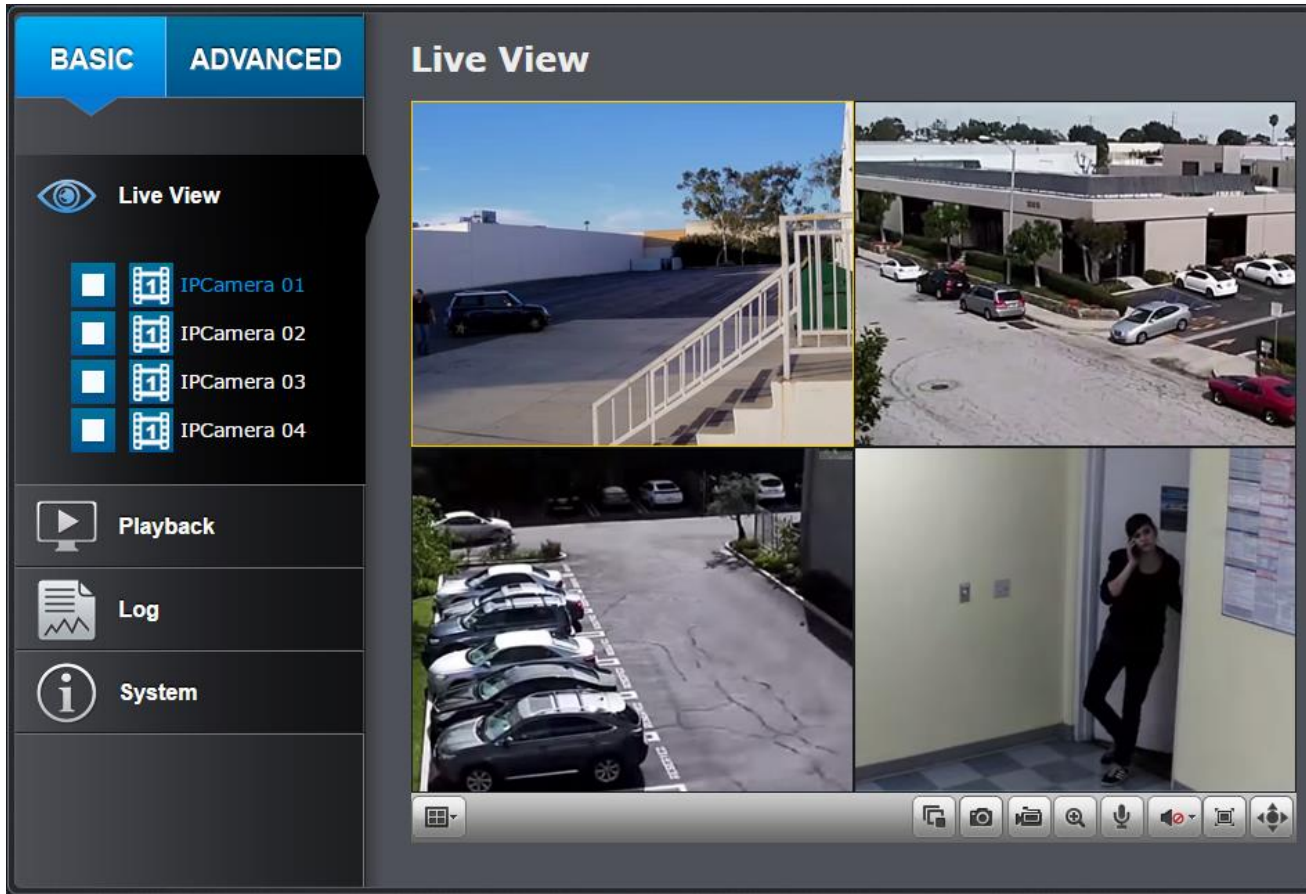

*Note: If you were not go through the basic setup, the camera plug-and-play process will begin after you setup the password. Wait a few minutes and press **command-R** to refresh the browser for the live video.*

Live View

After you log-in into the camera management page, you'll see the Live View page.



-  Start/Stop Streaming
-  Video Stream
-  Display Mode
-  Start/Stop All Streams
-  Snapshot
-  Start/Stop Recording
-  Zoom
-  Microphone
-  Speaker
-  PTZ Control

Start/Stop Streaming

Click this button to start or stop streaming. Select the display cell by click on it, (The yellow frame will wrap around the selected display cell.) then click on the icon of the stream you want. If the channel has been selected by others, stop that streaming before you change.

Video Stream

Click this button to choose the video stream between main stream and sub stream. 1: main stream; 2: sub stream.

Display Mode

Click this button to select the display mode to display a single video on the screen or display four videos on the screen at the same time.

Start/Stop All Streams

Click this button to start or stop all video streams.

Snapshot

Select the video you want to take a snapshot and then click this icon to take a video snapshot.

Start/Stop Recording

Select the video you want to record and then click this icon to start or stop video recording.

Zoom

Select single video display and then click once to enable zoom. When enabled, click and drag the area on the picture to zoom in. Right click to resume 100% zoom. Click the icon again to disable zoom. The zoom function works in full screen mode as well.

Microphone

Select the video channel and then click on this button to start/stop talking through the camera.

Speaker

Select the video channel and then click on this button to start/stop listening from the camera. Use the slide below to adjust the volume.

PTZ Control

Click this button to bring up the PTZ user interface.

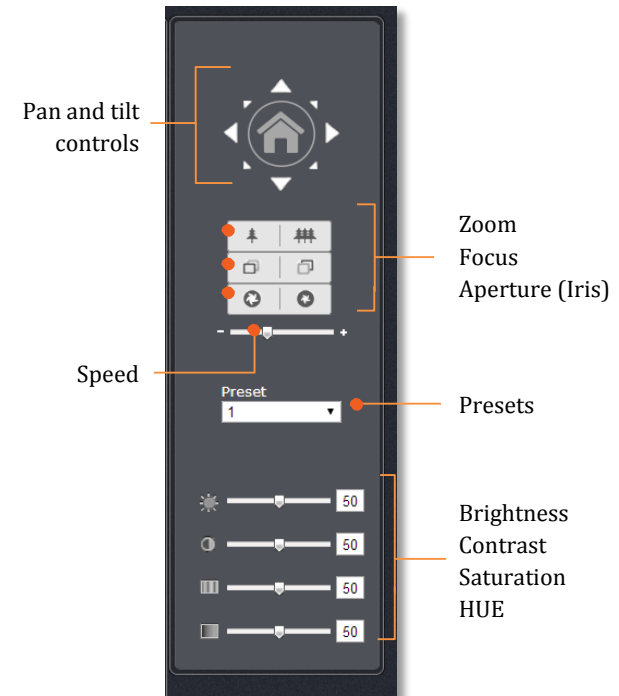

Where can I find saved files?

Videos and snapshots captured from **Live View** will be saved to your computer. See **Live View Settings** on page 104 for more details.

Playback

You can playback the video recording one at a time at this page. You can also download the video clip and snapshots to your local computer. Select the video channel on the left hand side and then search for the video.

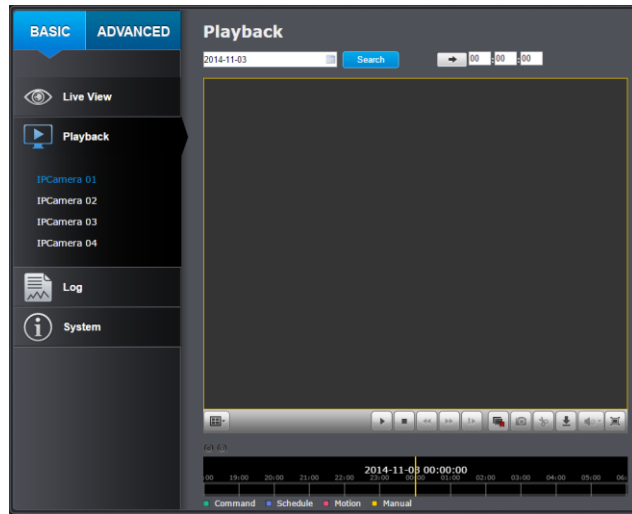

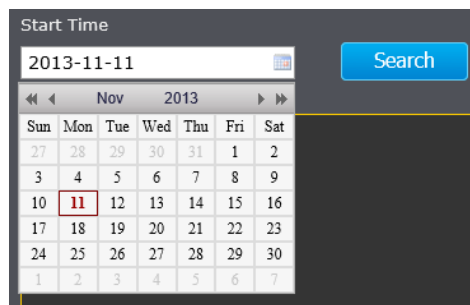

Search for video recordings

Click the date selection, and then choose a date as the date range of searching. Click **Search** to start searching.



Time Line

There is a play back head in the center of the time line represented in a yellow vertical line. To look for a specific video recording, move the time line by clicking and dragging it. If the recording is short, zoom in by clicking  button. Click  to zoom out the time scale. If you know the exact time of the day you are looking for, click  then enter the time you want to playback.

Different types of recordings are identified differently. The scheduled recordings are marked in blue, and the recordings triggered by motion detection are marked in red.

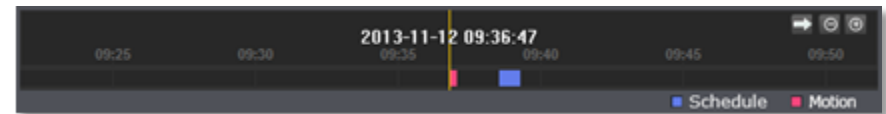

Click and drag the time line to move your time manually.



Click this button to zoom in the scale



Click this button to zoom out of the scale



Click this button to specify a specific time of the day.

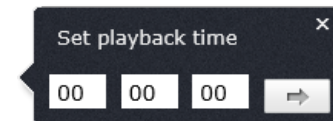







and then click  to confirm selection and then click X to close this dialog box.

Play video

Use playback controls to play back the video recording.









-  Click this button to play the video.
-  Click this button to pause video playback.
-  Click this button to stop playback.
-  Click this button increase playback speed*.
-  Click this button decrease playback speed*.
-  Click to playback video frame by frame. Click again for the next frame↓

* Note: There are 5 steps of playback speed you can choose from: 1/4, 1/2, 1, 2, and 4 times of original speed.

Slice images from video playback

You can take snapshots from playback video or make new video clips from the video you are playing back.



-  Click this button to stop video playback streams.
-  Click this button to take a snapshot of current playback.
-  Click this button to start clipping a video from playback.
-  Click this button or anywhere on the timeline to stop clipping a video from playback.
-  Click this button to download the files.
-  Click this button to enable or disable the audio playback.
-  Click this button for full screen playback.

Download recorded videos

To save complete video sections, you can download the files directly.



Click  button to download files.

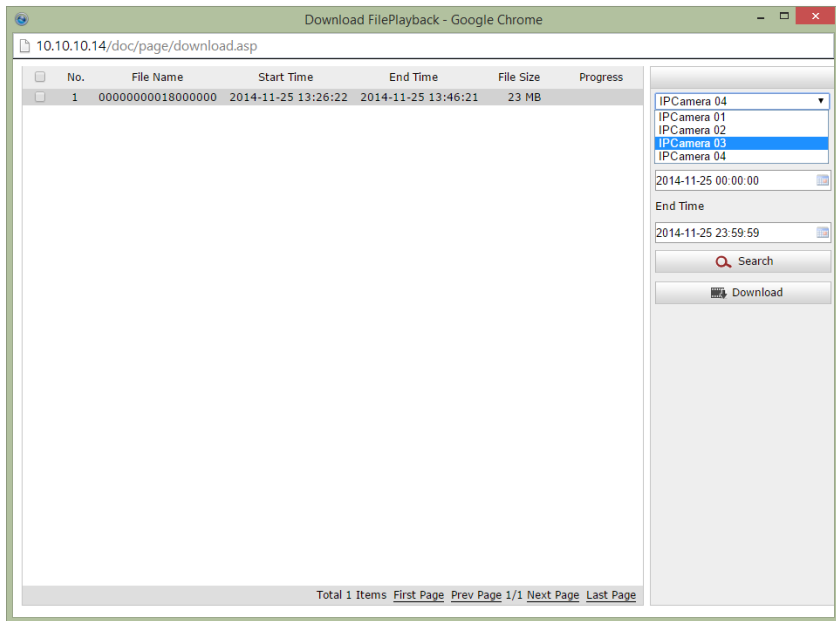

Check the time of the recording, select the videos you want to download, and then click **Download**.

Where can I find saved files?

Videos and snapshots captured from Playback will be saved to your computer. See **Live View Settings** on page 104 for details.

Log

The log of the TV-NVR104 is saving on the hard disk drive. You can search the relevant records and save to your local computer.

The screenshot shows the 'Search Log' interface. On the left, there is a sidebar with 'BASIC' and 'ADVANCED' tabs. Below the tabs are icons for 'Live View', 'Playback', 'Log', and 'System'. The main content area is titled 'Search Log' and includes a note: 'Log works only if the NAS is available'. There are two dropdown menus for 'Major Type' and 'Minor Type', both set to 'All Types'. There are 'Search' and 'Save Log' buttons. Below these are 'Start Time' and 'End Time' fields, both set to '2013-10-29 00:00:00' and '2013-10-29 23:59:59' respectively. A calendar is displayed for October 2013, with the 28th and 29th highlighted. Below the calendar is a 'Time' field set to '0 : 0 : 0' and 'Today' and 'OK' buttons. At the bottom of the interface, there is a status bar that reads 'Total 0 Items First Page Prev Page 0/0 Next Page Last Page'.

Search for logs

Click the type of log and then the Start Time and End Time. Click **Search** to start searching.

Total 129 Items [First Page](#) [Prev Page 1/2](#) [Next Page](#) [Last Page](#)

Click **First Page**, **Prev Page**, **Next Page**, and **Last Page** to show the logs. Click **Save Log** to save the logs to your computer.

Where can I find saved files?

Videos and snapshots captured from Playback will be saved to your computer. See **Live View Settings** on page 104 for details.

System Information

System Information page shows the TV-NVR104's basic information. Click **System** then click **System Info** to show the page.

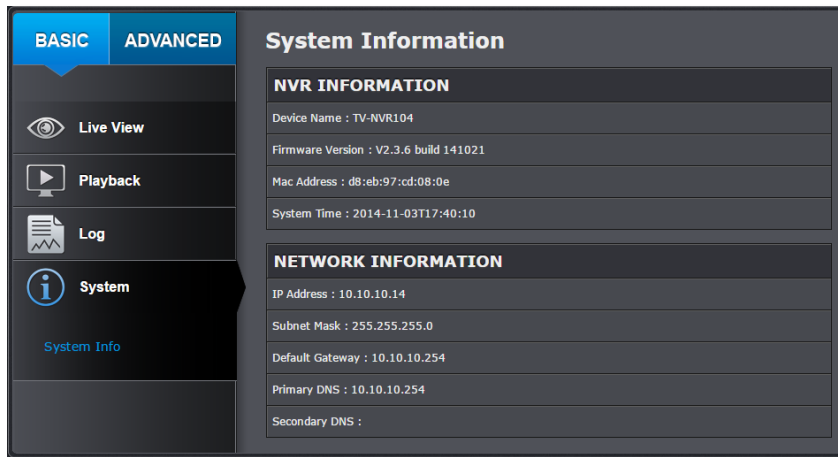

Basic Information

Device Name: Human readable device name for easy identification.

Firmware Version: Firmware version

MAC Address: The MAC address of Ethernet Interface

System Time: The system time setup in the camera. Keeping this time correct is important for recording, scheduled control and logging accurately.

Network Information

IP Address: IP address of the TV-NVR104

Subnet Mask: Network range of IP address

Default Gateway: The default route going from the TV-NVR104 subnet.

Primary DNS: Primary DNS server address

Secondary DNS: Secondary DNS server address

System Configuration

Device Settings

Setup your system name for easy identification. This device name will also be recognized by other network camera software as the name of this camera. OSD, On Screen Display, camera name is referring to this setting as well.

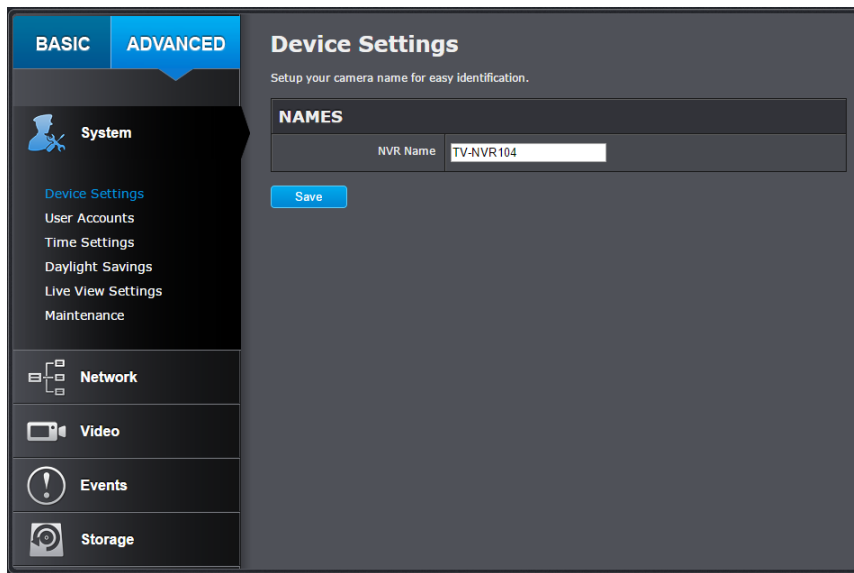

Enter the customized device name and then click on **Save** to save the settings.

User Accounts

You can setup up to 16 user accounts to access the NVR's video stream with a web browser or real time video stream (RTSP). Only one administrator account can be setup to configure the TV-NVR104 and cannot be deleted.

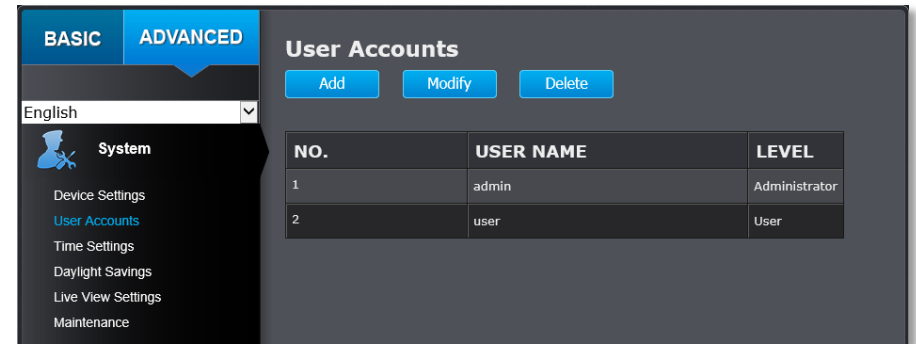

User Accounts

Add: Click **Add** button to add one user account

Modify: To change a user's name and password, highlight the user by clicking on it. Then, click **Modify** button. You can change the user's name and password. You can also change the administrator's password here. But, the administrator's name is fixed, you cannot change that.

Click **OK** to save the changes.

Time Settings

The accuracy of the system clock is important for scheduling and accurate logging. You can synchronize the system time with your computer, or automatically check the time accuracy with a network time server (NTP server).

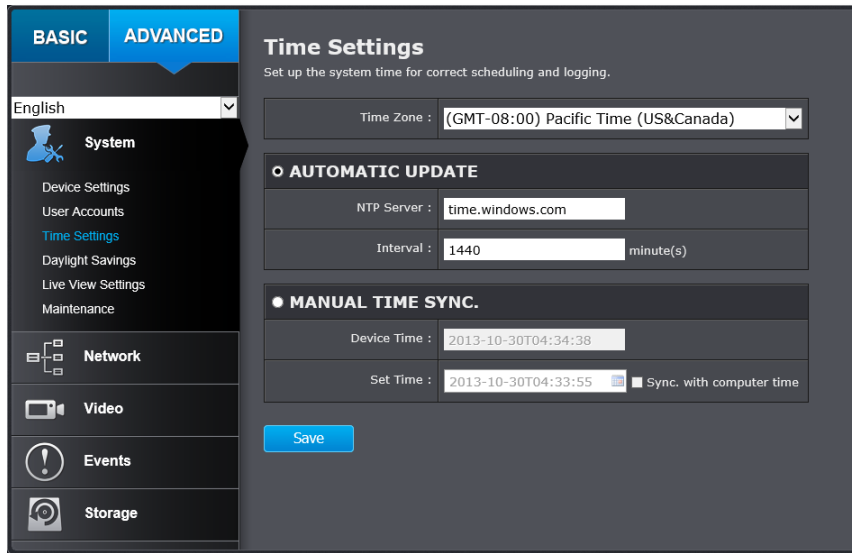

Automatic Update

NTP Server: Specify a time server (NTP server) to synchronize with. (e.g. pool.ntp.org)

Interval: The time interval that the TV-NVR104 will synchronize the time with NTP server. Default: 1440 minutes (24 hours)

Click **Save** to save the changes

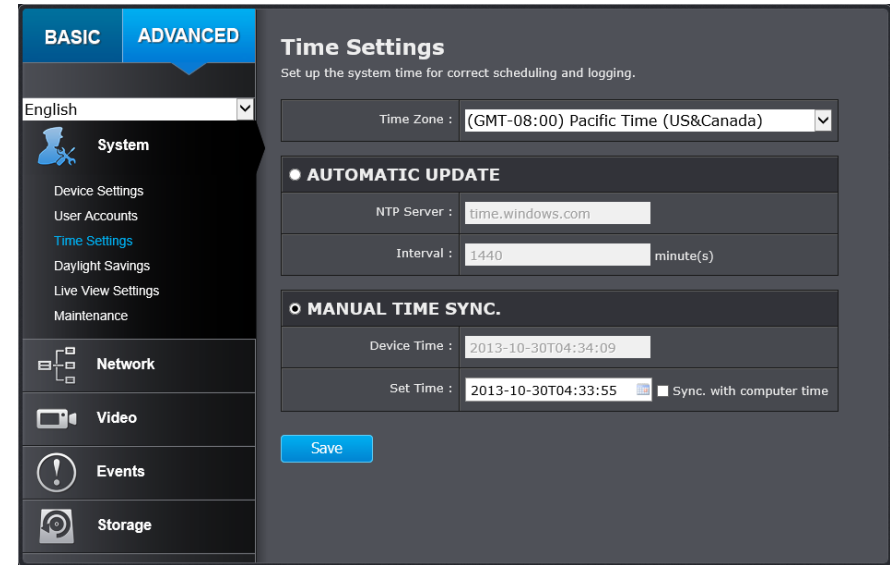

Manual Time Sync

Device Time: The system time of this camera.

Set Time: Click the calendar icon and manually select the date. Check the **Sync. with computer time** to copy the time from your computer.

Click **Save** to save the changes

Daylight Savings

Setup daylight savings.

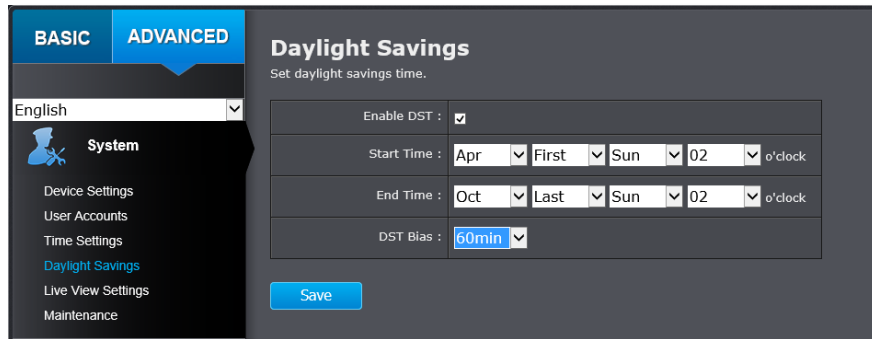

The screenshot shows the 'Daylight Savings' configuration page in the Trendnet web interface. The page is divided into 'BASIC' and 'ADVANCED' tabs, with 'ADVANCED' selected. The left sidebar contains a 'System' menu with options: Device Settings, User Accounts, Time Settings, Daylight Savings (highlighted), Live View Settings, and Maintenance. The main content area is titled 'Daylight Savings' and includes the instruction 'Set daylight savings time.' Below this, there are four rows of configuration options: 'Enable DST' with a checked checkbox; 'Start Time' with dropdowns for 'Apr', 'First', 'Sun', and '02' o'clock; 'End Time' with dropdowns for 'Oct', 'Last', 'Sun', and '02' o'clock; and 'DST Bias' with a dropdown set to '60min'. A blue 'Save' button is located at the bottom of the configuration area.

Automatic Update

Enable DST: Check this box if your time zone has daylight savings.

Start Time: Enter the date that daylight savings starts

End Time: Enter the date that daylight savings ends

DST Bias Enter how much time the daylight saving adjusted by daylight savings.

*Click **Save** to save the changes*

Live View Settings

Setup the live view video quality, file size and file saving directories.

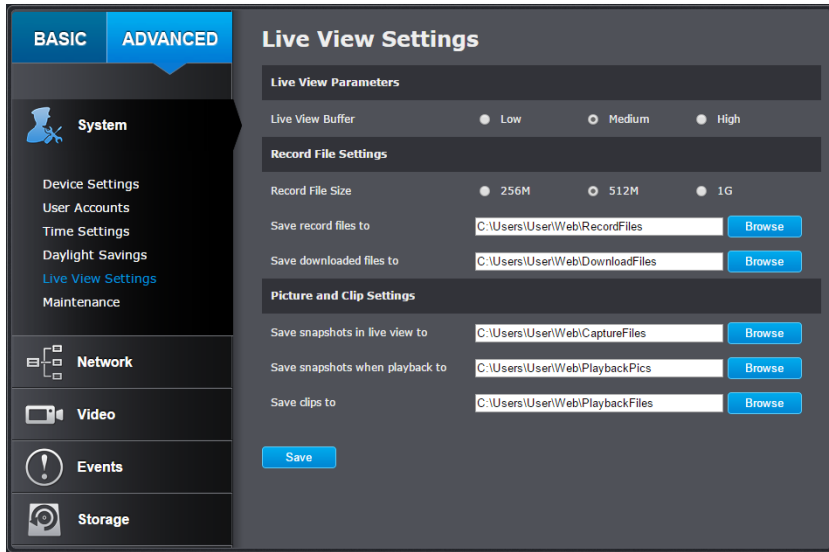

Live View Parameters

Live View Buffer: Configure the buffer size for live view video stream. With low buffer size setting, you can get real-time video stream, but the video may be stop and go if the network is congested. With high buffer setting, you can have smooth video streaming, but the video is delayed from the time happening. Medium size can have moderate video stream smoothness and time delay.

Record File Settings

Record file size: This size of live view video recording. You can choose 256MB, 512MB, or 1GB a file. Smaller file size is good for many short recordings.

Save record files to: By default, files will be saved under the folder with your user name, under the subdirectory TRENDnet/RecordFiles. Click **Browse** and then choose a new destination if you want to save the file somewhere else.

Save downloaded files to: By default, files will be saved under the folder with your user name, under the subdirectory TRENDnet/DownloadFiles. Click **Browse** and then choose a new destination if you want to save the file somewhere else.

Picture and Clip Settings

Save snapshots in live view to: By default, files will be saved under the folder with your user name, under the subdirectory TRENDnet/SnapshotFiles. Click **Browse** and then choose a new destination if you want to save the file somewhere else.

Save snapshots when playback to: By default, files will be saved under the folder with your user name, under the subdirectory TRENDnet/PlaybackPics. Click **Browse** and then choose a new destination if you want to save the file somewhere else.

Save clips to: By default, files will be saved under the folder with your user name, under the subdirectory TRENDnet/PlaybackFiles. Click **Browse** and then choose a new destination if you want to save the file somewhere else.

*Click **Save** to save the changes*

Maintenance

You can restart, load camera settings and upgrade the camera firmware on this page.

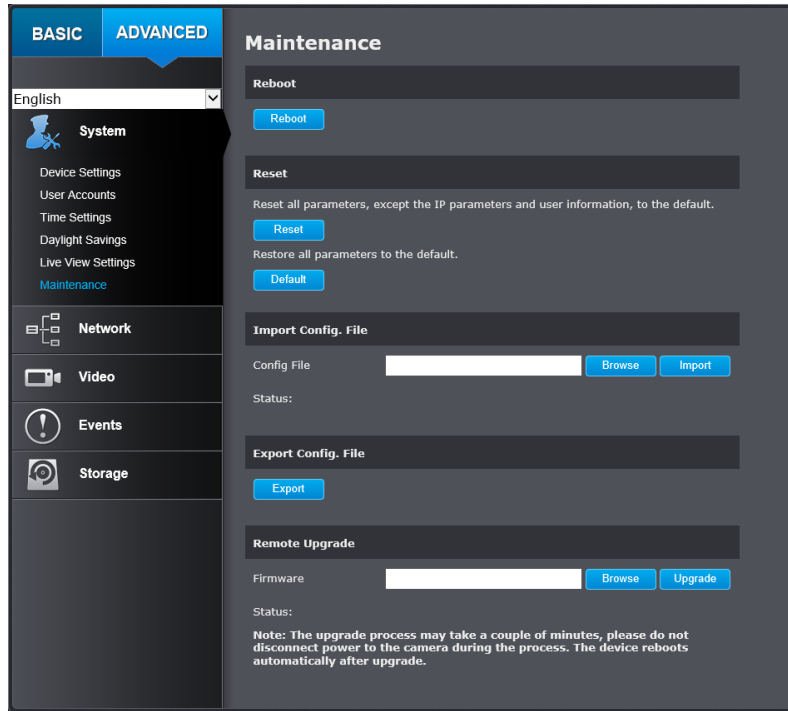

Reboot

Reboot: Click this button to reboot this camera.

Reset

Reset: Reset all camera parameters, except the IP parameters and user information.

Default: Load complete factory default to the camera.

Import Config. File

Config File: To load previously saved settings, click **Browse** to find the configuration file and then click **Import**.

Status: Shows the status in loading configuration file.

Export Config. File

Export: Click Export to download configuration file. The file will be downloaded to the Download folder by default.

Remote Upgrade

Firmware: Click Browse to find the latest firmware and then click Upgrade.

Status: Shows the status in firmware upgrade.

TRENDnet may periodically release firmware upgrades that might add features or fix problems associated with your TRENDnet model and version. To find out if there is a firmware upgrade available for your device, please check your TRENDnet model and version using the link.

<http://www.trendnet.com/downloads/>

1. If a firmware upgrade is available, download the firmware to your computer.
2. Unzip the file to a folder on your computer.
3. Read the firmware upgrade instruction for specific version update information.
4. Log into the TV-NVR104.
5. Getting to this Maintenance page to upgrade firmware.

Network Settings

TCP/IP

Setup your basic IPv4 and IPv6 network settings on this page.

Network Interface

Duplex and Speed: Choose one of the Ethernet duplex and speed to match your network. Default: auto.

MAC Address: Click this button to reboot this camera.

MTU: Maximum transmission unit. The maximum field size in the Ethernet packet.

Primary DNS: Enter your first IPv4 or IPv6 DNS server address

Secondary DNS: Enter your second IPv4 or IPv6 DNS server address

IPv4

DHCP: Check this box if the IP address is assigned by DHCP server.

IPv4 Address: The IPv4 dynamic or static address

Subnet Mask: Network range of the subnet

Default Gateway: The default route going further from TV-IP320PI IPv4 subnet

IPv6

IPv6 Address: IPv6 self-assigned address of TV-NVR104

IPv6 Default Gateway: The default route going further from TV-NVR104 IPv6 subnet

Port

You can change the service port numbers of TV-NVR104 and enable/disable RTSP or HTTPS services.

Service Ports
Enable/ disable service ports. Change service port numbers.

PORT NUMBERS	
HTTP Port :	80
RTSP Port :	<input type="checkbox"/> 554

[Save](#)

DDNS

Dynamic Domain Name Service, DDNS, allows you to find your camera from the Internet with an easy to remember domain name.

Dynamic Domain Name Service (DDNS)
Easier locate your camera by setting up dynamic domain name service.

Enable DDNS :

DDNS Type : dyn.com

Server Address :

Domain :

User Name :

Password :

Confirm :

[Save](#)

Port Numbers

HTTP Port: The default web access port. You can change the port number. However, you cannot disable the web service. The default port number is 80.

RTSP Port: The Real-Time Streaming Protocol port for video streaming. You can change the port number or disable the service by uncheck the box. The default port number is 554.

Click **Save** to save the changes

DDNS

Enable DDNS: Check this box to enable DDNS Service.

DDNS Type: Select a DDNS service provider.

Server Address: Enter the DDNS server address.

Domain: Enter your registered domain/host name on selected DDNS service.

User Name: Enter the account name.

Password: Enter the password.

Confirm: Enter the password again.

Click **Save** to save the changes

Video Settings

Video Format

Adjust the settings of video streams.

Setting	Value
Channel	IPCamera 01
Stream Type	Main Stream(Normal)
Video Encoding	H.264
Resolution	1280*720P
Bitrate Type	Variable
Video Type	Video Stream
Video Quality	Medium
Frame Rate	30 frames per second
Max. Bitrate	2048 kbps

Channel: Select which video stream for video format changes.

Stream Type: Choose the main stream or sub stream of the video channel to change its video formats.

Video Encoding: Choose the video encoding type. H.264 is more advanced selection while MJPEG videos is compatible to more applications such as embedded web video.

H.264
MJPEG

Resolution: Resolution of the video stream.

Bitrate Type: Choose between variable bit rate and constant bit rate for video compression. The default is variable rate.

Video Quality: Choose the video quality. The default is medium quality.

Frame Rate: Choose the capturing frame rate. Reduce the frame rate to reduce the capture file size.

Max. Bitrate: Choose the maximum video sampling bit rate.

*Click **Save** to save the changes*

On Screen Display Settings

Display the camera name and the time the video. Select the video channel you want to change the setting, then change the settings. Move the red box to position the text. Click on **Save** to save the changes.

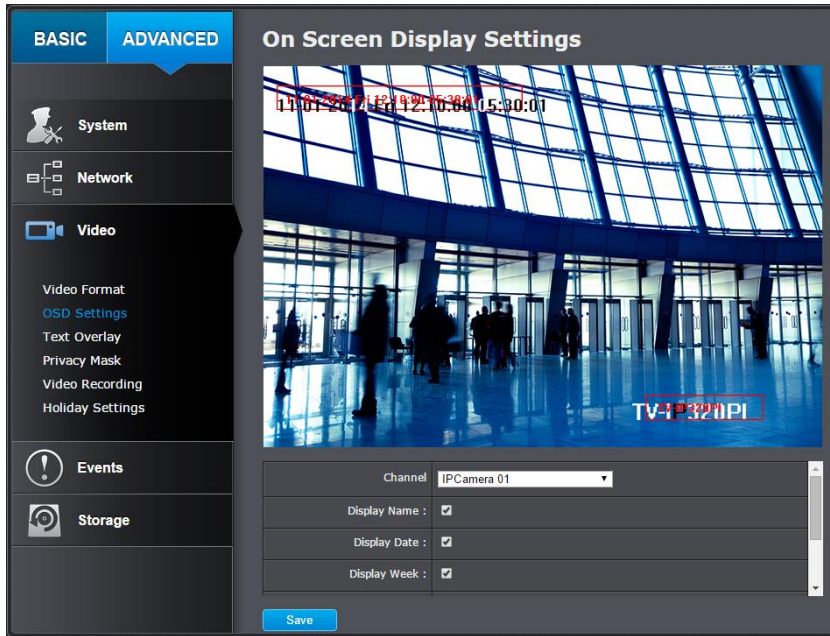

- Channel:** Select the video channel you want to edit.
- Display Name:** Check this box to display the product name that was setup in the device settings.
- Display Date:** Check this box to display system time.
- Display Week:** Check this box to display time of the week.
- Time Format:** Select 12 or 24-hour time format.
- Date Format:** Select the date format
- Display Mode:** Choose how the text will show on the screen.

Text Overlay

Display extra information on the screen over the image. Move the red box to position the text. Click on **Save** to save the changes.

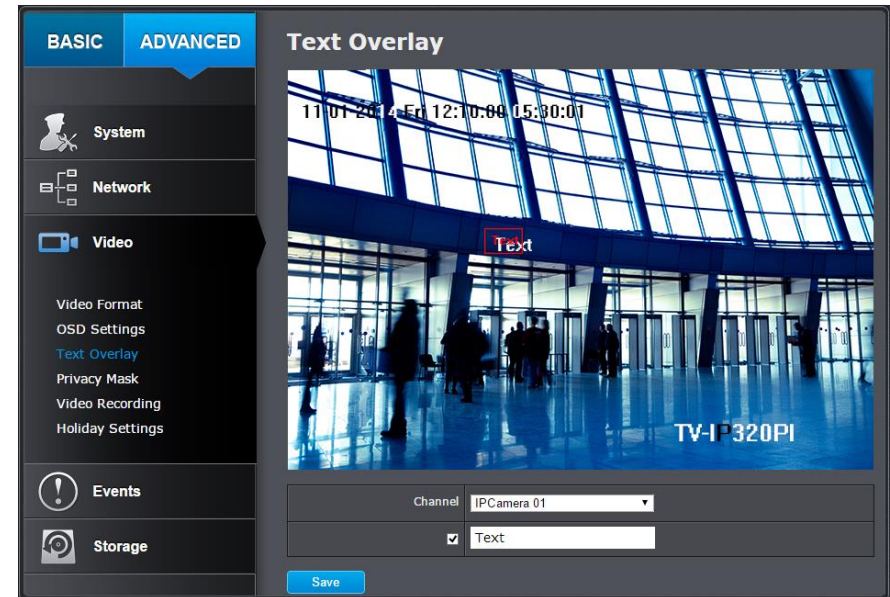

- Channel:** Select the video channel you want to edit.
- Check Box:** Check this box to enable text overlay.
- Text Field:** Enter the text you want to display. The length of the text is decided by limitation of the camera.

Privacy Mask

Create a masking area to keep your privacy. You can create up to four independent masking areas by clicking and dragging on the screen.

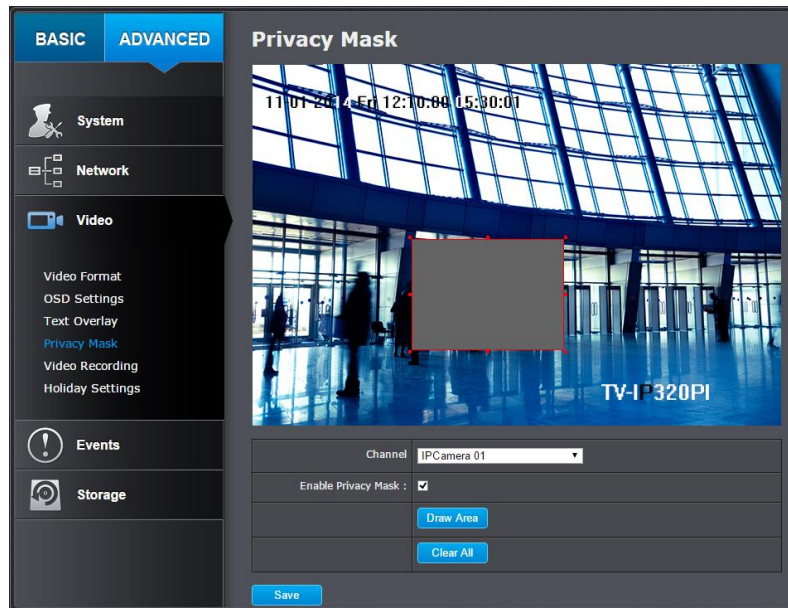

- Channel:** Select the video channel you want to edit.
- Enable Privacy Mask:** Check this box to enable privacy masking.
- Stop Drawing:** Click this button to stop drawing.
- Clear All:** Click this button to clear all the masking areas.

Click **Save** to save the changes

Video Recording

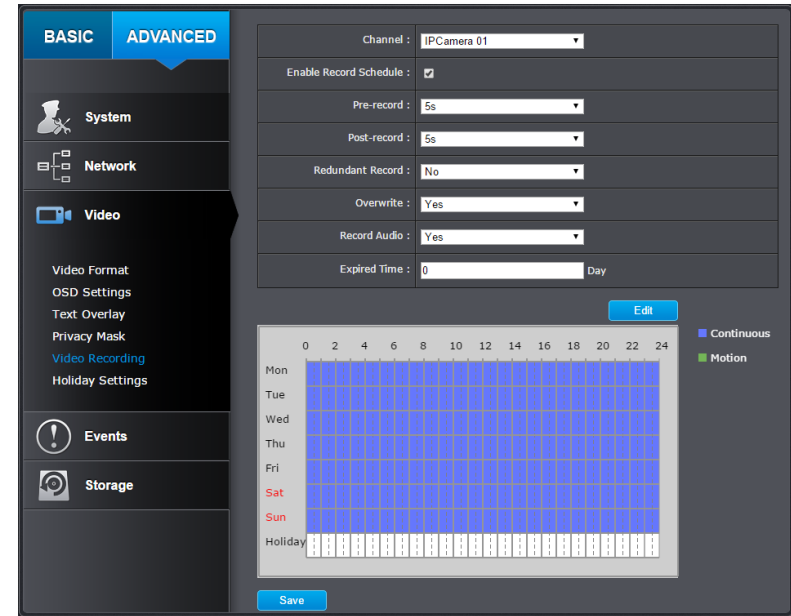

- Channel:** Select the video channel you want to edit.
- Enable Record Schedule:** Check this box and then click **Save** to enable video recording.
- Schedule:**

Pre-record: Recording time before trigger event.

Post-record: Recording time after trigger event.

Overwrite: Select Yes to allow older recordings to be overwritten.

Record Audio: Record audio when the camera has audio capability.

Expire Time: Specify how many days you want to lock the recording.

Click **Save** to save the changes

Edit: Click **Edit** to edit the recording schedule. The Edit Schedule window will pop up.

Edit Schedule

Mon Tue Wed Thu Fri Sat Sun

All Day

Customize

Period	Start Time	End Time	Record Type
1	00:00	00:00	Continuous
2	00:00	00:00	Continuous
3	00:00	00:00	Continuous
4	00:00	00:00	Continuous
5	00:00	00:00	Continuous
6	00:00	00:00	Continuous
7	00:00	00:00	Continuous
8	00:00	00:00	Continuous

Copy to Week Select All

Mon Tue Wed Thu Fri Sat Sun

1. Select day of the week you want to edit.
2. Select **All Day** or **Customized** schedule of the day.
3. Set the time period and the event you want to trigger the video recording **continuous** (always recording) or **motion detection**.
4. Click **Select All** or the weekday you want to have the same schedule on different day.
5. Click another day of the week by clicking on its tab to set the next schedule. Click **OK** when you have finished your settings.

Holiday Settings

Recording video in holidays may have different requirements. You can set up to 11 holidays of a year sharing the same holiday profile.

Set up the holiday schedule by clicking on button.

BASIC **ADVANCED**

Holiday Settings

The periods of holiday cannot be overlapped.

No.	Holiday Name	Status	Start Date	End Date	Edit
1	Holiday1	Enable	1.Jan	1.Jan	
2	Holiday2	Disable	1.Jan	1.Jan	
3	Holiday3	Disable	1.Jan	1.Jan	
4	Holiday4	Disable	1.Jan	1.Jan	
5	Holiday5	Disable	1.Jan	1.Jan	
6	Holiday6	Disable	1.Jan	1.Jan	
7	Holiday7	Disable	1.Jan	1.Jan	
8	Holiday8	Disable	1.Jan	1.Jan	
9	Holiday9	Disable	1.Jan	1.Jan	
10	Holiday10	Disable	1.Jan	1.Jan	
11	Holiday11	Disable	1.Jan	1.Jan	
12	Holiday12	Disable	1.Jan	1.Jan	
13	Holiday13	Disable	1.Jan	1.Jan	
14	Holiday14	Disable	1.Jan	1.Jan	
15	Holiday15	Disable	1.Jan	1.Jan	
16	Holiday16	Disable	1.Jan	1.Jan	

System

Network

Video

Video Format

OSD Settings

Text Overlay

Privacy Mask

Video Recording

Holiday Settings

Events

Storage

Edit Holiday

Holiday Name:

Enable Holiday:

Type:

Start Date:

End Date:

Edit Holiday Schedule

Holiday Name: Change the holiday name to meaningful name instead of index numbers.

Enable: Enable or disable this holiday rule.

Type: Select the holiday is for a day, a week or a month.

Day mode: Select the start and end dates to specify the period of holidays. This setting is good for one time only. It does not repeat periodically.

Week mode: Select the start and end dates of the week to specify the period of holidays. This setting is repeating every year.

Month mode: Select the start and end dates to specify the period of holidays. This setting is repeating every year.

Start Date: Select the day when the holiday starts.

End Date: Select the day when the holiday ends.

Click **OK** to save the changes

Events

Motion Detection

Set up how the motion detection event will be triggered and what actions will be triggered.

Note: This feature is camera dependent.

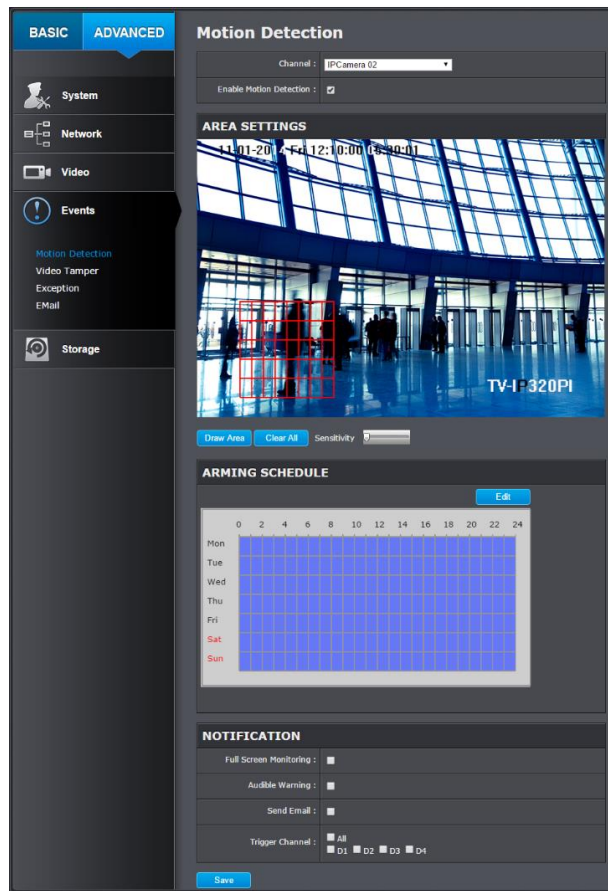

- Channel:** Select the video channel you want to edit.
- Enable Motion Detection:** Check this box to enable motion detection. Click **Save** to save the choice.
- Draw Area:** Click **Draw Area** button to start drawing. Click and drag on the area you want to set up the motion detection. The number of areas you can set up depends on camera models. Click **Stop Drawing** to stop drawing motion detection areas. The red grids represent the motion detection area.



- Sensitivity:** Move the slider to adjust detection sensitivity.
- Clear All:** Click this button to clear all the set up areas.

Arming Schedule

Edit: Click **Edit** to edit the recording schedule. The Edit Schedule window will pop up.

Edit Schedule

Mon | Tue | Wed | Thu | Fri | Sat | Sun

All Day Continuous

Customize

Period	Start Time	End Time	Record Type
1	00:00	00:00	Continuous
2	00:00	00:00	Continuous
3	00:00	00:00	Continuous
4	00:00	00:00	Continuous
5	00:00	00:00	Continuous
6	00:00	00:00	Continuous
7	00:00	00:00	Continuous
8	00:00	00:00	Continuous

Copy to Week Select All

Mon Tue Wed Thu Fri Sat Sun Copy

OK Cancel

3. Select day of the week you want to edit.
4. Select **All Day** or **Customized** schedule of the day.
5. Set the time period and the event you want to trigger the video recording **continuous** (always recording) or **motion detection**.
6. Click **Select All** or the weekday you want to have the same schedule on different day.
7. Click another day of the week by clicking on its tab to set the next schedule. Click **OK** when you have finished your settings.

Notification

Full Screen Monitoring: Switch the video on the VGA/HDMI monitor to the camera detected motion event.

Audible Warning: Activate the audible on board buzzer.

Send Email: Send email to notify the system manager.

Trigger channel: Use this motion event as the trigger to invoke actions in other channels.

*Click **Save** to save the changes*

Video Tampering

Set up how the video tampering detection event will be triggered and what actions will be triggered. When video is suddenly blocked or blackened, tampered, the video tamper notifications will alert the system manager to check the camera.

Note: This feature is camera dependent.

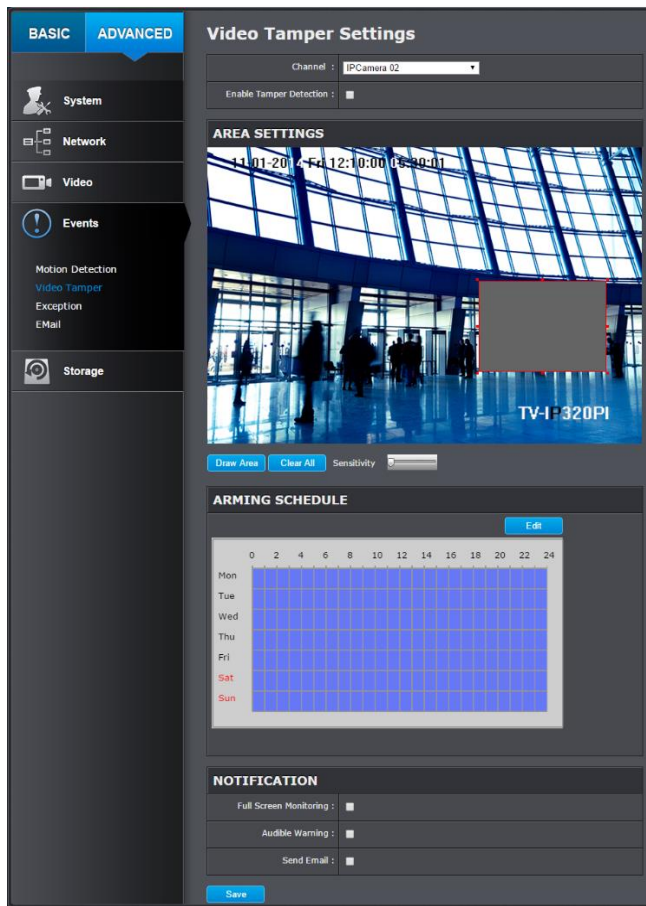

Channel: Select the video channel you want to edit.

Enable Tamper Detection: Check this box to enable tamper detection. Click **Save** to save the settings.

Draw Area: Click **Draw Area** button to start drawing. Click and drag on the area you want to set up the tamper detection. Click **Stop Drawing** to stop drawing motion detection areas. The gray block represents the detection area.



Sensitivity: Move the slider to adjust detection sensitivity.

Clear All: Click this button to clear all the set up areas.

Arming Schedule

Edit: Click **Edit** to edit the recording schedule. The Edit Schedule window will pop up.

Edit Schedule

Mon Tue Wed Thu Fri Sat Sun

All Day

Customize

Period	Start Time	End Time	Record Type
1	00:00	00:00	Continuous
2	00:00	00:00	Continuous
3	00:00	00:00	Continuous
4	00:00	00:00	Continuous
5	00:00	00:00	Continuous
6	00:00	00:00	Continuous
7	00:00	00:00	Continuous
8	00:00	00:00	Continuous

Copy to Week Select All

Mon Tue Wed Thu Fri Sat Sun

1. Select day of the week you want to edit.
2. Select **All Day** or **Customized** schedule of the day.
3. Set the time period and the event you want to trigger the video recording **continuous** (always recording) or **motion detection**.
4. Click **Select All** or the weekday you want to have the same schedule on different day.
5. Click another day of the week by clicking on its tab to set the next schedule. Click **OK** when you have finished your settings.

Notification

Full Screen Monitoring: Switch the video on the VGA/HDMI monitor to the camera detected motion event.

Audible Warning: Activate the audible on board buzzer.

Warning:

Send Email: Send email to notify the system manager.

Click **Save** to save the changes

Exception

Provide notifications for other system events, set up your notifications here.

BASIC **ADVANCED**

System Notification

Exception Type : Storage Full

NOTIFICATION

Audible Warning :

Send Email :

System

Network

Video

Events

Motion Detection

Video Tamper

Exception

Email

Storage

Notification

Exception Type: First, choose the exception type, and then choose the corresponding action.

Storage Error

Storage Full

Storage Error

Network Disconnected

IP Address Conflicted

Illegal Login

Record Exception

Audible Warning: Activate the audible on board buzzer.

Send Email: Check this box to send an e-mail notification when motion is detected.

Click **Save** to save the changes

Email

Set up email accounts for notifications.

Sender

Sender: Enter the name to be appeared as the email sender.

Sender's Address: Enter sender's email address.

SMTP Server: Simple Mail Transportation Protocol Server address, the outgoing email server address. It may be has address as your incoming email server, maybe not. Please ask your email service provider for detail.

SMTP Port: Service port number for outgoing email.*

Authentication: Check this box if your server requires a password in order to send email. Most email servers require authentication when sending an email.

User name: Enter the user name of outgoing email account

Password: Enter the password

Confirm: Enter the password again to confirm that the password was entered correctly.

*Click **Save** to save the changes*

Receiver

Receiver 1: The first receiver's name.

Receiver 1's Address: The first receiver's email address.

Receiver 2: The second receiver's name.

Receiver 2's Address: The second receiver's email address.

Receiver 3: The third receiver's name.

Receiver 3's Address: The third receiver's email address.

*Click **Save** to save the changes*

**Note: Many ISPs does not allow service port 25 going through their network. Please consult your email service provider and ISP for detail. TV-NVR104 does not support SSL or TLS. Please select the right email service for the notifications.*

Storage

Storage Management

To setup and initiate the hard drive remotely, check the hard disk drive and then click on **Format**.

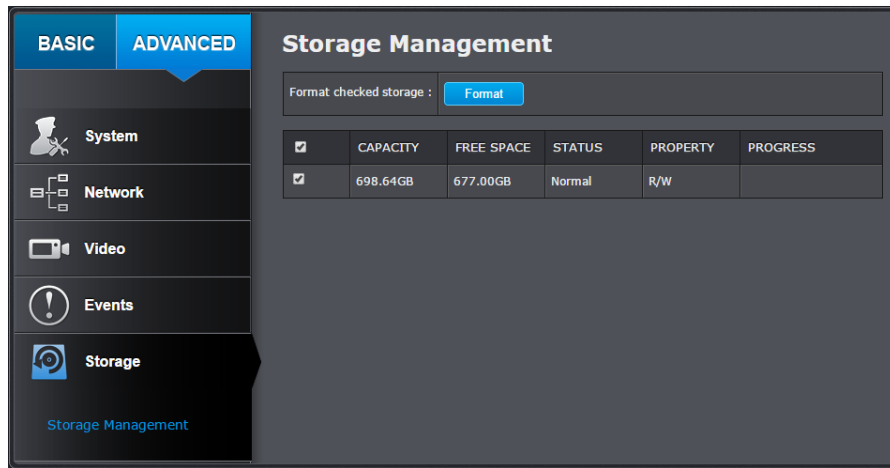

Format: Select the storage volume and then click **Format** to format your hard disk drive. This action will format the volume for video recording. Placeholder files (formatting files) will be created to make sure disk allocation is appropriate and the file searching is optimized.

Capacity: The total capacity of the hard disk can be used for video recording and log.

Free Space: The free space left for video recording and log.

Status: The disk status.

Property: This network storage is read only or can be read and write.

Appendix

Turn on network discovery on Windows

The TV-NVR104 is UPnP enabled device. Find your camera is easy with Windows network discovery. If your network discovery is turned off, go to **Control Panel >> Network and Internet >> Network and Sharing Center >> Advanced sharing settings** and then select **Turn on network discovery**. Click **Save** changes to save the changes. If you still have difficulty to find your camera with network discovery, check it out if it has to network discovery setting on other network profiles.

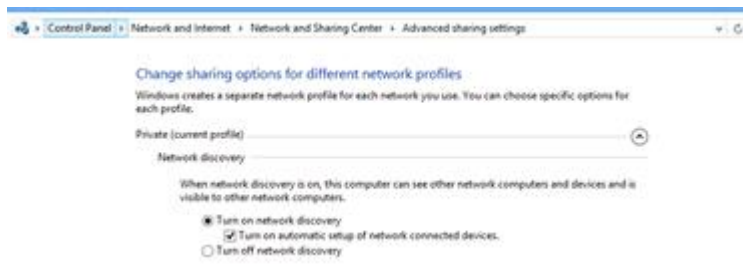

Direct video access - RTSP

To access the video directly through RTSP, just visit the camera IP address on port 554 by default.

To access the video through NVR, you need to enter the IP address, port number and leading path "/Streaming/Channels" then specify the channel number. The channel number is 2 digits leading with zero. For example: `rtsp://192.168.10.60:554/Streaming/Channels/01` to view the channel 1 video on TV-NVR104 which located on 192.168.10.60.

Install your NVR System on Your Network

To enable remote network access to the NVR, you need to install your NVR onto your network. Make sure your NVR system is working on the same network segment your router defined. Reserve a pool of IP addresses for NVR and all cameras. You can then access your NVR and network cameras everywhere over the network.

The other option to setup the NVR and cameras on your network is using DHCP. The TV-NVR104 DHCP client is default disabled. You can enable DHCP client manually.

1. Go page 48 General Network Settings to enable the TV-NVR104 getting its IP address from your router DHCP.
2. Reboot your TV-NVR104.
3. Reset your cameras if you connects them to the network before. (To reset the TV-IP320PI camera, you need to power off the camera. Then press and hold the reset button. And then power the camera on while keep holding the reset button. Keep holding the reset button for 10 seconds and let the camera restore all factory defaults. For other cameras, please reference to the camera's user guide.)
4. Plug in the PoE cameras to the PoE ports.
5. All the cameras are getting the assigned IP address from your router.
6. For plug-and-play cameras, such as TV-IP320PI, installed directly on the PoE port, the TV-NVR proceed following settings on camera to add on the security.
 - The camera will be assigned with an IP assigned by your router and then the address becomes static IP on the camera. You can write down the IP address for remote access or advanced port forwarding settings on your router. Please make the assigned IP reserved, so your router will not accidentally assign the same address to other of your network devices.

Hostname	MAC Address	IP Address	Enabled
			<input type="checkbox"/>
			<input type="checkbox"/>
			<input type="checkbox"/>
			<input type="checkbox"/>
			<input type="checkbox"/>
			<input type="checkbox"/>
			<input type="checkbox"/>
			<input type="checkbox"/>
			<input type="checkbox"/>
			<input type="checkbox"/>

- If the camera has its default setting, the password will be set to the same password you set to the TV-NVR104.
- You can visit the camera with the new preset password. (For more camera password management, please see Camera Connection Settings on page 29 for more details.)

Compatible Camera List

Most of TRENDnet and ONVIF cameras are compatible with TV-NVR104. For the best performance and interoperability, the following camera models are suggested:

Model	Protocol	Default Port	Description	Basic PTZ	Adv. PTZ	Audio
TV-IP310PI	TRENDnet3	8000	3MP Outdoor IR Bullet	NA	NA	NA
TV-IP311PI	TRENDnet3	8000	3MP Outdoor IR Dome	NA	NA	NA
TV-IP320PI	TRENDnet3	8000	1.3MP Outdoor IR Bullet	NA	NA	NA
TV-IP321PI	TRENDnet3	8000	1.3MP Outdoor IR Dome	NA	NA	NA
TV-IP342PI	ONVIF	80	2MP Outdoor IR Dome	NA	NA	Yes
TV-IP343PI	ONVIF	80	2MP Outdoor IR Bullet	NA	NA	Yes
TV-IP430P	TRENDnet3	8000	2MP Outdoor Speed Dome	Yes	Yes	Yes
TV-IP450P	TRENDnet3	8000	1.3MP Outdoor Speed Dome	Yes	Yes	Yes
TV-IP572P	TRENDnet1	80	720p Indoor Camera	NA	NA	Yes
TV-IP572PI	TRENDnet1	80	720p Indoor IR Camera	NA	NA	Yes
TV-IP672P	TRENDnet1	80	720p Indoor PTZ Camera	Yes	NA	Yes
TV-IP662PI	TRENDnet1	80	720p Indoor PTZ IR Camera	Yes	NA	Yes

Regulations

Federal Communication Commission Interference Statement

This equipment has been tested and found to comply with the limits for a Class B digital device, pursuant to Part 15 of the FCC Rules. These limits are designed to provide reasonable protection against harmful interference in a residential installation. This equipment generates uses and can radiate radio frequency energy and, if not installed and used in accordance with the instructions, may cause harmful interference to radio communications. However, there is no guarantee that interference will not occur in a particular installation. If this equipment does cause harmful interference to radio or television reception, which can be determined by turning the equipment off and on, the user is encouraged to try to correct the interference by one of the following measures:

- Reorient or relocate the receiving antenna.
- Increase the separation between the equipment and receiver.
- Connect the equipment into an outlet on a circuit different from that to which the receiver is connected.
- Consult the dealer or an experienced radio/TV technician for help.

FCC Caution: Any changes or modifications not expressly approved by the party responsible for compliance could void the user's authority to operate this equipment.

This device complies with Part 15 of the FCC Rules. Operation is subject to the following two conditions: (1) This device may not cause harmful interference, and (2) this device must accept any interference received, including interference that may cause undesired operation.



IMPORTANT NOTE:

FCC Radiation Exposure Statement

This equipment complies with FCC radiation exposure limits set forth for an uncontrolled environment. This equipment should be installed and operated with minimum distance 20cm between the radiator & your body.

This transmitter must not be co-located or operating in conjunction with any other antenna or transmitter.

The availability of some specific channels and/or operational frequency bands are country dependent and are firmware programmed at the factory to match the intended destination. The firmware setting is not accessible by the end user.

Europe – EU Declaration of Conformity

TRENDnet hereby declare that the product is in compliance with the essential requirements and other relevant provisions under our sole responsibility.



Safety

EN 60590-1: 2006+A11: 2009+A1: 2010+A12: 2011+A2: 2013

EMC

EN 55022: 2010 + AC: 2011 Class A

EN 50130-4: 2011

This product is herewith confirmed to comply with the Directives.

Directives

Low Voltage Directive 2006/95/EC

EMC Directive 2004/108/EC

RoHS Directive 2011/65/EU

REACH Regulation (EC) No. 1907/2006

Česky [Czech]	TRENDnet tímto prohlašuje, že tento TEW-735AP je ve shodě se základními požadavky a dalšími příslušnými ustanoveními směrnice 2004/108/ES, 2006/95/ES a 2009/125/ES.
Dansk [Danish]	Undertegnede TRENDnet erklærer herved, at følgende udstyr TEW-735AP overholder de væsentlige krav og øvrige relevante krav i direktiv 2004/108/EF, 2006/95/EF og 2009/125/EF.
Deutsch [German]	Hiermit erklärt TRENDnet, dass sich das Gerät TEW-735AP in Übereinstimmung mit den grundlegenden Anforderungen und den übrigen einschlägigen Bestimmungen der Richtlinie 2004/108/EG, 2006/95/EG und 2009/125/EG befindet.
Eesti [Estonian]	Käesolevaga kinnitab TRENDnet seadme TEW-735AP vastavust direktiivi 2004/108/EÜ, 2006/95/EÜ ja 2009/125/EÜ põhinõuetele ja nimetatud direktiivist tulenevatele teistele asjakohastele sätetele.
English	Hereby, TRENDnet, declares that this TEW-735AP is in compliance with the essential requirements and other relevant provisions of Directive 2004/108/CE, 2006/95/CE, and 2009/125/CE.
Español [Spanish]	Por medio de la presente TRENDnet declara que el TEW-735AP cumple con los requisitos esenciales y cualesquiera otras disposiciones aplicables o exigibles de la Directiva 2004/108/CE, 2006/95/CE y 2009/125/CE.
Ελληνική [Greek]	ΜΕ ΤΗΝ ΠΑΡΟΥΣΑ ΤΡΕΝΔΝΕΤ ΔΗΛΩΝΕΙ ΟΤΙ ΤΕW-735ΑΡ ΣΥΜΜΟΡΦΩΝΕΤΑΙ ΠΡΟΣ ΤΙΣ ΟΥΣΙΩΔΕΙΣ ΑΠΑΙΤΗΣΕΙΣ ΚΑΙ ΤΙΣ ΛΟΙΠΕΣ ΣΧΕΤΙΚΕΣ ΔΙΑΤΑΞΕΙΣ ΤΗΣ ΟΔΗΓΙΑΣ 2004/108/ΕΚ, 2006/95/ΕΚ, 2009/125/ΕΚ και.
Français [French]	Par la présente TRENDnet déclare que l'appareil TEW-735AP est conforme aux exigences essentielles et aux autres dispositions pertinentes de la directive 2004/108/CE, 2006/95/CE et 2009/125/CE.
Italiano [Italian]	Con la presente TRENDnet dichiara che questo TEW-735AP è conforme ai requisiti essenziali ed alle altre disposizioni pertinenti stabilite dalla direttiva 2004/108/CE, 2006/95/CE e 2009/125/CE.
Latviski [Latvian]	Ar šo TRENDnet deklarē, ka TEW-735AP atbilst Direktīvas 2004/108/EK, 2006/95/EK un 2009/125/EK būtiskajām prasībām un citiem ar to saistītajiem noteikumiem.
Lietuvių [Lithuanian]	Šiuo TRENDnet deklaruojama, kad šis TEW-735AP atitinka esminius reikalavimus ir kitas 2004/108/EB, 2006/95/EB ir 2009/125/EB Direktyvos nuostatas.
Nederlands [Dutch]	Hierbij verklaart TRENDnet dat het toestel TEW-735AP in overeenstemming is met de essentiële eisen en de andere relevante bepalingen van richtlijn 2004/108/EG, 2006/95/EG en 2009/125/EG.

Malti [Maltese]	Hawnhekk, TRENDnet, jiddikjara li dan TEW-735AP jikkonforma mal-htigijiet essenzjali u ma provvedimenti oħrajn relevanti li hemm fid-Dirrettiva 2004/108/KE, 2006/95/KE u 2009/125/KE.
Magyar [Hungarian]	Alulírott, TRENDnet nyilatkozom, hogy a TEW-735AP megfelel a vonatkozó alapvető követelményeknek és az 2004/108/EK, 2006/95/EK és a 2009/125/EK irányelv egyéb előírásainak.
Polski [Polish]	Niniejszym TRENDnet oświadcza, że TEW-735AP jest zgodny z zasadniczymi wymogami oraz pozostałymi stosownymi postanowieniami Dyrektywy 2004/108/WE, 2006/95/WE i 2009/125/WE.
Português [Portuguese]	TRENDnet declara que este TEW-735AP está conforme com os requisitos essenciais e outras disposições da Directiva 2004/108/CE, 2006/95/CE e 2009/125/CE.
Slovensko [Slovenian]	TRENDnet izjavlja, da je ta TEW-735AP v skladu z bistvenimi zahtevami in ostalimi relevantnimi določili direktive 2004/108/ES, 2006/95/ES in 2009/125/ES.
Slovensky [Slovak]	TRENDnet týmto vyhlasuje, že TEW-735AP spĺňa základné požiadavky a všetky príslušné ustanovenia Smernice 2004/108/ES, 2006/95/ES a 2009/125/ES.
Suomi [Finnish]	TRENDnet vakuuttaa täten että TEW-735AP tyyppinen laite on direktiivin 2004/108/EY, 2006/95/EY ja 2009/125/EY oleellisten vaatimusten ja sitä koskevien direktiivin muiden ehtojen mukainen.
Svenska [Swedish]	Härmed intygar TRENDnet att denna TEW-735AP står i överensstämmelse med de väsentliga egenskapskrav och övriga relevanta bestämmelser som framgår av direktiv 2004/108/EG, 2006/95/EG och 2009/125/EG.

RoHS

This product is RoHS compliant.



Power over Ethernet

The TV-NVR104 has 4 PoE ports and works as a Power Sourcing Equipment (PSE). The 4 PoE ports 15.4 Watts per port to a Powered Device (PD). The network port is standard 10/100 Ethernet port. The total power budget available for all PoE cameras is 35 Watts.

WARNING: The switch should be connected only to PoE networks without routing to the outside plant.

Limited Warranty

TRENDnet warrants its products against defects in material and workmanship, under normal use and service, for the following lengths of time from the date of purchase.

- TV-NVR104 – 2 Years Warranty
- TV-IP320PI – 3 Years Warranty
- Included 1TB Hard Disk Drive – Manufacturer's Warranty

If a product does not operate as warranted during the applicable warranty period, TRENDnet shall reserve the right, at its expense, to repair or replace the defective product or part and deliver an equivalent product or part to the customer. The repair/replacement unit's warranty continues from the original date of purchase. All products that are replaced become the property of TRENDnet. Replacement products may be new or reconditioned. TRENDnet does not issue refunds or credit. Please contact the point-of purchase for their return policies.

TRENDnet shall not be responsible for any software, firmware, information, or memory data of customer contained in, stored on, or integrated with any products returned to TRENDnet pursuant to any warranty.

There are no user serviceable parts inside the product. Do not remove or attempt to service the product by any unauthorized service center. This warranty is voided if (i) the product has been modified or repaired by any unauthorized service center, (ii) the product was subject to accident, abuse, or improper use (iii) the product was subject to conditions more severe than those specified in the manual.

Warranty service may be obtained by contacting TRENDnet within the applicable warranty period and providing a copy of the dated proof of the purchase. Upon proper submission of required documentation a Return Material Authorization (RMA) number will be issued. An RMA number is required in order to initiate warranty service support for all TRENDnet products. Products that are sent to TRENDnet for RMA service must have the RMA number marked on the outside of return packages and sent to TRENDnet prepaid, insured and packaged appropriately for safe shipment. Customers shipping from outside of the USA and Canada are responsible for return shipping fees. Customers shipping from outside of the USA are responsible for custom charges, including but not limited to, duty, tax, and other fees.

WARRANTIES EXCLUSIVE: IF THE TRENDNET PRODUCT DOES NOT OPERATE AS WARRANTED ABOVE, THE CUSTOMER'S SOLE REMEDY SHALL BE, AT TRENDNET'S OPTION, REPAIR OR REPLACE. THE FOREGOING WARRANTIES AND

REMEDIES ARE EXCLUSIVE AND ARE IN LIEU OF ALL OTHER WARRANTIES, EXPRESSED OR IMPLIED, EITHER IN FACT OR BY OPERATION OF LAW, STATUTORY OR OTHERWISE, INCLUDING WARRANTIES OF MERCHANTABILITY AND FITNESS FOR A PARTICULAR PURPOSE.

TRENDNET NEITHER ASSUMES NOR AUTHORIZES ANY OTHER PERSON TO ASSUME FOR IT ANY OTHER LIABILITY IN CONNECTION WITH THE SALE, INSTALLATION MAINTENANCE OR USE OF TRENDNET'S PRODUCTS.

TRENDNET SHALL NOT BE LIABLE UNDER THIS WARRANTY IF ITS TESTING AND EXAMINATION DISCLOSE THAT THE ALLEGED DEFECT IN THE PRODUCT DOES NOT EXIST OR WAS CAUSED BY CUSTOMER'S OR ANY THIRD PERSON'S MISUSE, NEGLIGENCE, IMPROPER INSTALLATION OR TESTING, UNAUTHORIZED ATTEMPTS TO REPAIR OR MODIFY, OR ANY OTHER CAUSE BEYOND THE RANGE OF THE INTENDED USE, OR BY ACCIDENT, FIRE, LIGHTNING, OR OTHER HAZARD.

LIMITATION OF LIABILITY: TO THE FULL EXTENT ALLOWED BY LAW TRENDNET ALSO EXCLUDES FOR ITSELF AND ITS SUPPLIERS ANY LIABILITY, WHETHER BASED IN CONTRACT OR TORT (INCLUDING NEGLIGENCE), FOR INCIDENTAL, CONSEQUENTIAL, INDIRECT, SPECIAL, OR PUNITIVE DAMAGES OF ANY KIND, OR FOR LOSS OF REVENUE OR PROFITS, LOSS OF BUSINESS, LOSS OF INFORMATION OR DATE, OR OTHER FINANCIAL LOSS ARISING OUT OF OR IN CONNECTION WITH THE SALE, INSTALLATION, MAINTENANCE, USE, PERFORMANCE, FAILURE, OR INTERRUPTION OF THE POSSIBILITY OF SUCH DAMAGES, AND LIMITS ITS LIABILITY TO REPAIR, REPLACEMENT, OR REFUND OF THE PURCHASE PRICE PAID, AT TRENDNET'S OPTION. THIS DISCLAIMER OF LIABILITY FOR DAMAGES WILL NOT BE AFFECTED IF ANY REMEDY PROVIDED HEREIN SHALL FAIL OF ITS ESSENTIAL PURPOSE.

Governing Law: This Limited Warranty shall be governed by the laws of the state of California.

Some TRENDnet products include software code written by third party developers. These codes are subject to the GNU General Public License ("GPL") or GNU Lesser General Public License ("LGPL").

Go to <http://www.trendnet.com/gpl> or <http://www.trendnet.com> Download section and look for the desired TRENDnet product to access to the GPL Code or LGPL Code. These codes are distributed WITHOUT WARRANTY and are subject to the copyrights of the developers. TRENDnet does not provide technical support for these codes. Please go to <http://www.gnu.org/licenses/gpl.txt> or <http://www.gnu.org/licenses/lgpl.txt> for specific terms of each license.

January 6, 2015

TV-NVR104K (v1.0R) User's Guide V1.2



Product Warranty Registration

Please take a moment to register your product online.
Go to TRENDnet's website at <http://www.trendnet.com/register>

TRENDnet
20675 Manhattan Place
Torrance, CA 90501. USA