

USER MANUAL

ProLite

LCD Monitor

ENGLISH

ProLite LH5050UHS
ProLite LH5550UHS
ProLite LH6550UHS

Thank you very much for choosing the iiyama LCD monitor.

We recommend that you take a few minutes to read this comprehensive manual carefully before installing and switching on the monitor. Please keep this manual in a safe place for your future reference.

CE MARKING DECLARATION OF CONFORMITY

This LCD monitor complies with the requirements of the EC/EU Directive 2014/30/EU "EMC Directive", 2014/35/EU "Low Voltage Directive" and 2011/65/EU "RoHS Directive".

Warning

This is a class A product. In a domestic environment this product may cause radio interference in which case the user may be required to take adequate measures.

IYAMA CORPORATION: Wijkmeerstraat 8, 2131 HA Hoofddorp, The Netherlands

Model No. : PL5050, PL5550, PL6550



We recommend recycling of used product. Please contact your dealer or iiyama service center. Recycle information is obtained via the Internet, using the address: <http://www.iiyama.com>

You can access the Web page of different countries from there.

- We reserve the right to change specifications without notice.
- All trademarks used in this user manual are the property of their respective owners.

TABLE OF CONTENTS

| | |
|---|----|
| FOR YOUR SAFETY..... | 1 |
| SAFETY PRECAUTIONS..... | 1 |
| SPECIAL NOTES ON LCD MONITORS | 3 |
| CUSTOMER SERVICE | 5 |
| CLEANING | 5 |
| BEFORE YOU OPERATE THE MONITOR..... | 6 |
| FEATURES..... | 6 |
| CHECKING THE CONTENTS OF THE PACKAGE | 6 |
| UNPACKING | 7 |
| CONTROLS AND CONNECTORS : MONITOR..... | 8 |
| INSTALLATION | 10 |
| CONTROLS AND CONNECTORS : REMOTE CONTROL..... | 12 |
| PREPARING THE REMOTE CONTROL..... | 13 |
| BASIC OPERATION..... | 14 |
| CONNECTING YOUR MONITOR..... | 17 |
| COMPUTER SETTING | 21 |
| OPERATING THE MONITOR..... | 22 |
| ADJUSTMENT MENU CONTENTS..... | 24 |
| POWER MANAGEMENT FEATURE..... | 35 |
| TROUBLE SHOOTING | 36 |
| RECYCLING INFORMATION..... | 37 |
| APPENDIX | 38 |
| SPECIFICATIONS : ProLite LH5050UHS | 38 |
| SPECIFICATIONS : ProLite LH5550UHS | 39 |
| SPECIFICATIONS : ProLite LH6550UHS | 40 |
| DIMENSIONS : ProLite LH5050UHS | 41 |
| DIMENSIONS : ProLite LH5550UHS | 41 |
| DIMENSIONS : ProLite LH6550UHS | 42 |
| COMPLIANT TIMING | 43 |

FOR YOUR SAFETY

SAFETY PRECAUTIONS

WARNING

STOP OPERATING THE MONITOR WHEN YOU SENSE TROUBLE

If you notice any abnormal phenomena such as smoke, strange sounds or fumes, unplug the monitor and contact your dealer or iiyama service center immediately. Further use may be dangerous and can cause fire or electric shock.

NEVER REMOVE THE CABINET

High voltage circuits are inside the monitor. Removing the cabinet may expose you to the danger of fire or electric shock.

DO NOT PUT ANY OBJECT INTO THE MONITOR

Do not put any solid objects or liquids such as water into the monitor. In case of an accident, unplug your monitor immediately and contact your dealer or iiyama service center. Using the monitor with any object inside may cause fire, electric shock or damage.

INSTALL THE MONITOR ON A FLAT, STABLE SURFACE

The monitor may cause an injury if it falls or is dropped.

DO NOT USE THE MONITOR NEAR WATER

Do not use where water may be splashed or spilt onto the monitor as it may cause fire or electric shock.

OPERATE UNDER THE SPECIFIED POWER SUPPLY

Be sure to operate the monitor only with the specified power supply. Use of an incorrect voltage will cause malfunction and may cause fire or electric shock.

PROTECT THE CABLES

Do not pull or bend the power cable and signal cable. Do not place the monitor or any other heavy objects on the cables. If damaged, the cables may cause fire or electric shock.

ADVERSE WEATHER CONDITIONS

It is advisable not to operate the monitor during a heavy thunder storm as the continual breaks in power may cause malfunction. It is also advised not to touch the plug in these circumstances as it may cause electric shock.

CAUTION

INSTALLATION LOCATION

Do not install the monitor where sudden temperature changes may occur, or in humid, dusty or smoky areas as it may cause fire, electric shock or damage. You should also avoid areas where the sun shines directly on the monitor.

DO NOT PLACE THE MONITOR IN A HAZARDOUS POSITION

The monitor may topple and cause injury if not suitably located. Please also ensure that you do not place any heavy objects on the monitor, and that all cables are routed such that children may not pull the cables and possibly cause injury.

MAINTAIN GOOD VENTILATION

Ventilation slots are provided to keep the monitor from overheating. Covering the slots may cause fire. To allow adequate air circulation, place the monitor at least 10 cm (or 4 inches) from any walls.

Do not remove the tilt stand when operating the monitor. Ventilation slots on the back of the cabinet will be blocked and the monitor may overheat if the stand is removed. This may cause fire or damage. Operating the monitor on its back, side, upside down or on a carpet or any other soft material may also cause damage.

DISCONNECT THE CABLES WHEN YOU MOVE THE MONITOR

When you move the monitor, turn off the power switch, unplug the monitor and be sure the signal cable is disconnected. If you do not disconnect them, it may cause fire or electric shock.

UNPLUG THE MONITOR

If the monitor is not in use for a long period of time it is recommended that it is left unplugged to avoid accidents.

HOLD THE PLUG WHEN DISCONNECTING

To disconnect the power cable or signal cable, always pull it by the plug. Never pull on the cable itself as this may cause fire or electric shock.

DO NOT TOUCH THE PLUG WITH WET HANDS

Pulling or inserting the plug with wet hands may cause electric shock.

WHEN YOU INSTALL THE MONITOR ON YOUR COMPUTER

Be sure the computer is strong enough to hold the weight of the monitor, otherwise, you may damage your computer.

REMARK FOR 24/7 USAGE

This product is not specifically designed for 24/7 usage. (Recommended operating time is 18 hours/Day.)

OTHERS

ERGONOMIC RECOMMENDATIONS

To eliminate eye fatigue, do not operate the monitor against a bright background or in a dark room. For optimal viewing comfort, the monitor should be just below eye level and 40-60 cm (16-24 inches) away from your eyes. When using the monitor over a prolonged time, a ten minute break every hour is recommended as looking at the screen continuously can cause eye strain.

SPECIAL NOTES ON LCD MONITORS

- The following symptoms are normal with LCD monitors and do not indicate a problem.

NOTE

- When you first turn on the LCD monitor, the picture may not fit in the display area because of the type of computer that is used. In this case, adjust the picture position to the correct position.
 - You may find slightly uneven brightness on the screen depending on the desktop pattern you use.
 - Due to the nature of the LCD screen, an afterimage of the previous screen may remain after switching the image, when the same image is displayed for hours. In this case, the screen is recovered slowly by changing the image or turning off the Power Switch for hours.
- This LCD cannot be used outdoors.
 - This LCD cannot be used with the screen facing upwards.
 - If you use a cable longer than the supplied one, the picture quality is not guaranteed. Touch function can be disrupted if the USB cable length exceeds 3m.

USAGE CONFIRMATION

This product is designed for optimum usage at 18hours per day.

The display is compatible for usage in Landscape/Portrait applications, not available Table top (Face-up) applications..

IMAGE PERSISTENCE / IMAGE STICKING

Please be aware that all LCD screens can experience Image Persistence or Image Sticking. This occurs when a residual image remains visible on a screen when static images are displayed for long periods of time. LCD Image Persistence is not permanent but constant images being displayed for a long period of time should be avoided.

To counteract Image Persistence, turn off the monitor for as long as the previous image was displayed, so if an image was on the monitor for 1 hour and there is evidence of a residual or “ghost” image, you should turn off the monitor for 1 hour in order to clear the residual image.

For all LFD products, iiyama recommends displaying moving images and utilising a moving screen saver at regular intervals whenever the screen is idle. You could also turn off the monitor when not in use to assist the prevention.

Other ways to reduce the risk of Image Persistence will be to utilise the FAN-on function (if available), Low Backlight and Low Brightness settings.

FOR EXTENDED USE AS A PUBLIC DISPLAY

■ Image Sticking on LCD Panel

When a static image is displayed for hours, an electric charge trace remains near the electrode inside the LCD producing a “ghost” image. (Image Persistence).

Image Persistence is not a permanent feature.

■ Recommendations

To prevent Image Sticking and promote longer life expectancy of display, we recommend the following:

1. Avoid static images displayed for long periods – change static images on continuous loop.
2. Turn off monitor when not in use, either by remote control or use Power Management or Schedule functions.
3. When monitor is installed in high ambient temperature environment(s) or in an enclosed position, utilise the Cooling Fan, Screen Saver and Low Brightness functions.
4. Suitable ventilation for any monitor is an expectation of any installation – climate control systems may need to be employed.
5. We strongly recommend utilisation of active cooling with fans for long operation times or high ambient temperature environments.

CUSTOMER SERVICE

NOTE

- If you have to return your unit for service and the original packaging has been discarded, please contact your dealer or iiyama service center for advice or replacement packaging.

CLEANING

WARNING

- If you drop any materials or liquids such as water into the monitor when cleaning, unplug the power cable immediately and contact your dealer or iiyama service center.

CAUTION

- For safety reasons, turn off the power switch and unplug the monitor before you clean it.

NOTE

- To protect the LCD panel, do not scratch or rub the screen with a hard object.
- Never use any of the following strong solvents. These will damage the cabinet and the LCD screen.

| | | |
|--------------------|---------|--------------------------|
| Thinner | Benzine | Abrasive cleaner |
| Spray-type cleaner | Wax | Acid or Alkaline solvent |

- Touching the cabinet with any product made from rubber or plastic for a long time may cause degeneration or loss of paint on the cabinet.

CABINET

Stains can be removed with a cloth lightly moistened with a mild detergent solvent. Then wipe the cabinet with a soft dry cloth.

LCD

Periodic cleaning with a soft dry cloth is recommended.

SCREEN

Don't use tissue paper etc. because these will damage the LCD screen.

BEFORE YOU OPERATE THE MONITOR

FEATURES

- ◆ Supports Resolutions up to 3840 × 2160
- ◆ High Contrast 4000:1 (Typical) / Brightness 450cd/m² (Typical)
- ◆ Digital Character Smoothing
- ◆ Automatic Set-up
- ◆ Stereo Speakers
2 × 10W Stereo Speakers
- ◆ Plug & Play VESA DDC2B Compliant
Windows[®] 7/8.1/10 Compliant
- ◆ Power Management (VESA DPMS Compliant)
- ◆ VESA Mounting Standard (400mm×400mm) Compliant

ENGLISH

CHECKING THE CONTENTS OF THE PACKAGE

The following accessories are included in your package. Check to see if they are enclosed with the monitor. If anything is missing or damaged, please contact your local iiyama dealer or regional iiyama office.

- | | | |
|------------------------|-------------------|---------------------|
| ■ Power Cable* | ■ HDMI Cable | ■ DisplayPort Cable |
| ■ Remote Control | ■ Battery (2pcs) | ■ Bracket |
| ■ Bracket Screw (4pcs) | ■ Cable Ties | ■ POP Label |
| ■ iiyama Logo Sticker | ■ EU Energy Label | ■ Safety Guide |
| ■ Quick Start Guide | | |

CAUTION

* The rating of the Power Cable enclosed in 120V area is 10A/125V. If you are using a power supply higher than this rating, then a power cable with a rating of 10A/250V must be used. However, all guarantees and warranties are void for any problems or damage caused by a power cable not supplied by iiyama.

An approved power cord greater or equal to H05VVf, 3G, 0.75mm² must be used.

UNPACKING

- ① Before unpacking your monitor, prepare a stable, level, and clean surface near a wall outlet. Set the LCD Monitor box in an upright position and open from the top of the box before removing the top cushions.
- ② Remove the carton holders.
- ③ Remove the top cushion and take the accessories box and the Monitor out.

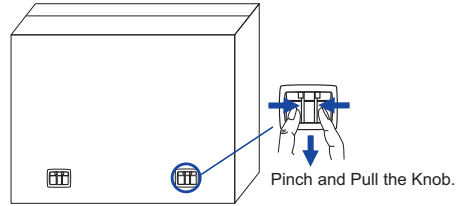

CAUTION

Moving the monitor requires at least two people. If not, it may drop and could result in a serious injury.

When moving/shipping the monitor, please hold by the carton holders.



CONTROLS AND CONNECTORS : MONITOR

<Controller>

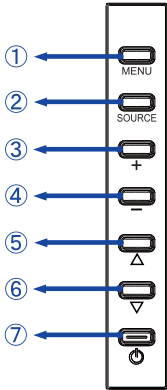

| | | |
|---|--------|----------------------|
| ① | MENU | Menu Button |
| ② | SOURCE | Input Select Button, |
| ③ | + | + Button |
| ④ | - | - Button |
| ⑤ | ▲ | Up Button |
| ⑥ | ▼ | Down Button |
| ⑦ | ⏻ | Power Button |

<Front>



<Back>



| | | | |
|---|-----------------|-------|---|
| ⑧ | Power Indicator | Green | Normal Operation |
| | | Red | Flash : Power Management Lighting : If turn off the Power Button on the Remote Control and the Controller. |
| | | | Power Off |
| ⑨ | Remote Sensor | | Remote Sensor |

<Remote sensor and power indicator - location>

1. Pull down the lens to improve remote control performance and ensure good visibility of the power status diode.
2. Push up the lens before mounting the monitor for video wall application.
3. Pull/Push the lens until hearing the click sound.

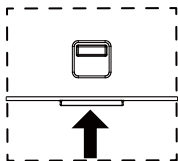

Push up to hide the lens

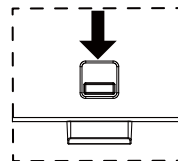

Push down to extend the lens

<Back>

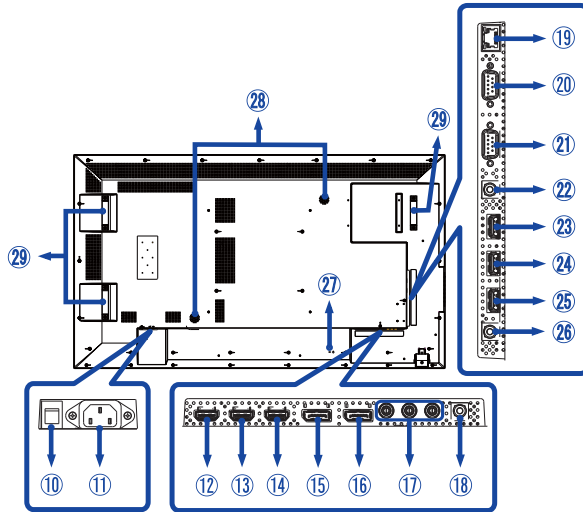

| | | | |
|-------------|----------------------------------|---------------|--|
| ⑩ | AC SWITCH I (ON) / O (OFF) | MAIN POWER | Main Power Switch |
| ⑪ | AC IN | AC-INLET | AC Connector(~ : Alternating current) (AC-IN) |
| ⑫ ⑬ ⑭ | HDMI1 HDMI2 HDMI3 | HDMI | HDMI Connector |
| ⑮ | DP IN | DisplayPort | DisplayPort Connector |
| ⑯ | DP OUT | DisplayPort | DisplayPort Connector |
| ⑰ | COMPONENT VIDEO (VIDEO IN) | RCA G/B/R | Component Video Connector |
| ⑱ | AUDIO IN (PC Audio In) | Mini Jack | Audio Connector |
| ⑲ | RJ45 | RJ45 | RJ45 Connector |
| ⑳ | RS232C IN | RS232C 9pin | RS232C Connector |
| ㉑ | RS232C OUT | RS232C 9pin | RS232C Connector |
| ㉒ | IR IN | IR | IR Connector |
| ㉓ ㉔ | USB2.0 | USB | USB Connector for USB media player |
| ㉕ | USB3.0 | USB | USB Connector for USB media player |
| ㉖ | AUDIO OUT | RCA L/R | Headphone connector |
| ㉗ | Keyhole for Security Lock | | Keyhole for Security Lock |
| ㉘ | Speakers | | Speakers, Lautsprecher |
| ㉙ | Handles* | | Handles |

* Available for ProLite LH6550UHS only.

BEFORE YOU OPERATE THE MONITOR 9

INSTALLATION

CAUTION

- Follow the manual instructions for the type of mount you have selected. Refer all servicing to qualified service personnel.
- Moving the monitor requires at least two people.
- Before installing, please make sure the wall is strong enough to hold the necessary weight of the display and the mount.
- Operating the display at a different angle or in a different position other than specified in this manual will void the manufacturer's warranty.

[WALL MOUNTING]

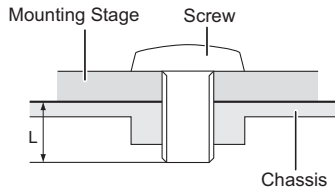

CAUTION

When using the wall mounting, consideration of thickness of the mounting stage needs to be taken. Tighten the M6 Screw with washer which "L" length is 15mm to fasten the monitor. Using a screw longer than this may cause electric shock or damage because it may contact with the electrical parts inside the monitor.

Do not install or operate the display in face-down or face-up position.

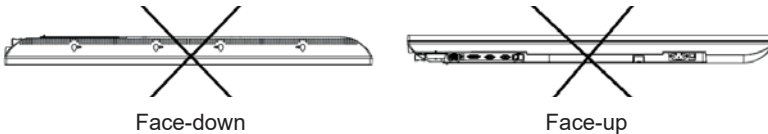

[INSTALLING THE MINI PC TO THE MONITOR]

Attach the mini PC to the included Bracket and screw it to the back of the monitor.

For the installation method of the mini PC, please refer to the operation manual of the mini PC.

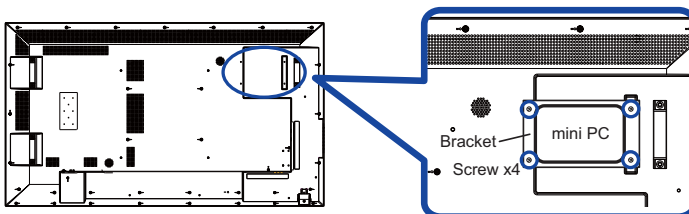

[ROTATING THE DISPLAY]

It is designed to be compatible in both landscape and portrait modes.

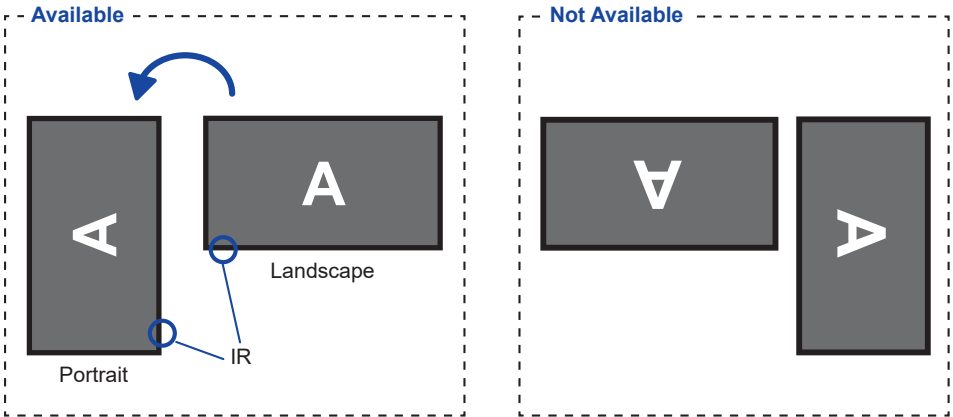

ENGLISH

[ANGLE]

The display needs to be installed at an angle between 0 and 15 degrees for both portrait and landscape operation.

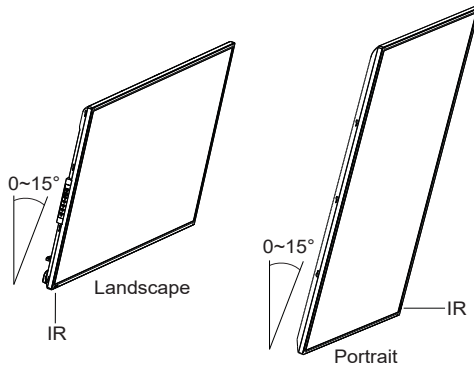

CONTROLS AND CONNECTORS : REMOTE CONTROL

ENGLISH

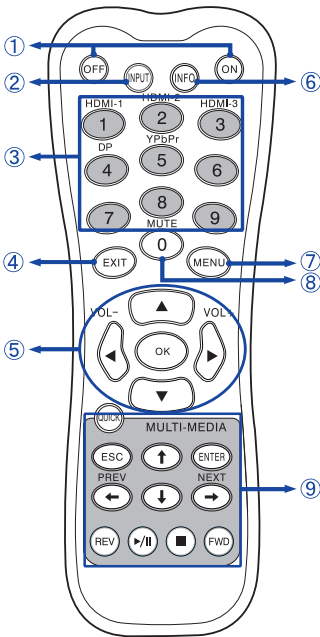

| | | |
|---|-----------------------------|---|
| ① | ON/OFF | Turns the monitor ON and OFF. |
| ② | INPUT | Selects the source. |
| ③ | Number (1-9) / Input source | Serve as input source buttons when the Menu is not displayed. |
| ④ | EXIT | Returns to a previous menu or closes the OSD Menu. |
| ⑤ | ▲▼◀▶ | <p>Navigates through submenus and settings.</p> <p>▲: Up Button ▼: Down Button ◀: Left Button ▶: Right Button ◀ (VOLUME-): Decreases the sound volume. ▶ (VOLUME+): Increases the sound volume.</p> |
| | OK | Confirms your selection or save changes. |
| ⑥ | INFO | Provides source, resolution and Monitor ID information. |
| ⑦ | MENU | Opens the monitor's on-screen menu systems. When the menu system is already open, pressing this button will return to Main menu. |
| ⑧ | Number (0)/ MUTE | Turns on or off the mute function when the Menu is not displayed. |
| ⑨ | MULTI-MEDIA | <p>QUICK: Open the Quick menu. When the menu system is already open, pressing this button will EXIT menu.</p> <p>ESC: Goes back to the previous page.</p> <p>ENTER: Activates the selected menu item.</p> <p>◀-(PREV)/ ↑ / ↓ / →-(NEXT): Directional arrows for selecting a desired item.</p> <p>REV: Quick-Return</p> <p>▶ / : Play / Pause</p> <p>■ : Stop</p> <p>FWD: Fast-Forward</p> |
| | | |

PREPARING THE REMOTE CONTROL

To use the remote control, insert the two dry batteries.

CAUTION

Do not use any other batteries other than those specified in this manual for the Remote Control. Do not insert old and new batteries together in the Remote Control. Make sure that the terminals match the "+" and "-" indications in the battery compartment. Burst batteries or the electrolyte from these batteries may cause stains, fire or injury.

- ① Slide back and remove the battery cover in the direction of the arrow.

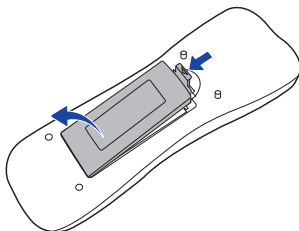

- ② Align and insert two AAA batteries according to their plus and minus ports (as indicated in the remote control).

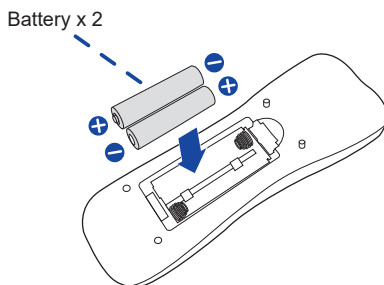

- ③ Replace the battery cover in the direction of the arrow and snap it back into place.

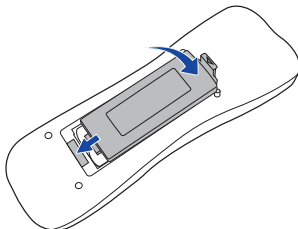

NOTE

- Replace with new batteries when the Remote Control does not work close to the monitor. Use AAA dry batteries.
- Operate the Remote Control by pointing it toward the Remote Sensor on the monitor.
- Other manufacturers remote control will not work with this monitor. Use the provided Remote Control ONLY.
- Used batteries needed to follow the local rules to be discarded. (Suggestion: to dispose of used batteries please follow correct policy as per your local regulations.)

BASIC OPERATION

■ Turning the monitor ON

The monitor is turned On and the Power Indicator turns to Green when you press the POWER Button on the monitor or the Remote Control. The monitor is turned Off and the Power Indicator turns to Red when you press the POWER Button on the monitor or the Remote Control.

Press again to turn On the monitor.

NOTE

Even when using the power management mode or turning OFF the Power Switch, the monitor will consume a small amount of electricity. Disconnect the Power Cable from the power supply whenever the monitor is not in use or during the night, to avoid unnecessary power consumption.

[Monitor]

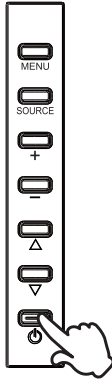

[Remote Control]

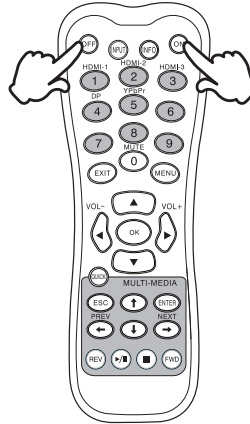

■ Display the adjustment menu page

The menu page appears on the screen when you press the MENU Button on the monitor or the Remote Control.

The menu page disappears when you press the EXIT Button on the Remote Control again.

[Monitor]

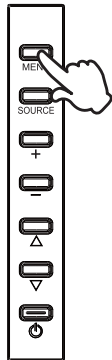

[Remote Control]

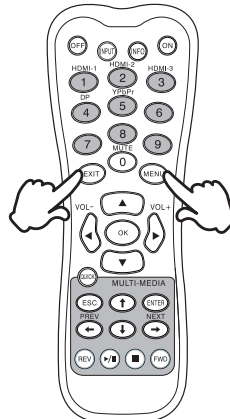

■ Move the cursor vertically

Select adjustment by pressing the ▲ / ▼ Button while the menu page is displayed on the screen.

[Monitor]



[Remote Control]

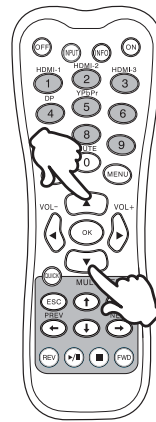

■ Move the cursor horizontally

Select menu or setting, or perform the adjustment by pressing the + / - Button on the monitor or the ◀ / ▶ Button on the Remote Control while the menu page is displayed on the screen.

[Monitor]



[Remote Control]

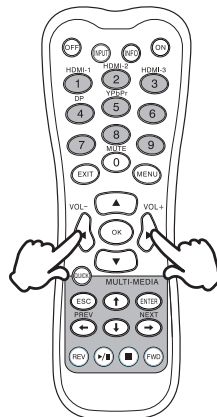

■ **Adjust the volume of sound**

Press the + / - Button on the monitor or the ◀ / ▶ Button on the Remote Control to adjust the volume of sound when the menu page is not displayed on the screen.

[Monitor]



[Remote Control]

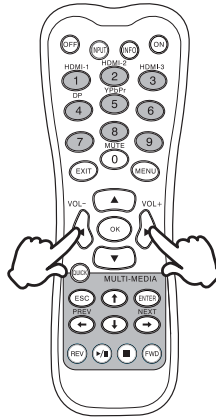

■ **Switch the input signal**

Press the SOURCE Button on the monitor or direct input source select Button or INPUT Button on the Remote Control to display the Input signal menu when the menu page is not displayed on the screen. Press the ▲ / ▼ Button or Input source Button to switch the Input signal.

[Monitor]



[Remote Control]

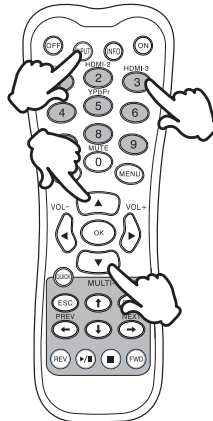

CONNECTING YOUR MONITOR

- ① Ensure that both the computer and the monitor are switched off.
- ② Connect the computer to the monitor with the signal cable.
- ③ Connect the Power Cable to the monitor first and then to the power supply.
- ④ Turn on your monitor (Main Power Switch and Power Switch) and computer.

NOTE

- The signal cables used for connecting the computer and monitor may vary with the type of computer used. An incorrect connection may cause serious damage to both the monitor and the computer. The cable supplied with the monitor is for a standard connector. If a special cable is required please contact your local iiyama dealer or regional iiyama office.
- For connection to Macintosh computers, contact your local iiyama dealer or regional iiyama office for a suitable adaptor.
- Make sure you tighten the finger screws at each end of the Signal Cable.
- The Class I pluggable equipment Type A must be connected to protective earth.
- The socket-outlet shall be installed near the equipment and shall be easily accessible.
- Excessive sound pressure from ear-/headphones can cause hearing damage/hearing loss.

[Example of Connection]

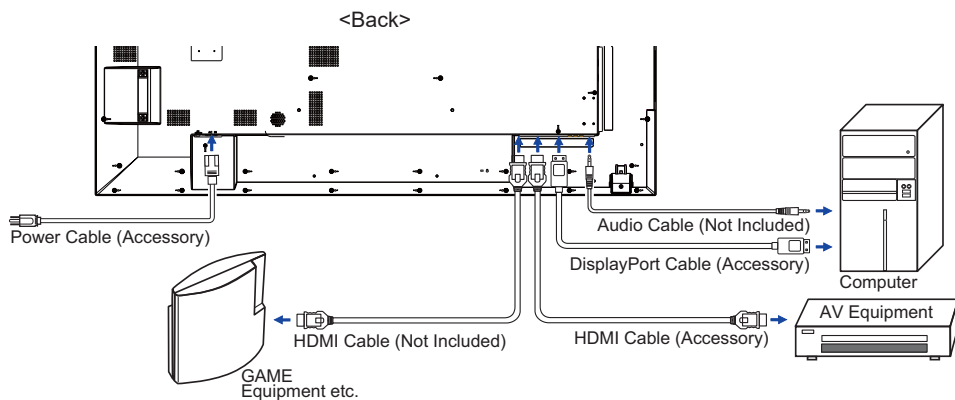

[Connection example with the peripheral device]**CAUTION**

Turn off the power switch and unplug the monitor and peripherals before connection to avoid electric shock or damage.

NOTE

- Refer to the user manual of peripherals at the same time.
- Ensure you have the necessary cables as required.

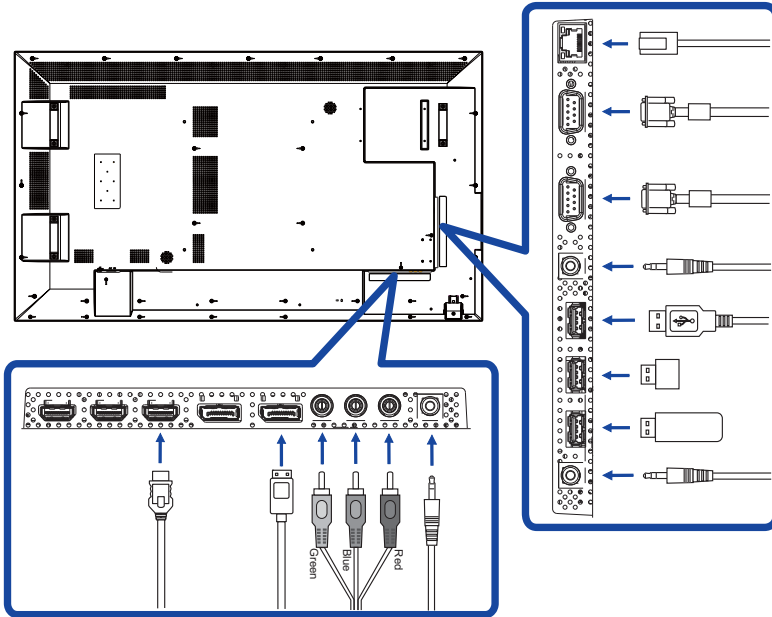

[About the daisy chain]

■ Monitor control connection

RS-232C

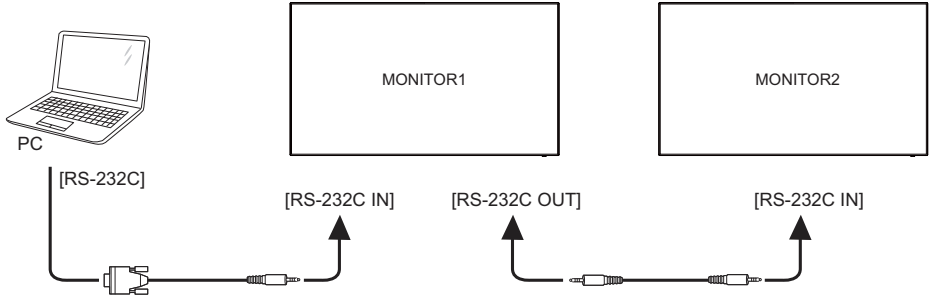

■ Digital video connection

DisplayPort

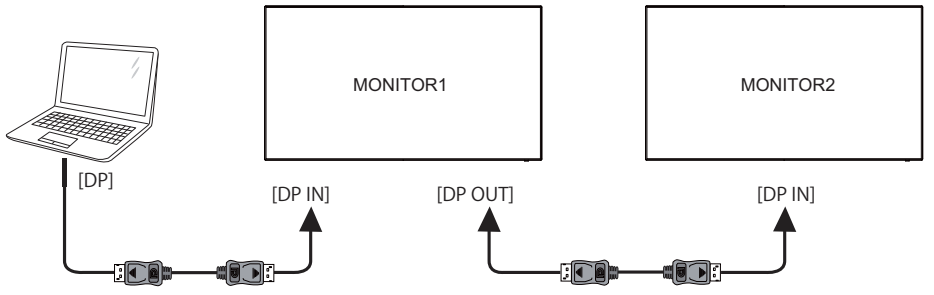

[Network Connection]

● Connecting to a LAN

To set the monitor to connect to a local area network.

1. Connect a RJ45 cable to the corresponding ports on the monitor and your LAN switch or router.
2. Select the LAN in the Control Setting of the OSD menu.
3. Set the Network Settings of the OSD menu. (IP Address Setup / DNS Setup)
4. Save the settings and return to the previous menu.

● Controlling the Monitor

Once you have the correct IP Address for your monitor and the monitor is on or in standby mode, you can use any computer that is on the same local area network to control the monitor.

NOTE • You can not control the monitor via the RS-232C connector when LAN control is in use.
• It is recommended that you use a recent Internet Explorer browser version.

1. Enter the IP Address of the monitor in the address bar of your browser and press ENTER button.

2. Input ID and Password.

ID: admin

Password: system

3. The setting page appears.

INFORMATION / PICTURE&SOUND / SCREEN / SETTING / SCHEDULE / MAIL REPORT / NETWORK

NOTE If you would like to turn on the monitor from a web page.

Make sure the setting > Control setting menu is set to LAN, and the setting > Power Save menu is set to Off.

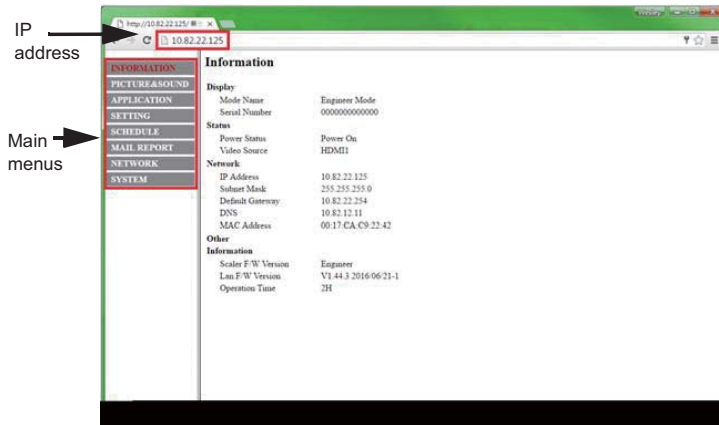

COMPUTER SETTING

- Signal Timing

Change to the desired signal timing listed on page 43: COMPLIANT TIMING.

OPERATING THE MONITOR

To create the best picture, your iiyama LCD monitor has been preset at the factory with the COMPLIANT TIMING shown on page 43. You are also able to adjust the picture by following the button operation shown below.

- 1 Press the MENU button to start the On Screen Display feature. There are additional Menu items which can be switched by using the ▲ / ▼ buttons.

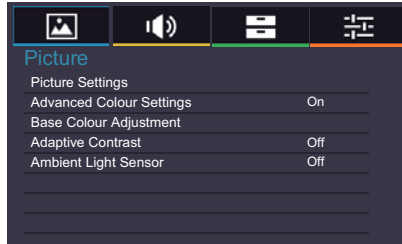

- 2 Select the Menu item of the adjustment you want to make. Press the OK button on the remote control or ENTER button on the monitor and enter the menu page. Then, use the ▲ / ▼ buttons to highlight the desired adjustment item.
- 3 Press the OK button on the remote control or ENTER button on the monitor again. Use the ◀ / ▶ buttons to make the appropriate adjustment or setting.
- 4 Press the EXIT button to leave the menu, and the settings you just made would be automatically saved.

For example, to correct for sharpness, select Menu item of Screen. Select "Picture" by using the ▲ / ▼ buttons. Press the OK button on the remote control. Next, select "Picture Settings" by using the ▲ / ▼ buttons. Press the OK button on the remote control. Then, select "Sharpness" by using the ▲ / ▼ buttons.

Use the ◀ / ▶ buttons to change the sharpness settings. The sharpness of the overall display should be changing accordingly while you are doing this.

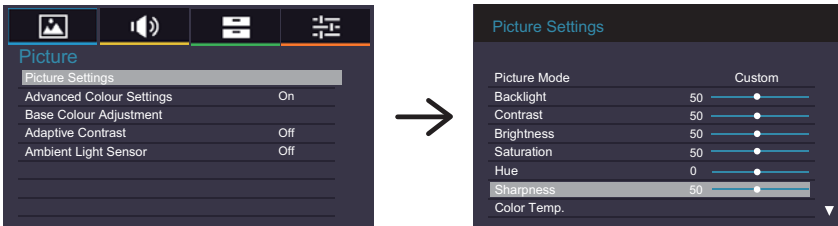

Press the EXIT button on the remote control lastly, it ends, all changes are saved in the memory.

NOTE

- The EXIT button on the remote control can be used to return previous menu item.
- Any changes are automatically saved in the memory when the On Screen Display disappears. Turning off the power should be avoided while using the Menu.

[LOCK MODE]

- **Side Controller Button:** * Available Remote control only.
Pressing and holding the ▲ button for about 5 seconds and then press OK Button when Menu is not displayed, will lock/unlock the Side Controller Button Lock function.









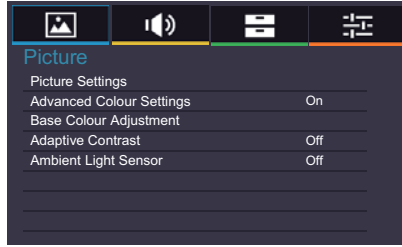

















Direct * Available for Remote Control only.

- **Freeze Function:**
Press the ▼ button and then press 0 button when Menu is not displayed.
Repeat successively to activate/deactivate the function.

ADJUSTMENT MENU CONTENTS

Picture



| Adjustment Item | | Problem / Option | | Button to Press |
|------------------|--------------------------|--------------------------------------|--|--|
| Picture Settings | Picture Mode | Vivid | For displaying outdoor scenery images. | |
| | | Standard | For general windows environment and monitor default setting. | |
| | | Cinema | For movie and video environment. | |
| | | Custom | Displays a picture on a screen set by Image Settings adjustments. | |
| | Backlight* ² | Brightness of back light is reduced. | |   |
| | Contrast | Too dull | |   |
| | | Too intense | |   |
| | Brightness* ¹ | Too dark | |   |
| | | Too bright | |   |
| | Saturation | Too weak | |   |
| Too strong | | |   | |
| Hue | Purplish | |   | |
| | Greenish | |   | |
| Sharpness | Too soft | |   | |
| | Too sharp | |   | |
| Color Temp. | Cool (Bluish white) | Red Level | Too weak   | |
| | Neutral (Greenish white) | Green Level | | Too strong   |
| | Warm (Reddish white) | Blue Level | | |
| | Custom | Reset | No | Return to Menu. |
| | | Yes | Resets all settings in the Color Temp. menu. | |

*¹ Adjust the Brightness when you are using the monitor in a dark room and feel the screen is too bright.

*² Backlight is disabled when the Ambient Light Sensor or Adaptive Contrast is active.

Picture

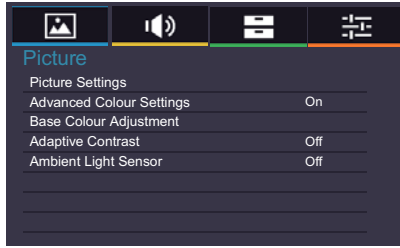

| Adjustment Item | | Problem / Option | | Button to Press |
|--------------------------|--|---|--|--|
| Picture Settings | Noise Reduction | Auto Clean | On | The function reduces (grained) noise of a compressed or converted MPEG signal. It may also improve the quality of blurry pictures. |
| | | | Off | Auto Clean is turned off. |
| | | MPEG NR | Off | MPEG NR is turned off. |
| | | | Low | Sets the MPEG NR noise reduction level. |
| | | | Middle | Sets the MPEG NR noise reduction level more than Low. |
| | | DNR | High | Sets the MPEG NR noise reduction level more than Middle. |
| | | | Off | DNR is turned off. |
| | | | Low | Sets the DNR noise reduction level. |
| | | | Middle | Sets the DNR noise reduction level more than Low. |
| | Reset | High | Sets the DNR noise reduction level more than Middle. | |
| No | | Return to Menu. | | |
| Advanced Colour Settings | Yes | Resets all settings in the Picture Settings menu. | | |
| | On | Enable the Base Color Adjustment. | | |
| Base Colour Adjustment | Off | Disable the Base Color Adjustment. | | |
| | Adjusts the parameter of Hue, Saturation and Brightness. | | | |
| | Red | Too weak Too strong | | |
| | Green | | | |
| | Blue | | | |
| | Yellow | | | |
| | Magenta | | | |
| | Cyan | | | |
| Reset | No | Return to Menu. | | |
| | Yes | Resets all settings in the Base Colour Adjustment menu. | | |
| Adaptive Contrast | On | Enhances image contrast for dark scenes. | | |
| | Off | Adaptive Contrast is turned off. | | |

| Adjustment Item | | Problem / Option | | Button to Press |
|----------------------|--|------------------|--|-----------------|
| Ambient Light Sensor | | On | Automatically adjust image brightness to changing ambient lighting conditions. | |
| | | Off | Ambient Light Sensor is turned off. | |

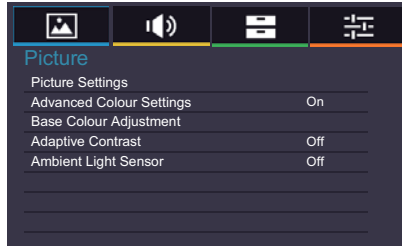

| Adjustment Item | | Problem / Option | | Button to Press | | |
|-------------------------|------------|---|--------------------------------|-----------------|--|--|
| Balance | | Left side speaker louder Right side speaker louder | | ← → ← → | | |
| Advanced Sound Settings | Sound Mode | Clear Voice | Bass | Too weak | ← → | |
| | | Natural | Treble | Too strong | ← → | |
| | | Dynamic | Reset | No | Return to Menu. | |
| | | Standard | | Yes | Resets all settings in the Advanced Sound Settings menu. | |
| Audio Source* | | HDMI | Selects the HDMI input. | | | |
| | | DP | Selects the DisplayPort input. | | | |
| | | Line-In | Selects the Line-In input. | | | |

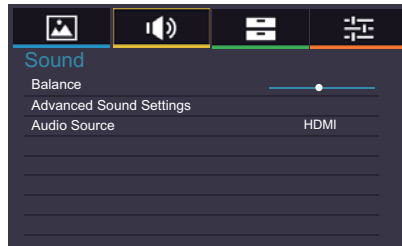

* Suitable for HDMI/DisplayPort input only.



| Adjustment Item | Problem / Option | | Button to Press | |
|-----------------|---|--|--|--|
| Media Player | Photos | Displays a list of Photos in USB memory. | | |
| | Music | Displays a list of Music in USB memory. | | |
| | Videos | Displays a list of Videos in USB memory. | | |
| | Playlist | Displays all support list in USB memory. | | |
| Schedule | Date and Time * | Displays the current date and time. Year/Month/Day/Hour/Minute Time set / Date set | | |
| | Clock Display | On | Displays time. | |
| | | Off | Clock Display is turned off. | |
| On/Off Timer | Sets when to turn on or off the display. On/Off/Input/Everyday/Mon/Tue/Wed/Thu/Fri/Sat/Sun | | | |
| Display Wall | H Monitors | Sets the number of displays used in the horizontal position. | | |
| | V Monitors | Sets the number of displays used in the vertical position. | | |
| | H Position | Sets the horizontal position of the display wall matrix. | | |
| | V Position | Sets the vertical position of the display wall matrix. | | |
| | Frame comp. | On | Adjusts images near the display edges for optimal demonstration across the display wall. | |
| | | Off | Return to Menu. | |
| | Power On Delay | On | All Display wall monitors will power on randomly within 10 seconds. | |
| Off | | Power On Delay is turned off. | | |

* You must set this item when using "On/Off Timer".
You can use number(1-9) on remote control.

Setting

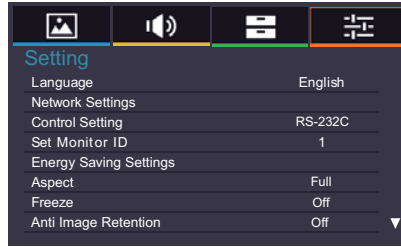

| Adjustment Item | | Problem / Option | | Button to Press | |
|--------------------------------|---------------------------|--------------------------------|--|-----------------|---|
| Language | | English | English | Русский | Russian |
| | | Français | French | Czech | Czech |
| | | Deutsch | German | Italiano | Italian |
| | | Nederlands | Dutch | 日本語 | Japanese |
| | | Polski | Polish | | |
| Network Settings* ¹ | | IP Address Setup | Auto Setup | On | Once you are connected, the IP Address, Subnet mask and Default gateway settings are displayed. |
| | | | | Off | If you are not connected, contact your IT administrator for information on the IP Address, Subnet mask and Default gateway settings and enter them accordingly. |
| | | DNS Setup | Auto Setup | On | Once you are connected, the Primary DNS settings is displayed. |
| | | | | Off | If you are not connected, contact your IT administrator for information on the Primary DNS settings and enter them accordingly. |
| | | MAC Address | Displays the address of the MAC which is connected. | | |
| Control Setting | | RS-232C | Selects the RS-232C to control the display. | | |
| | | LAN | Selects this option to control the display via LAN. | | |
| | | IR Passthrough | Selects this option if multiple displays are connected via RS-232C cables. Primary/Secondary NOTE To reset to the default settings (IR Passthrough Primary, press the INFO button on the remote control for 5 seconds. | | |
| Set Monitor ID * ² | | Set ID to the Monitor. 1-98 | | | |
| Energy Saving Settings | Power Save * ³ | On | All input sources can activate entering the power saving mode, but only the VGA signal can deactivate it. If an another input source is connected you have to press the POWER button. | | |
| | | Off | Power Save is turned off. | | |

*¹ Available when "LAN" selected on control setting.

*² For use under the RS-232C control mode.

*³ RS-232C can bring any mode out of the power saving status.

| Adjustment Item | | Problem / Option | | Button to Press |
|------------------------|----------------------|------------------|--|-----------------|
| Energy Saving Settings | Automatic Power Down | On | Enable the Automatic Power Down function. NOTE <ul style="list-style-type: none"> The monitor will turn off automatically after 3 hours without any key operation. When this function is on, pressing the ▲ button and then the 0(MUTE) button on the remote control can turn this function off. | |
| | | Off | Automatic Power Down is turned off. | |
| Aspect | | Normal | Enlarge the picture, keeping its original aspect ratio. | |
| | | Real | Displays all picture in 4:3 aspect ratio. | |
| | | Full | Enlarge the picture horizontally to fill the screen if the picture source is 4:3 (standard definition). When the picture source is 16:9 (high definition), it is not scaled. | |
| Freeze | Direct | On | Freezes the picture. | |
| | | Off | Freeze is turned off. | |
| Anti Image Retention | | On | Automatically displays swift moving patterns every 1 second to prevent image retention on the screen. | |
| | | Off | Image Retention is turned off. | |
| OSD Rotation | | Landscape | Landscape display | |
| | | Portrait | Portrait display | |
| OSD Info Box | | On | Switching signal inputs, or changing timing, the current input source and resolution information will be displayed on the screen. | |
| | | Off | OSD Info Box is turned off. | |
| DP1.2 | | On | Set DisplayPort version to 1.2. | |
| | | Off | DP1.2 is turned off. | |
| LED | | On | The power indicator is turned on. | |
| | | Off | The power indicator is turned off. | |
| Opening Logo | | On | iiyama Logo displayed when the monitor is turned on. | |
| | | Off | iiyama Logo does not display when the monitor is turned on. | |

Direct

See page 23 for Direct.

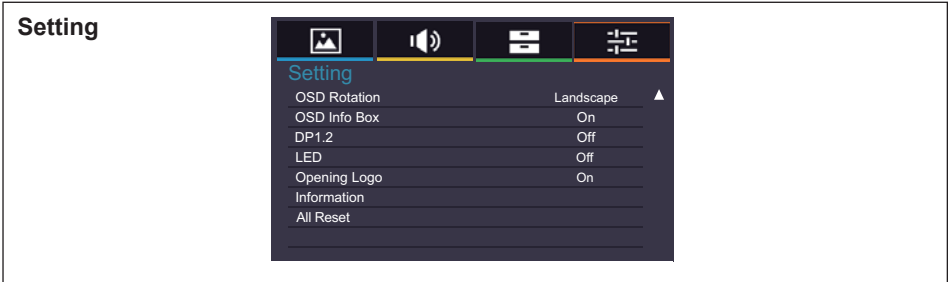

| Adjustment Item | Problem / Option | | Button to Press |
|-----------------|---|----------------------------------|-----------------|
| Information | Date/Model Name/Serial Number/Operation Time/Software Version/ LAN Version/IP Address* ⁴ NOTE See your graphic card user guide for more information about changing the resolution and refresh. | | |
| All Reset | No | Return to Menu. | |
| | Yes | Factory-preset data is restored. | |

*⁴ IP address is displayed only when LAN is connected.

[Play Multimedia Files]

You can play photos, music and videos on your monitor from:

- Your computer connected through your network.
- A USB device connected to this monitor.

● Play multimedia files from USB device

To play files on an external USB storage device, simply plug the device into the USB A jack on the monitor.

1. Connect your USB device to the USB port on this monitor.
2. Uses the remote control and follow the On - Screen instructions to operate.

■ Supported file system:

FAT32

■ Supported file format:

- Music: MP3, MP4, WMA, WAV, MKA
- Video: AVI, MPG, MPEG, MOV, MP4, ASF, FLV1, F4V, 3GPP, TRP, TS, TP, M2TS
- Photo: JPEG, BMP, PNG, JIF

● Viewing photo files

<Remote control button functions in thumbnail view>

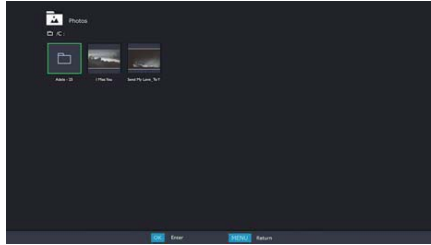

- **OK / ENTER** : Opens the selected photo file.
- **MENU / ESC** : Returns to the Media Player menu.
- **▲ / ▼ / ◀ / ▶** : Directional arrows for selecting a desired photo.
- **EXIT** : Closes the OSD menu or media player.

<Remote control button functions in browse mode>

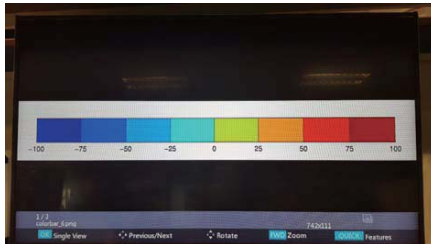

- **OK / ENTER** : Toggles between Slide Show mode or Single View mode.
- **◀** : Plays the previous photo.
- **▶** : Plays the next photo.
- **▲** : Rotates the image 90° clockwise.
- **▼** : Rotates the image 90° counterclockwise.
- **QUICK** : Opens the Quick menu.
- **MENU / ESC** : Goes back to the previous page.
- **FWD** : Zoom in
- **REV** : Zoom out
- **INFO** : Displays the current file status information.
- **EXIT** : Closes the OSD menu or media player.
- **0(MUTE)** : Mutes the sound.

<Quick Menu>

- **Picture Settings** : Opens the Picture Settings menu.
- **Interval Time** : Sets the Slide Show display interval time. 3 - 90 seconds
- **Device Information** : Displays the current device information.
- **Repeat** : Sets repeat function on or off.

●Playing music files

<Remote control button functions in thumbnail view>

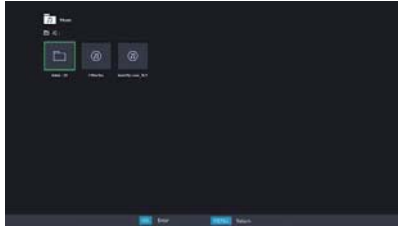

- **OK / ENTER** : Plays the selected music file.
- **MENU / ESC** : Returns to the Media Player menu.
- **▲ / ▼ / ◀ / ▶** : Directional arrows for selecting a desired music.
- **EXIT** : Closes the OSD menu or media player.

<Remote control button functions during playback>



- **←** : Plays the previous music file.
- **→** : Plays the next music file.
- **◀ / VOL-**, **▶ / VOL+** : Turns down/up the volume.
- **QUICK** : Opens the Quick menu.
- **MENU / ESC** : Goes back to the previous page.
- **FWD** : Fast forwards the music. Press repeatedly to change the speed at 1X, 2X, 3X or 4X.
- **REV** : Rewinds the music. Press repeatedly to change the speed at 1X, 2X, 3X or 4X.
- **INFO** : Displays the current file status information.
- **▶ / II** : Plays/pauses the music.
- **■** : Plays the file from the beginning.
- **EXIT** : Closes the OSD menu or media player.
- **0(MUTE)** : Mutes the sound.

<Quick Menu>

- **Sound** : Opens the Advanced Sound Settings menu.
- **Repeat** : Sets the file repeat mode.
 - Off : The file only plays once.
 - All : All files in the same folder play repeatedly.
 - 1 : The same file plays repeatedly.
- **Device Information** : Displays the current device information.

●Playing video files

<Remote control button functions in thumbnail view>

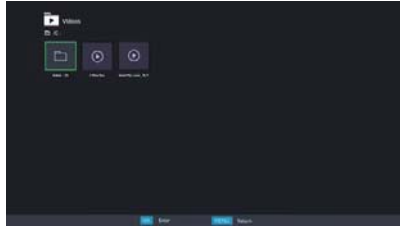

- **OK / ENTER** : Plays the selected video file.
- **MENU / ESC** : Returns to the Media Player menu.
- **▲ / ▼ / ◀ / ▶** : Directional arrows for selecting a desired video.
- **EXIT** : Closes the OSD menu or media player.

<Remote control button functions during playback>



- **◀** : Plays the previous video file.
- **▶** : Plays the next video file.
- **◀ / VOL-, ▶ / VOL+** : Turns down/up the volume.
- **QUICK** : Opens the Quick menu.
- **MENU / ESC** : Goes back to the previous page.
- **FWD** : Fast forwards the video. Press repeatedly to change the speed at 1X, 2X, 3X or 4X.
- **REV** : Rewinds the video. Press repeatedly to change the speed at 1X, 2X, 3X or 4X.
- **INFO** : Displays the current file status information.
- **▶ / ||** : Plays/pauses the video.
- **■** : Plays the file from the beginning.
- **EXIT** : Closes the OSD menu or media player.
- **0(MUTE)** : Mutes the sound.

<Quick Menu>

- **Picture Settings** : Opens the Picture Settings menu.
- **Picture Size** : Sets a preferred picture size. Normal / Wide Zoom / Zoom
- **Sound** : Opens the Advanced Sound Settings menu.
- **Repeat** : Sets the file repeat mode.
 - Off : The file only plays once.
 - All : All files in the same folder play repeatedly.
 - 1 : The same file plays repeatedly.
- **Device Information** : Displays the current device information.

POWER MANAGEMENT FEATURE

The power management feature of this product complies with power saving requirement of VESA DPMS. When activated, it automatically reduces unnecessary power consumption of the monitor when your computer is not in use.

To use the feature, the monitor needs to be connected to a VESA DPMS compliant computer. There is a power management step the monitor takes as described below. The power management function, including any timer settings is configured by the operating system. Check your operating system manual for information on how this can be configured.

■ Power Management Mode

When the H-sync signal / V-sync signal / H and V sync signals from the computer are off, the monitor enters into Power Management Mode which reduces the power consumption to less than 0.5W. The screen becomes dark. From Power Management Mode, the image reappears in several seconds when either the keyboard or the mouse are touched again.

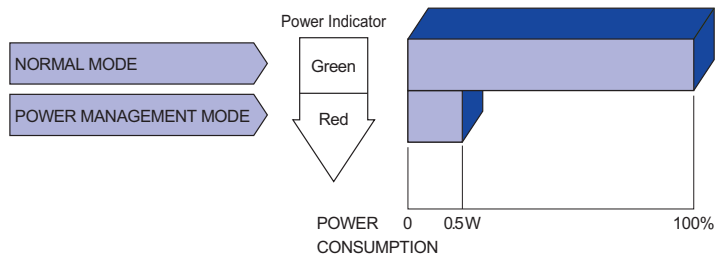

NOTE

- Even when using the power management mode, the monitor consumes electricity. Turn off the Power Switch whenever the monitor is not in use, during the night and weekends, to avoid unnecessary power consumption.
- It is possible that the video signal from the computer may be on while the H or V sync signal is missing. In this instance, the POWER MANAGEMENT feature may not work properly.

TROUBLE SHOOTING

If the monitor fails to operate correctly, please follow the steps below for a possible solution.

1. Perform the adjustments described in OPERATING THE MONITOR, depending on the problem you have. If the monitor does not get a picture, skip to 2.
2. Consult the following items if you cannot find an appropriate adjustment item in OPERATING THE MONITOR or if the problem persists.
3. If you are experiencing a problem which is not described below or you cannot correct the problem, discontinue using the monitor and contact your dealer or iiyama service center for further assistance.

| Problem | Check |
|---|--|
| ① The picture does not appear. | <input type="checkbox"/> The Power Cable is firmly seated in the socket. <input type="checkbox"/> The Power Switch is turned ON. <input type="checkbox"/> The AC socket is live. Please check with another piece of equipment. <input type="checkbox"/> If the blank screen saver is in active mode, touch the keyboard or the mouse. <input type="checkbox"/> Increase the Contrast and/or Brightness. <input type="checkbox"/> The computer is ON. <input type="checkbox"/> The Signal Cable is properly connected. <input type="checkbox"/> The signal timing of the computer is within the specification of the monitor. <input type="checkbox"/> If the monitor is in power management mode, touch the keyboard or the mouse. |
| ② The screen is not synchronized. | <input type="checkbox"/> The Signal Cable is properly connected. <input type="checkbox"/> The signal timing of the computer is within the specification of the monitor. <input type="checkbox"/> The video output level of the computer is within the specification of the monitor. |
| ③ The screen position is not in the center. | <input type="checkbox"/> The signal timing of the computer is within the specification of the monitor. |
| ④ The screen is too bright or too dark. | <input type="checkbox"/> The video output level of the computer is within the specification of the monitor. |
| ⑤ The screen is shaking. | <input type="checkbox"/> The power voltage is within the specification of the monitor. <input type="checkbox"/> The signal timing of the computer is within the specification of the monitor. |
| ⑥ No sound. | <input type="checkbox"/> The audio equipment (computer etc.) is ON. <input type="checkbox"/> The Audio Cable is properly connected. <input type="checkbox"/> The Volume is turned up. <input type="checkbox"/> The Mute is OFF. <input type="checkbox"/> The audio output level of the audio equipment is within the specification of the monitor. |
| ⑦ The sound is too loud or too quiet. | <input type="checkbox"/> The audio output level of the audio equipment is within the specification of the monitor. |
| ⑧ A strange noise is heard. | <input type="checkbox"/> The Audio Cable is properly connected. |

RECYCLING INFORMATION

For better environment protection please don't dispose your monitor.
Please visit our web site: www.iiyama.com/recycle for monitor recycling.

APPENDIX

Design and specifications are subject to change without prior notice.

SPECIFICATIONS : ProLite LH5050UHS

ENGLISH

| | | |
|------------------------------|---|--|
| Size Category | 50" | |
| LCD Panel | Panel technology | D-LED |
| | Size | Diagonal: 50" (126.0cm) |
| | Pixel pitch | 0.2854mm H × 0.2854mm V |
| | Brightness | 450cd/m ² (Typical) |
| | Contrast ratio | 4000 : 1 (Typical) |
| | Viewable angle | Horizontal : 178 degrees, Vertical: 178 degrees (Typical) |
| | Response time | 8ms (Gray to Gray) |
| Display Colors | Approx. 1.07B | |
| Sync Frequency | Horizontal: 30.0-83.0kHz, Vertical: 50-76Hz | |
| Native Resolution | 3840 × 2160, 8.2 MegaPixels | |
| Support Max. Resolution | 3840 × 2160 | |
| Input Connector | HDMI×3, DisplayPort | |
| Input Audio Connector | mini jack | |
| Input Component Connector | RCA (YPbPr) | |
| LAN | RJ45 | |
| Serial Port | RS-232C In/Out | |
| Plug & Play | VESA DDC2B™ | |
| Input Video Signal | Digital: HDMI, DisplayPort | |
| Input Audio Signal | 0.5Vrms maximum | |
| IR Extender Connector | IR | |
| USB Media player | USB2.0×2, USB3.0×1 | |
| Output Connector | DisplayPort | |
| Output Audio Connector | RCA(L/R) | |
| Speakers | 10W×2 (Stereo speakers) | |
| Maximum Screen Size | 1095.84mm W × 616.41mm H / 43.1" W × 24.3" H | |
| Power Source | 100-240VAC, 50-60Hz, 1.8A | |
| Power Consumption* | 140W typical, Power management mode: 0.5W maximum Energy Efficiency Class: C | |
| Dimensions / Net Weight | 1132.5 × 656.0 × 70.0mm / 44.6 × 25.8 × 2.7" (W×H×D) 14.3kg / 31.5lbs | |
| Environmental Considerations | Operating: | Temperature 0 to 40°C / 32 to 104°F Humidity 85% (No condensation) |
| | Storage: | Temperature -20 to 60°C / 4 to 140°F Humidity 85% (No condensation) |
| Approvals | CB, CE, CU, TÜV-Bauart | |

NOTE * Audio equipment are not connected.

SPECIFICATIONS : ProLite LH5550UHS

| | | |
|------------------------------|---|---|
| Size Category | 55" | |
| LCD Panel | Panel technology | D-LED |
| | Size | Diagonal: 55" (139.0cm) |
| | Pixel pitch | 0.315mm H × 0.315mm V |
| | Brightness | 450cd/m ² (Typical) |
| | Contrast ratio | 4000 : 1 (Typical) |
| | Viewable angle | Horizontal : 178 degrees, Vertical: 178 degrees (Typical) |
| | Response time | 8ms (Gray to Gray) |
| Display Colors | Approx.1.07B | |
| Sync Frequency | Horizontal: 30.0-83.0kHz, Vertical: 50-76Hz | |
| Native Resolution | 3840 × 2160, 8.2 MegaPixels | |
| Support Max. Resolution | 3840 × 2160 | |
| Input Connector | HDMI×3, DisplayPort | |
| Input Audio Connector | mini jack | |
| Input Component Connector | RCA (YPbPr) | |
| LAN | RJ45 | |
| Serial Port | RS-232C In/Out | |
| Plug & Play | VESA DDC2B™ | |
| Input Video Signal | Digital: HDMI, DisplayPort | |
| Input Audio Signal | 0.5Vrms maximum | |
| IR Extender Connector | IR | |
| USB Media player | USB2.0×2, USB3.0×1 | |
| Output Connector | DisplayPort | |
| Output Audio Connector | RCA(L/R) | |
| Speakers | 10W×2 (Stereo speakers) | |
| Maximum Screen Size | 1209.6mm W × 680.4mm H / 47.6" W × 26.8" H | |
| Power Source | 100-240VAC, 50-60Hz, 1.8A | |
| Power Consumption* | 160W typical, Power management mode: 0.5W maximum Energy Efficiency Class: C | |
| Dimensions / Net Weight | 1245.0 × 718.5 × 69.0mm / 49.0 × 28.3 × 2.7" (W×H×D) 16.8kg / 37.0lbs | |
| Environmental Considerations | Operating: Temperature | 0 to 40°C / 32 to 104°F |
| | Humidity | 85% (No condensation) |
| | Storage: Temperature | -20 to 60°C / 4 to 140°F |
| | Humidity | 85% (No condensation) |
| Approvals | CB, CE, CU, TÜV-Bauart | |

NOTE * Audio equipment are not connected.

SPECIFICATIONS : ProLite LH6550UHS

| | | |
|------------------------------|------------------|---|
| Size Category | | 65" |
| LCD Panel | Panel technology | D-LED |
| | Size | Diagonal: 65" (164.0cm) |
| | Pixel pitch | 0.372mm H × 0.372mm V |
| | Brightness | 450cd/m ² (Typical) |
| | Contrast ratio | 4000 : 1 (Typical) |
| | Viewable angle | Horizontal : 178 degrees, Vertical: 178 degrees (Typical) |
| | Response time | 8ms (Gray to Gray) |
| Display Colors | | Approx.1.07B |
| Sync Frequency | | Horizontal: 30.0-83.0kHz, Vertical: 50-76Hz |
| Native Resolution | | 3840 × 2160, 8.2 MegaPixels |
| Support Max. Resolution | | 3840 × 2160 |
| Input Connector | | HDMI×3, DisplayPort |
| Input Audio Connector | | mini jack |
| Input Component Connector | | RCA (YPbPr) |
| LAN | | RJ45 |
| Serial Port | | RS-232C In/Out |
| Plug & Play | | VESA DDC2B™ |
| Input Video Signal | | Digital: HDMI, DisplayPort |
| Input Audio Signal | | 0.5Vrms maximum |
| IR Extender Connector | | IR |
| USB Media player | | USB2.0×2, USB3.0×1 |
| Output Connector | | DisplayPort |
| Output Audio Connector | | RCA(L/R) |
| Speakers | | 10W×2 (Stereo speakers) |
| Maximum Screen Size | | 1428.48mm W × 843.33mm H / 56.2" W × 33.2" H |
| Power Source | | 100-240VAC, 50-60Hz, 1.8A |
| Power Consumption* | | 170W typical, Power management mode: 0.5W maximum Energy Efficiency Class: C |
| Dimensions / Net Weight | | 1462.5 × 843.5 × 70.0mm / 57.6 × 33.2 × 2.7" (W×H×D) 22.8kg / 50.2lbs |
| Environmental Considerations | | Operating: Temperature 0 to 40°C / 32 to 104°F Humidity 85% (No condensation) Storage: Temperature -20 to 60°C / 4 to 140°F Humidity 85% (No condensation) |
| Approvals | | CB, CE, CU, TÜV-Bauart |

NOTE * Audio equipment are not connected.

DIMENSIONS : ProLite LH5050UHS

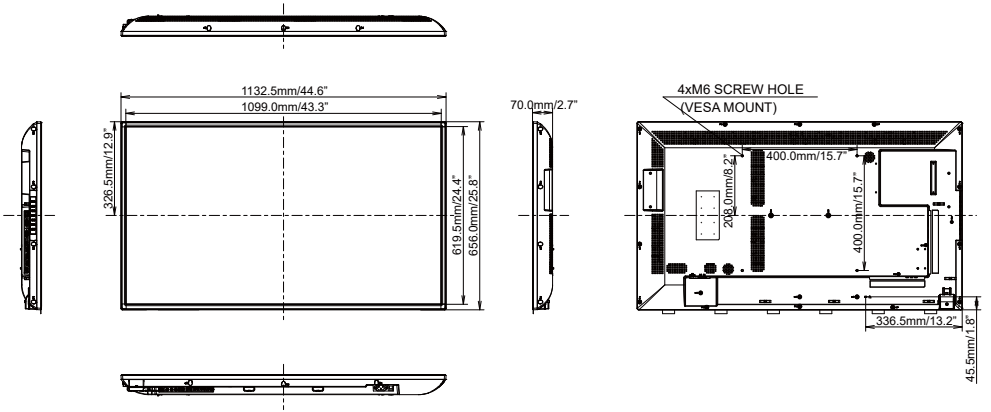

ENGLISH

DIMENSIONS : ProLite LH5550UHS

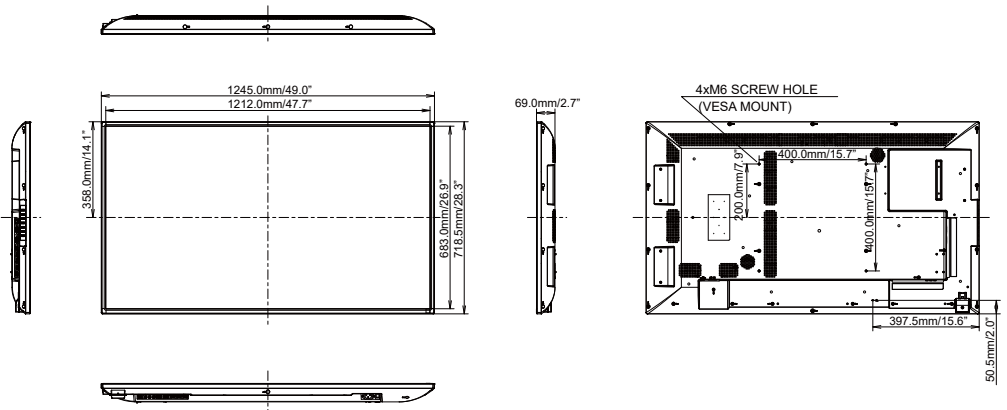

DIMENSIONS : ProLite LH6550UHS

ENGLISH

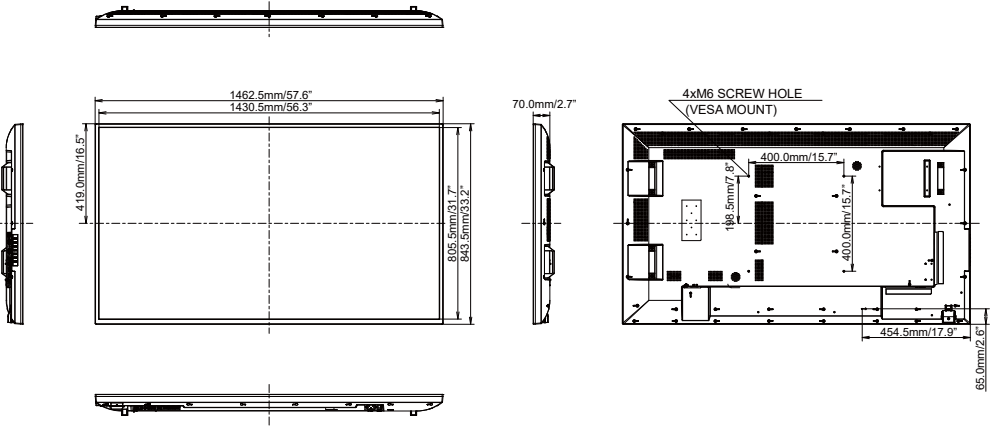

COMPLIANT TIMING

| Timing | | fH(kHz) | fV(Hz) | Dot clock (MHz) | HDMI1 | HDMI2 | HDMI3 | DisplayPort | YPbPr |
|--------|-----------------|---------|---------|-----------------|---------|-------|-------|-------------|-------|
| VESA | VGA 640x480 | 31.5 | 60.0 | 25.175 | ○ | ○ | ○ | ○ | |
| | SVGA 800x600 | 37.9 | 60.0 | 40.000 | ○ | ○ | ○ | ○ | |
| | XGA 1024x768 | 60.0 | 75.0 | 78.750 | ○ | ○ | ○ | ○ | |
| | SXGA 1280x1024 | 64.0 | 60.0 | 108.000 | ○ | ○ | ○ | ○ | |
| | CVT 1400x900 | 55.9 | 60.0 | 106.500 | ○ | ○ | ○ | ○ | |
| | WSXGA 1680x1050 | 65.3 | 60.0 | 146.250 | ○ | ○ | ○ | ○ | |
| | FHD 1920x1080 | 67.5 | 60.0 | 148.500 | ○ | ○ | ○ | ○ | |
| | 4K 3840x2160 | 54.0 | 24.0 | 297.000 | ○ | ○ | ○ | ○ | |
| | | 67.5 | 30.0 | 297.000 | ○ | ○ | ○ | ○ | |
| 112.5 | | 50.0 | 594.000 | ○ | ○ | ○ | ○ | | |
| 135.0 | | 60.0 | 594.000 | ○ | ○ | ○ | ○ | | |
| IBM | 720x400 | 31.5 | 70.0 | 28.320 | ○ | ○ | ○ | ○ | |
| SD | 480i | 60Hz | 15.7 | 60.0 | 27.000 | ○ | ○ | ○ | ○ |
| | 576i | 50Hz | 15.6 | 50.0 | 27.000 | ○ | ○ | ○ | ○ |
| | 480p | 60Hz | 31.5 | 60.0 | 27.000 | ○ | ○ | ○ | ○ |
| | 576p | 50Hz | 31.3 | 50.0 | 27.000 | ○ | ○ | ○ | ○ |
| HD | 720p | 50Hz | 37.5 | 50.0 | 74.250 | ○ | ○ | ○ | ○ |
| | | 60Hz | 45.0 | 60.0 | 74.250 | ○ | ○ | ○ | ○ |
| | 1080i | 50Hz | 28.1 | 50.0 | 74.250 | ○ | ○ | ○ | ○ |
| | | 60Hz | 33.8 | 60.0 | 74.250 | ○ | ○ | ○ | ○ |
| | 1080p | 50Hz | 56.3 | 50.0 | 148.500 | ○ | ○ | ○ | |
| | | 60Hz | 67.5 | 60.0 | 148.500 | ○ | ○ | ○ | |

* ○ means supported the timing.