

USER MANUAL

Pro Lite

LCD Monitor

ENGLISH

Pro Lite LE7540UHS
Pro Lite LE8640UHS

Thank you very much for choosing the iiyama LCD display for signage.
We recommend that you take a few minutes to read this comprehensive manual carefully before installing and switching on the display. Please keep this manual in a safe place for your future reference.



Dear user, we congratulate you on the purchase of your iiyama LCD.

For details on warranty and locally used pixel policies that apply directly after installation of your product please check the iiyama website.

To report a fault, please contact your local support centre found at www.iiyama.com/service

Things to check before you call the iiyama information line

- | if the power cable is connected securely and turned on?
- | if the display has been turned on?
- | if the signal cable is connected securely and the correct input selected?
- | if the computer has been restarted with the display connected?
- | if the graphics card is correctly installed with the latest drivers possible?
- | if the correct native resolution has been selected via 'Display Properties'?
- | If the R/G/B signal configuration is correct?
- | if the displays On Screen Menu is shown?
- | if the correct brightness and contrast settings have been set?
- | if given display tolerances and compatibility have been considered?
- | if via the On Screen Menu you have performed a Factory Reset/Recall?

Before reporting the screen defect, please prepare the following information/evidence:

- | model number *
- | purchase receipt and serial number *
- | name and address for collection
- | telephone/fax number, for availability during the day
- | convenient collection date (date, time)
- | short description of the defect

Important Note:

If there is no fault found in the collected equipment after inspection, the transferring party shall incur charges for transport and administration.

If you have checked all of the above and there is still no picture, call our information line for assistance in your country.

* see the identification plate on the back of the case.

CE MARKING DECLARATION OF CONFORMITY

This LCD display complies with the requirements of the EC/EU Directive 2014/30/EU "EMC Directive", 2014/35/EU "Low Voltage Directive" and 2011/65/EU "RoHS Directive".

Warning

This is a class A product. In a domestic environment this product may cause radio interference in which case the user may be required to take adequate measures.

IYAMA CORPORATION: Wijkemeerstraat 8, 2131 HA Hoofddorp, The Netherlands

Model No. : PL7540UH, PL8640UH



We recommend recycling of used product. Please contact your dealer or iiyama service center. Recycle information is obtained via the Internet, using the address: <http://www.iiyama.com>

You can access the Web page of different countries from there.

- We reserve the right to change specifications without notice.
- All trademarks used in this user manual are the property of their respective owners.

TABLE OF CONTENTS

FOR YOUR SAFETY.....	1
SAFETY PRECAUTIONS.....	1
SPECIAL NOTES ON LCD MONITORS.....	3
CUSTOMER SERVICE.....	5
CLEANING.....	5
BEFORE YOU OPERATE THE DISPLAY.....	6
FEATURES.....	6
CHECKING THE CONTENTS OF THE PACKAGE.....	6
UNPACKING.....	7
CONTROLS AND CONNECTORS : DISPLAY.....	8
INSTALLATION.....	11
CONTROLS AND CONNECTORS : REMOTE CONTROL.....	12
PREPARING THE REMOTE CONTROL.....	13
ID REMOTE CONTROL.....	14
BASIC OPERATION.....	15
CONNECTING YOUR THE DISPLAY : ProLite LE7540UHS.....	18
CONNECTING YOUR THE DISPLAY : ProLite LE8640UHS.....	19
COMPUTER SETTING.....	22
OPERATING THE DISPLAY.....	23
ADJUSTMENT MENU CONTENTS.....	25
SCREEN ADJUSTMENTS.....	42
POWER MANAGEMENT FEATURE.....	45
TROUBLE SHOOTING.....	46
RECYCLING INFORMATION.....	47
APPENDIX.....	48
SPECIFICATIONS : ProLite LE7540UHS.....	48
SPECIFICATIONS : ProLite LE8640UHS.....	49
DIMENSIONS : ProLite LE7540UHS.....	50
DIMENSIONS : ProLite LE8640UHS.....	50
COMPLIANT TIMING.....	51

FOR YOUR SAFETY

SAFETY PRECAUTIONS

WARNING

STOP OPERATING THE DISPLAY WHEN YOU SENSE TROUBLE

If you notice any abnormal phenomena such as smoke, strange sounds or fumes, unplug the display and contact your dealer or iiyama service center immediately. Further use may be dangerous and can cause fire or electric shock.

NEVER REMOVE THE CABINET

High voltage circuits are inside the display. Removing the cabinet may expose you to the danger of fire or electric shock.

DO NOT PUT ANY OBJECT INTO THE DISPLAY

Do not put any solid objects or liquids such as water into the display. In case of an accident, unplug your display immediately and contact your dealer or iiyama service center. Using the display with any object inside may cause fire, electric shock or damage.

INSTALL THE DISPLAY ON A FLAT, STABLE SURFACE

The display may cause an injury if it falls or is dropped.

DO NOT USE THE DISPLAY NEAR WATER

Do not use where water may be splashed or spilt onto the display as it may cause fire or electric shock.

OPERATE UNDER THE SPECIFIED POWER SUPPLY

Be sure to operate the display only with the specified power supply. Use of an incorrect voltage will cause malfunction and may cause fire or electric shock.

PROTECT THE CABLES

Do not pull or bend the power cable and signal cable. Do not place the display or any other heavy objects on the cables. If damaged, the cables may cause fire or electric shock.

ADVERSE WEATHER CONDITIONS

It is advisable not to operate the display during a heavy thunder storm as the continual breaks in power may cause malfunction. It is also advised not to touch the plug in these circumstances as it may cause electric shock.

CAUTION

INSTALLATION LOCATION

Do not install the display where sudden temperature changes may occur, or in humid, dusty or smoky areas as it may cause fire, electric shock or damage. You should also avoid areas where the sun shines directly on the display.

DO NOT PLACE THE DISPLAY IN A HAZARDOUS POSITION

The display may topple and cause injury if not suitably located. Please also ensure that you do not place any heavy objects on the display, and that all cables are routed such that children may not pull the cables and possibly cause injury.

MAINTAIN GOOD VENTILATION

Ventilation slots are provided to keep the display from overheating. Covering the slots may cause fire. To allow adequate air circulation, place the display at least 10 cm (or 4 inches) from any walls. Do not remove the tilt stand when operating the display. Ventilation slots on the back of the cabinet will be blocked and the display may overheat if the stand is removed. This may cause fire or damage. Operating the display on its back, side, upside down or on a carpet or any other soft material may also cause damage.

DISCONNECT THE CABLES WHEN YOU MOVE THE DISPLAY

When you move the display, turn off the power switch, unplug the display and be sure the signal cable is disconnected. If you do not disconnect them, it may cause fire or electric shock.

UNPLUG THE DISPLAY

If the display is not in use for a long period of time it is recommended that it is left unplugged to avoid accidents.

HOLD THE PLUG WHEN DISCONNECTING

To disconnect the power cable or signal cable, always pull it by the plug. Never pull on the cable itself as this may cause fire or electric shock.

DO NOT TOUCH THE PLUG WITH WET HANDS

Pulling or inserting the plug with wet hands may cause electric shock.

WHEN YOU INSTALL THE DISPLAY ON YOUR COMPUTER

Be sure the computer is strong enough to hold the weight of the display, otherwise, you may damage your computer.

REMARK FOR 24/7 USAGE

This product is not specifically designed for 24/7 usage. (Recommended operating time is 18 hours/Day.)

OTHERS

ERGONOMIC RECOMMENDATIONS

To eliminate eye fatigue, do not operate the display against a bright background or in a dark room. For optimal viewing comfort, the display should be just below eye level and 40-60 cm (16-24 inches) away from your eyes. When using the display over a prolonged time, a ten minute break every hour is recommended as looking at the screen continuously can cause eye strain.

SPECIAL NOTES ON LCD MONITORS

- The following symptoms are normal with LCD monitors and do not indicate a problem.

NOTE

- When you first turn on the LCD monitor, the picture may not fit in the display area because of the type of computer that is used. In this case, adjust the picture position to the correct position.
 - You may find slightly uneven brightness on the screen depending on the desktop pattern you use.
 - Due to the nature of the LCD screen, an afterimage of the previous screen may remain after switching the image, when the same image is displayed for hours. In this case, the screen is recovered slowly by changing the image or turning off the Power Switch for hours.
- This LCD cannot be used outdoors.
 - This LCD cannot be used with the screen facing upwards.
 - If you use a cable longer than the supplied one, the picture quality is not guaranteed.

USAGE CONFIRMATION

This product is designed for optimum usage at 18hours per day.
The display is compatible for usage in Landscape applications.

IMAGE PERSISTENCE / IMAGE STICKING

Please be aware that all LCD screens can experience Image Persistence or Image Sticking. This occurs when a residual image remains visible on a screen when static images are displayed for long periods of time. LCD Image Persistence is not permanent but constant images being displayed for a long period of time should be avoided.

To counteract Image Persistence, turn off the monitor for as long as the previous image was displayed, so if an image was on the monitor for 1 hour and there is evidence of a residual or “ghost” image, you should turn off the monitor for 1 hour in order to clear the residual image.

For all LFD products, iiyama recommends displaying moving images and utilising a moving screen saver at regular intervals whenever the screen is idle. You could also turn off the monitor when not in use to assist the prevention.

Other ways to reduce the risk of Image Persistence will be to utilise the FAN-on function (if available), Low Backlight and Low Brightness settings.

FOR EXTENDED USE AS A PUBLIC DISPLAY

■ Image Sticking on LCD Panel

When a static image is displayed for hours, an electric charge trace remains near the electrode inside the LCD producing a “ghost” image. (Image Persistence).

Image Persistence is not a permanent feature.

■ Recommendations

To prevent Image Sticking and promote longer life expectancy of display, we recommend the following:

1. Avoid static images displayed for long periods – change static images on continuous loop.
2. Turn off monitor when not in use, either by remote control or use Power Management or Schedule functions.
3. When monitor is installed in high ambient temperature environment(s) or in an enclosed position, utilise the Cooling Fan, Screen Saver and Low Brightness functions.
4. Suitable ventilation for any monitor is an expectation of any installation – climate control systems may need to be employed.
5. We strongly recommend utilisation of active cooling with fans for long operation times or high ambient temperature environments.

CUSTOMER SERVICE

NOTE

- If you have to return your unit for service and the original packaging has been discarded, please contact your dealer or iiyama service center for advice or replacement packaging.

CLEANING

WARNING

- If you drop any materials or liquids such as water into the display when cleaning, unplug the power cable immediately and contact your dealer or iiyama service center.

CAUTION

- For safety reasons, turn off the power switch and unplug the display before you clean it.

NOTE

- To protect the LCD panel, do not scratch or rub the screen with a hard object.
- Never use any of the following strong solvents. These will damage the cabinet and the LCD screen.

Thinner	Benzine	Abrasive cleaner
Spray-type cleaner	Wax	Acid or Alkaline solvent

- Touching the cabinet with any product made from rubber or plastic for a long time may cause degeneration or loss of paint on the cabinet.

CABINET

Stains can be removed with a cloth lightly moistened with a mild detergent solvent. Then wipe the cabinet with a soft dry cloth.

LCD

Periodic cleaning with a soft dry cloth is recommended.

SCREEN

Don't use tissue paper etc. because these will damage the LCD screen.

BEFORE YOU OPERATE THE DISPLAY

FEATURES

- ◆ Supports Resolutions up to 3840 × 2160
- ◆ High Contrast 1200:1 (Typical) / Brightness 410cd/m² (Typical)
- ◆ Digital Character Smoothing
- ◆ Automatic Set-up
- ◆ Stereo Speakers
2 × 10W Stereo Speakers
- ◆ Plug & Play VESA DDC2B Compliant
Windows[®] XP/Vista/7/8/8.1/10 Compliant
- ◆ Power Management (VESA DPMS Compliant)
- ◆ VESA Mounting Standard (600mm×400mm) Compliant

CHECKING THE CONTENTS OF THE PACKAGE

The following accessories are included in your package. Check to see if they are enclosed with the display. If anything is missing or damaged, please contact your local iiyama dealer or regional iiyama office.

- | | | |
|---------------------|-----------------|-----------------------|
| ■ Power Cable* | ■ HDMI Cable | ■ mDP-DP Cable |
| ■ DisplayPort Cable | ■ RS-232C Cable | ■ Remote Control |
| ■ Battery (2pcs) | ■ POP Label | ■ iiyama Logo Sticker |
| ■ EU Energy Label | ■ Safety Guide | ■ Quick Start Guide |

CAUTION

- * The rating of the Power Cable enclosed in 120V area is 10A/125V. If you are using a power supply higher than this rating, then a power cable with a rating of 10A/250V must be used. However, all guarantees and warranties are void for any problems or damage caused by a power cable not supplied by iiyama.
An approved power cord greater or equal to H05VVf, 3G, 0.75mm² must be used.

UNPACKING

- ① Before unpacking your display, prepare a stable, level, and clean surface near a wall outlet. Set the LCD display box in an upright position and open from the top of the box before removing the top cushions.
- ② Remove the carton holders.
- ③ Remove the top cushion and take the accessories box and the display out.

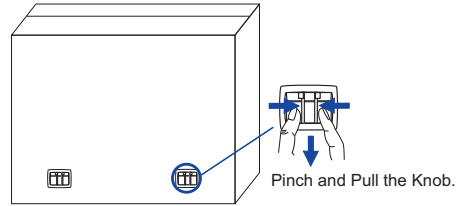

CAUTION

Moving the display requires at least two people. If not, it may drop and could result in a serious injury.

CONTROLS AND CONNECTORS : DISPLAY

<Back Controller>

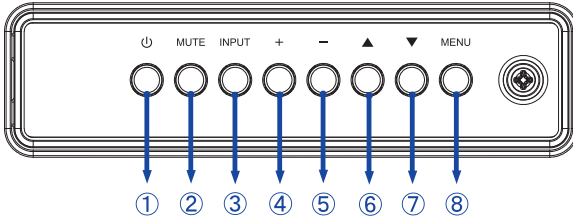

①		Power Button
②	MUTE	Mute Button
③	INPUT	Enter / Input Select Button
④	+	+ Button
⑤	-	- Button
⑥	▲	Up Button
⑦	▼	Down Button
⑧	MENU	Menu Button

<Front>



<Remote sensor and power indicator - location>

1. Pull down the lens to improve remote control performance and ensure good visibility of the power status diode.
2. Push up the lens before mounting the display for video wall application.
3. Pull/Push the lens until hearing the click sound.

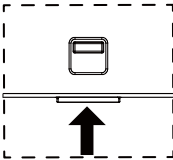

Push up to hide the lens

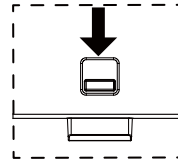

Push down to extend the lens

⑨	Power Indicator	Green	Lighting : Normal Operation
		Red	If turn off the Power Button on the Remote Control and the Back Controller. Power Management
		Green & Red	Flash : When SCHEDULE is enabled.
		Off	Power Off
⑩	Remote Sensor		Remote Sensor

■ ProLite LE7540UHS

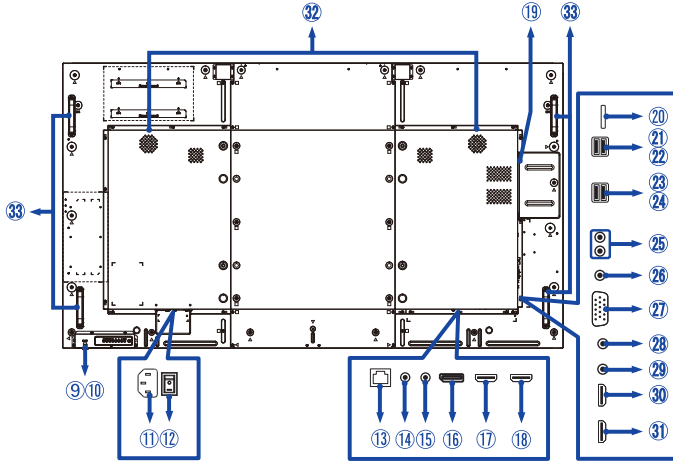

■ ProLite LE8640UHS

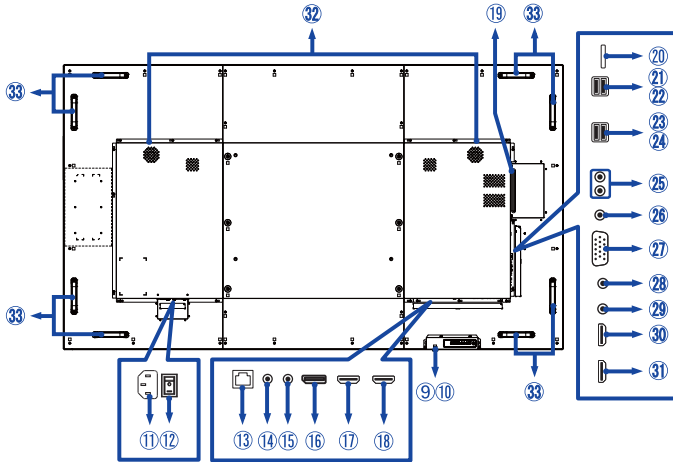

⑪	AC IN	AC-INLET	AC Connector(~ : Alternating current) (AC-IN)
⑫	AC SWITCH (ON) / ○ (OFF)	MAIN POWER	Main Power Switch
⑬	LAN	RJ45	RJ45 Connector
⑭	RS232C IN	Mini Jack	RS232C Connector
⑮	RS232C OUT	Mini Jack	RS232C Connector
⑯	DisplayPort IN	DisplayPort	DisplayPort Connector
⑰	HDMI1 IN	HDMI	HDMI Connector
⑱	HDMI2 IN	HDMI	HDMI Connector
⑲	Option Slot (Card OPS)		Option Slot
⑳	MICRO SD		Micro SD slot
㉑	USB	5V0.5A	USB Connector
㉒	USB	5V2A USB power charging	USB Connector
㉓	USB	USB2.0	USB Connector
㉔	USB	USB3.0	USB Connector
㉕	AUDIO OUT	RCA L/R	Audio output Connector
㉖	AUDIO IN	Mini Jack	Audio Connector
㉗	VGA IN	VGA	VGA Connector
㉘	IR IN	IR	IR Connector
㉙	IR OUT	IR	IR Connector
㉚	HDMI4 IN	HDMI	HDMI Connector
㉛	HDMI3 IN	HDMI	HDMI Connector
㉜	Speakers		Speakers
㉝	Handles		Handles

INSTALLATION

CAUTION

- Follow the manual instructions for the type of mount you have selected. Refer all servicing to qualified service personnel.
- Moving the display requires at least two people.
- Before installing, please make sure the wall is strong enough to hold the necessary weight of the display and the mount.

[WALL MOUNTING]

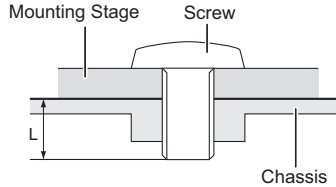

CAUTION

When using the wall mounting, consideration of thickness of the mounting stage needs to be taken. Tighten the M6 Screw with washer which "L" length is 10mm to fasten the display. Using a screw longer than this may cause electric shock or damage because it may contact with the electrical parts inside the display.

[ROTATING THE DISPLAY]

It is designed to be compatible in landscape mode.

Available



Power indicator

Not Available



CONTROLS AND CONNECTORS : REMOTE CONTROL

ENGLISH

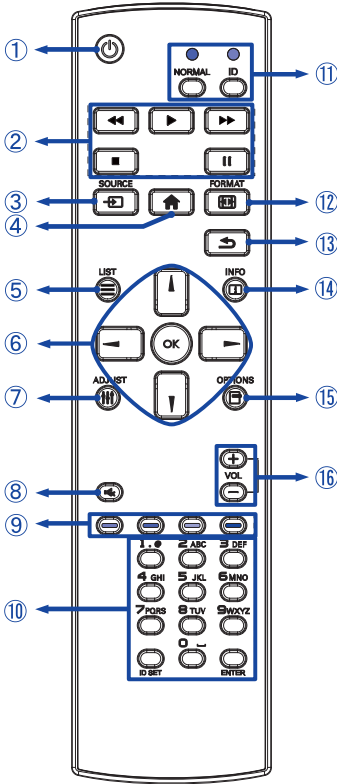

①		Turns the display ON and OFF.
②	[PLAY]	Control playback of media files. ▶ : Play ■ : Stop ⏸ : Pause ◀◀ : Quick-Return ▶▶ : Fast-Forward
③	SOURCE	Selects the source. Press ▲ or ▼ button to select from HDMI1, HDMI2, HDMI3, HDMI4, DisplayPort, VGA, OPS, Mediaplayer, Browser, CMS, PDF player or Custom. Press [OK] button to confirm and exit.
④		Opens the display's on-screen menu systems.
⑤	LIST	Not available on this model.
⑥		Navigates through submenus and settings. ▲ : Up Button ▼ : Down Button ◀ : Left Button ▶ : Right Button
	OK	Confirms your selection or save changes.
⑦		Auto Adjust function only available when VGA input is selected.
⑧		Turns on or off the mute function when the Menu is not displayed.
⑨		Select tasks or options.
⑩	NUMBER/ ID SET/ENTER	Enter text for network setting.
⑪	ID Mode	ID: To enter ID Mode NORMAL: To leave ID Mode
⑫		Change picture format.
⑬		Returns to a previous menu or closes the OSD Menu.
⑭		Provides source and resolution information.
⑮		Not available on this model.
⑯	VOLUME - / +	VOLUME-: Decreases the sound volume. VOLUME+: Increases the sound volume.

PREPARING THE REMOTE CONTROL

To use the remote control, insert the two dry batteries.

CAUTION

Do not use any other batteries other than those specified in this manual for the Remote Control. Do not insert old and new batteries together in the Remote Control. Make sure that the terminals match the "+" and "-" indications in the battery compartment. Burst batteries or the electrolyte from these batteries may cause stains, fire or injury.

- ① Press and then slide the battery cover to open it.

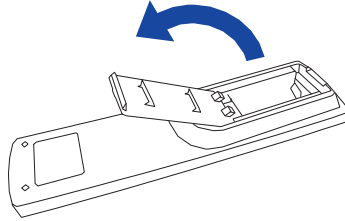

- ② Align and insert two AAA batteries according to their plus and minus ports (as indicated in the remote control).

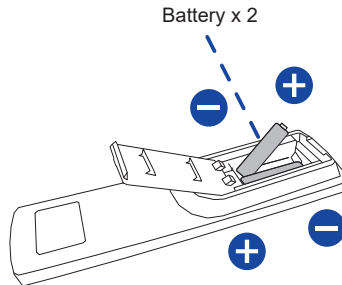

- ③ Replace the battery cover.

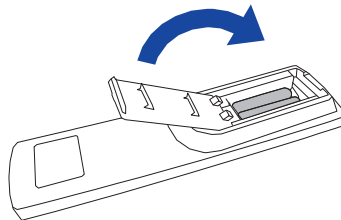

NOTE

- Replace with new batteries when the Remote Control does not work close to the display. Use AAA dry batteries.
- Operate the Remote Control by pointing it toward the Remote Sensor on the display.
- Other manufacturers remote control will not work with this display. Use the provided Remote Control ONLY.
- Used batteries needed to follow the local rules to be discarded. (Suggestion: to dispose of used batteries please follow correct policy as per your local regulations.)

ID REMOTE CONTROL

You can set the remote control ID when you want to use the remote control on specific monitors.

ID Mode (To enter ID Mode) : Press and hold the ID button until the red LED blinks twice.

Normal Mode (To leave ID Mode) : Press and hold the Normal button until the green LED blinks twice.

■ Programming ID Mode

To assign an ID to a remote control.

1. Enter ID Mode.
2. Press and hold the ID SET button until the red LED turned on.
3. Using the number button, input the desired ID. (01 - 255)
4. Press the ENTER button to confirm ID.
5. The red LED will blink twice when ID has been confirmed.
6. Press the ID SET button will exit the ID Mode. The LED lights off.

NOTE

- Not pressing any button within 10 seconds will exit the ID Mode.
- If an error pressing of buttons other than the digits occurred, wait 1 second after the red LED lights off and then lights up again, then press the correct digits again.
- To cancel or stop programming an ID, press the ID SET button.
- It is necessary to set up the ID number for each monitor before selecting its ID number.

■ Use ID Mode

1. Enter ID Mode.
2. Input the ID of the monitor which would like to control by number button.
3. Press the ENTER button.

BASIC OPERATION

■ Turning the display ON

The display is turned On and the Power Indicator turns to Green when you press the POWER button on the display or the Remote Control. The display is turned Off and the Power Indicator turns to Red when you press the POWER button on the display or the Remote Control. Press again to turn On the display.

NOTE

Even when using the power management mode or turning OFF the Power Switch, the display will consume a small amount of electricity. Disconnect the Power Cable from the power supply whenever the display is not in use or during the night, to avoid unnecessary power consumption.

[Display]

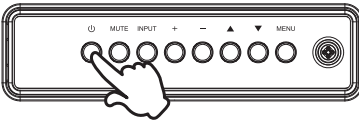

[Remote Control]

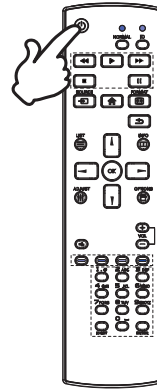

■ Display the adjustment menu page

The menu page appears on the screen when you press the MENU button on the display or the  HOME button on the Remote Control.

The menu page disappears when you press the  BACK button on the Remote Control again.

[Display]

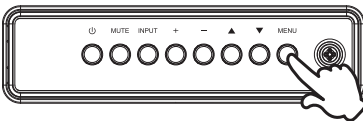

[Remote Control]

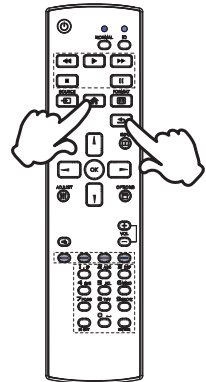

■ Move the cursor vertically

Select adjustment by pressing the ▲ / ▼ button on the display or the ▲ / ▼ button on the remote control while the menu page is displayed on the screen.

[Display]

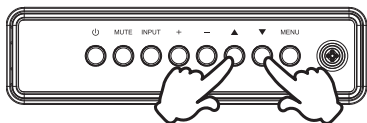

[Remote Control]

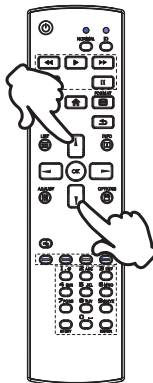

■ Move the cursor horizontally

Select menu or setting, or perform the adjustment by pressing the + / - button on the display or the ◀ / ▶ button on the remote control while the menu page is displayed on the screen.

[Display]

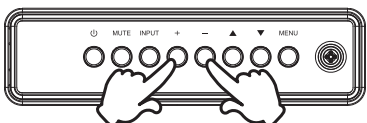

[Remote Control]

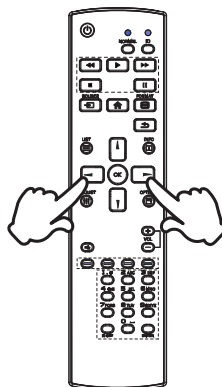

■ Adjust the volume of sound

Press the + / - button on the display or the remote control to adjust the volume of sound when the menu page is not displayed on the screen.

[Display]

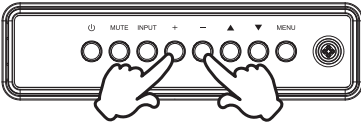

[Remote Control]

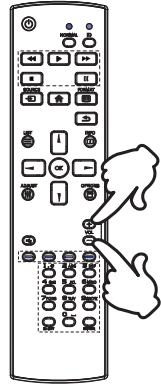

■ Switch the input signal

This is activated when you successively press the INPUT button on the display or the SOURCE button on the remote control.

[Display]

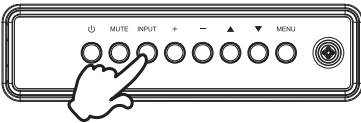

[Remote Control]

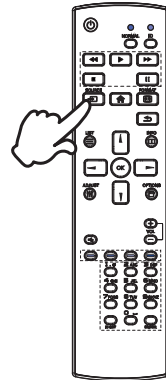

CONNECTING YOUR THE DISPLAY : ProLite LE7540UHS

- ① Ensure that both the computer and the display are switched off.
- ② Connect the computer to the display with the signal cable.
- ③ Connect the computer with the RS-232C Cable from the Display.
- ④ Connect the Power Cable to the display first and then to the power supply.
- ⑤ Turn on your display (Main Power Switch and Power Switch) and computer.

NOTE

- The signal cables used for connecting the computer and display may vary with the type of computer used. An incorrect connection may cause serious damage to both the display and the computer. The cable supplied with the display is for a standard connector. If a special cable is required please contact your local iiyama dealer or regional iiyama office.
- For connection to Macintosh computers, contact your local iiyama dealer or regional iiyama office for a suitable adaptor.
- Make sure you tighten the finger screws at each end of the Signal Cable.
- The Class I pluggable equipment Type A must be connected to protective earth.
- The socket-outlet shall be installed near the equipment and shall be easily accessible.

[Example of Connection]

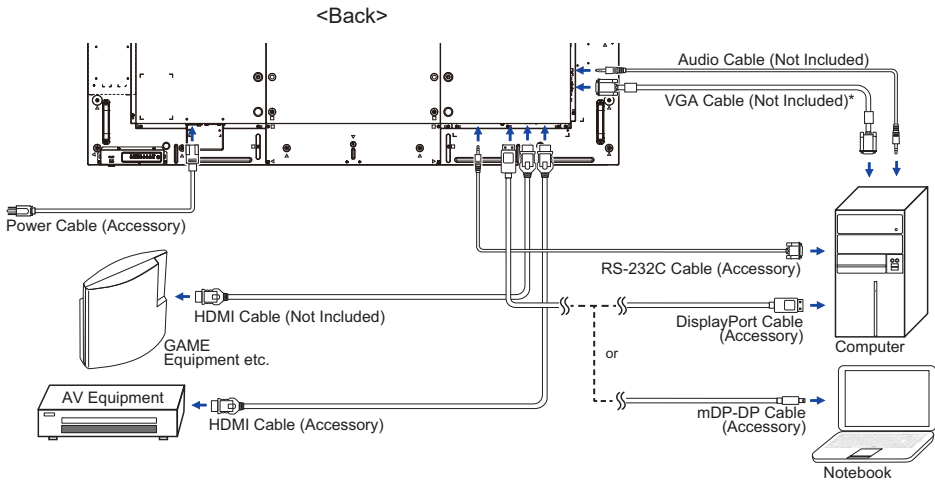

* VGA cable is not supplied with the display. If you use low quality VGA cable, it may cause a result of electro-magnetic interference. Please contact the iiyama Support Centre in your country if you wish to connect the display via the VGA input.

CONNECTING YOUR THE DISPLAY : ProLite LE8640UHS

- ① Ensure that both the computer and the display are switched off.
- ② Connect the computer to the display with the signal cable.
- ③ Connect the computer with the RS-232C Cable from the Display.
- ④ Connect the Power Cable to the display first and then to the power supply.
- ⑤ Turn on your display (Main Power Switch and Power Switch) and computer.

NOTE

- The signal cables used for connecting the computer and display may vary with the type of computer used. An incorrect connection may cause serious damage to both the display and the computer. The cable supplied with the display is for a standard connector. If a special cable is required please contact your local iiyama dealer or regional iiyama office.
- For connection to Macintosh computers, contact your local iiyama dealer or regional iiyama office for a suitable adaptor.
- Make sure you tighten the finger screws at each end of the Signal Cable.
- The Class I pluggable equipment Type A must be connected to protective earth.
- The socket-outlet shall be installed near the equipment and shall be easily accessible.

[Example of Connection]

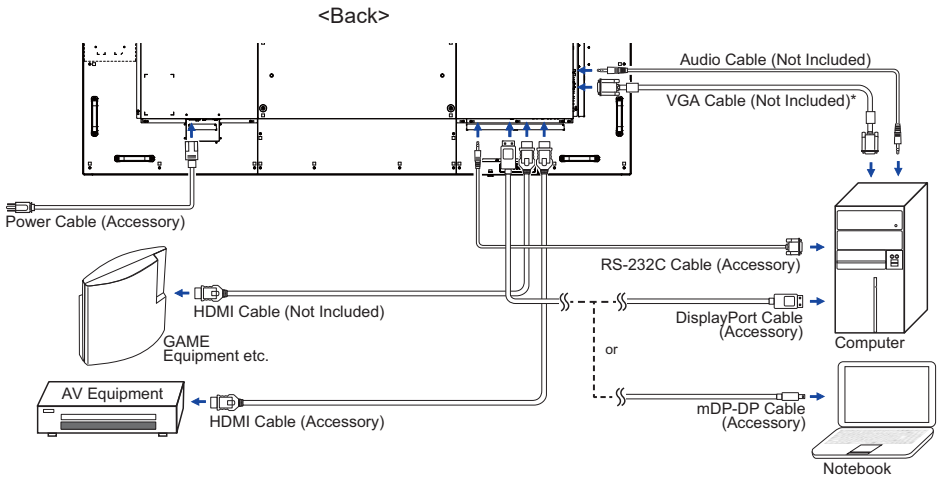

* VGA cable is not supplied with the display. If you use low quality VGA cable, it may cause a result of electro-magnetic interference. Please contact the iiyama Support Centre in your country if you wish to connect the display via the VGA input.

[Connection example with the peripheral device]

CAUTION

Turn off the power switch and unplug the display and peripherals before connection to avoid electric shock or damage.

NOTE

- Refer to the user manual of peripherals at the same time.
- Ensure you have the necessary cables as required.

■ ProLite LE7540UHS

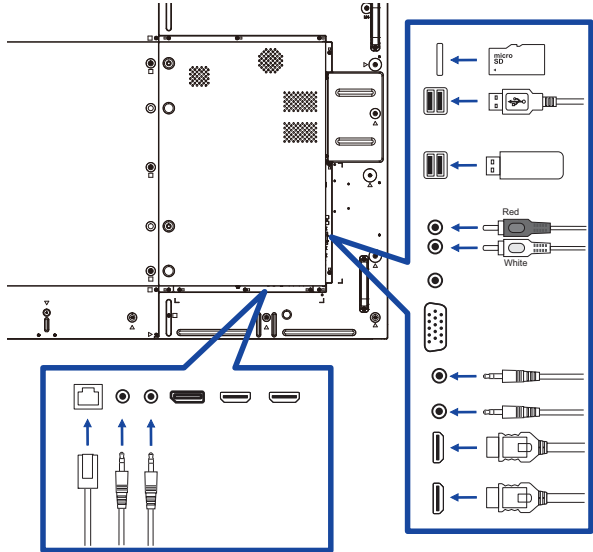

■ ProLite LE8640UHS

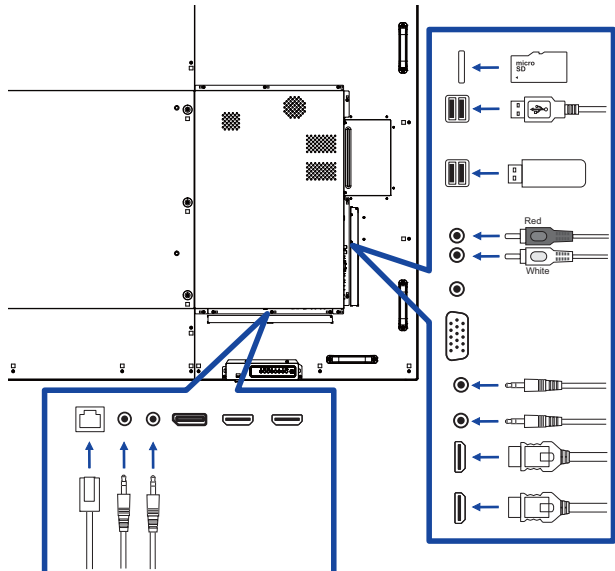

[About the daisy chain]

■ Monitor control connection

RS-232C

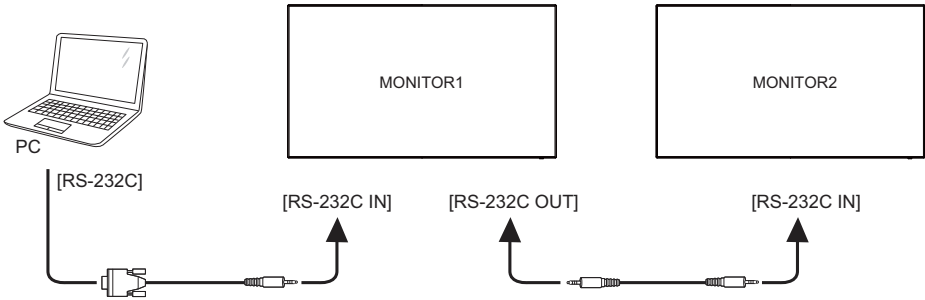

[To setup the network]

1. Switch on the router and switch on its DHCP setting.
2. Connect the router to this display with an Ethernet cable.
3. Press  HOME button on the remote control, then select Setup.
4. Select "Connect to network", then press OK button.
5. Follow the on-screen instructions to install the network.
6. Wait for this display to find the network connection.
7. If you are prompted, agree to the "End User Licence Agreement".

NOTE Connecting with a shielded CAT-5 Ethernet cable to comply with the EMC directive.

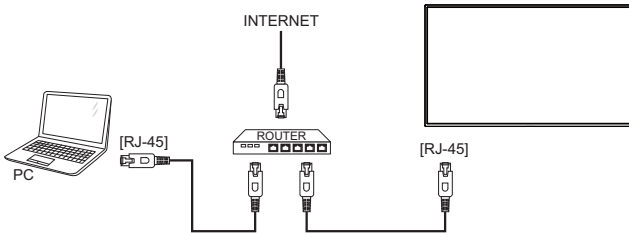

COMPUTER SETTING

■ Signal Timing

Change to the desired signal timing listed on page 51: COMPLIANT TIMING.

■ Windows XP/Vista/7/8/8.1/10 Plug & Play

The iiyama LCD display complies with DDC2B of VESA standard. The Plug & Play function runs on Windows XP/Vista/7/8/8.1/10 by connecting the display to DDC2B compliant computer with the Signal Cable supplied.

For installation on Windows XP: The display Information File for iiyama displays may be necessary for your computer and obtained via the Internet, using the address:

<http://www.iiyama.com>

NOTE

- Display Drivers are not required in most cases for Macintosh or Unix operating systems. For further information, please contact your computer dealer first for advice.

■ Procedure for turning ON the Power Switch

Turn ON the display first, and then the computer.

OPERATING THE DISPLAY

To create the best picture, your iiyama LCD display has been preset at the factory with the COMPLIANT TIMING shown on page 51. You are also able to adjust the picture by following the button operation shown below. For more detailed adjustments, see page 42 for SCREEN ADJUSTMENTS.

- 1 Press the **HOME** button on the remote control or the **MENU** button on the Display to start the On Screen Display feature. There are additional Menu items which can be switched by using the **▲ / ▼** buttons on the remote control or the **▲ / ▼** buttons on the display.

Picture	Brightness	90
Screen	Contrast	50
Audio	Sharpness	20
Configuration1	Black level	50
Configuration2	Tint	50
Advanced option	Color	55
	Noise reduction	Medium
	Gamma selection	Native
	Color temperature	Native
	Color control	Action
	Smart power	Off
	OverScan	Off

- 2 Select the Menu item of the adjustment you want to make. Press the **OK** button on the remote control or the **+** button on the display and enter the menu page. Then, use the **▲ / ▼** buttons on the remote control or the **▲ / ▼** buttons on the display to highlight the desired adjustment item.
- 3 Press the **OK** button on the remote control or the **+** button on the display again. Use the **◀ / ▶** buttons on the remote control or the **+ / -** buttons on the display to make the appropriate adjustment or setting.
- 4 Press the **BACK** button on the remote control or the **MENU** button on the display to leave the menu, and the settings you just made would be automatically saved.

For example, to correct for vertical position, select Menu item of "Screen". Press the **OK** button on the remote control or the **+** button on the display. Then, select "V. Position" by using the **▲ / ▼** buttons on the remote control or the **▲ / ▼** buttons on the display.

Picture	H position	
Screen	V position	
Audio	Clock	
Configuration1	Clock Phase	
Configuration2	Zoom mode	Full
Advanced option	Custom zoom	Action
	Auto adjust	Action
	Screen reset	Action

Use the **◀ / ▶** buttons on the remote control or the **+ / -** buttons on the display to change the vertical position settings. The vertical position of the overall display should be changing accordingly while you are doing this.



Press the **BACK** button on the remote control or the **MENU** button on the display lastly, it ends, all changes are saved in the memory.

NOTE

























- The  BACK button on the remote control or the + button on the display can be used to return previous menu item.
- Any changes are automatically saved in the memory when the On Screen Display disappears. Turning off the power should be avoided while using the Menu.
- Adjustments for H./V. Position, Clock and Phase are saved for each signal timing. Except for these adjustments, all other adjustments have only one setting which applies to all signal timings.

Direct * Available for Remote Control only.

You can skip the Menu items and display an adjustment scale directly by using the following button operations.

- **Auto Adjust:**
Press the ADJUST Button when the Menu is not displayed.
- **Zoom mode:**
Press the FORMAT Button when the Menu is not displayed.

ADJUSTMENT MENU CONTENTS

Picture																																					
<table border="1"> <thead> <tr> <th>Picture</th> <th>Brightness</th> <th>90</th> </tr> </thead> <tbody> <tr> <td>Screen</td> <td>Contrast</td> <td>50</td> </tr> <tr> <td>Audio</td> <td>Sharpness</td> <td>20</td> </tr> <tr> <td>Configuration1</td> <td>Black level</td> <td>50</td> </tr> <tr> <td>Configuration2</td> <td>Tint</td> <td>50</td> </tr> <tr> <td>Advanced option</td> <td>Color</td> <td>55</td> </tr> <tr> <td></td> <td>Noise reduction</td> <td>Medium</td> </tr> <tr> <td></td> <td>Gamma selection</td> <td>Native</td> </tr> <tr> <td></td> <td>Color temperature</td> <td>Native</td> </tr> <tr> <td></td> <td>Color control</td> <td>Action</td> </tr> <tr> <td></td> <td>Smart power</td> <td>Off</td> </tr> <tr> <td></td> <td>Custom</td> <td>Off</td> </tr> </tbody> </table>		Picture	Brightness	90	Screen	Contrast	50	Audio	Sharpness	20	Configuration1	Black level	50	Configuration2	Tint	50	Advanced option	Color	55		Noise reduction	Medium		Gamma selection	Native		Color temperature	Native		Color control	Action		Smart power	Off		Custom	Off
Picture	Brightness	90																																			
Screen	Contrast	50																																			
Audio	Sharpness	20																																			
Configuration1	Black level	50																																			
Configuration2	Tint	50																																			
Advanced option	Color	55																																			
	Noise reduction	Medium																																			
	Gamma selection	Native																																			
	Color temperature	Native																																			
	Color control	Action																																			
	Smart power	Off																																			
	Custom	Off																																			
Adjustment Item	Problem / Option	Button to Press																																			
Brightness* ¹	Too dark Too bright	   																																			
Contrast	Too dull Too intense	   																																			
Sharpness* ²	Too soft Too sharp	   																																			
Black level	Black is too dark Black is too bright	   																																			
Tint	Purplish Greenish	   																																			
Color	Too weak Too strong	   																																			
Noise reduction* ²	Off	Noise Reduction is turned off.																																			
	Low	Electronic image noise caused by different media players is reduced.																																			
	Medium	Electronic image noise caused by different media players is reduced more than Low.																																			
	High	Electronic image noise caused by different media players is reduced more than Medium.																																			
Gamma selection* ³	You can set the Gamma. Native / 2.2 / 2.4 / s gamma / D-image																																				
Color temperature	6500 ° K	Reddish white																																			
	7500 ° K	Greenish white																																			
	9300 ° K	Bluish white																																			
	10000 ° K	More bluish white																																			
	Native	Original color temperature																																			
	User1	User preset																																			
User2	User preset																																				



*¹ Adjust the Brightness when you are using the display in a dark room and feel the screen is too bright. Brightness adjustment is disabled when Brightness of Panel saving is on.

*² Only HDMI(Video) input.

*³ Press ▼ to display the options.

Picture

Picture	Contrast	50
Screen	Sharpness	20
Audio	Black level	50
Configuration1	Tint	50
Configuration2	Color	55
Advanced option	Noise reduction	Medium
	Gamma selection	Native
	Color temperature	Native
	Color control	Action
	Smart power	Off
	Overscan	Off
	Picture reset	Action

Adjustment Item	Problem / Option		Button to Press
Color control	Set user color.		
	User-R	Too weak Too strong	 
	User-G		
	User-B		
Smart power	Off	Normal	
	Midium	Brightness of back-light is reduced. (80%)	
	High	Brightness of back-light is reduced more than Midium. (65%)	
Over scan	Off	Over scan is turned off.	
	On	Display area about 95%.	
Picture reset	Cancel	Return to Menu.	
	Reset	Picture setting will be restored to factory-preset data.	

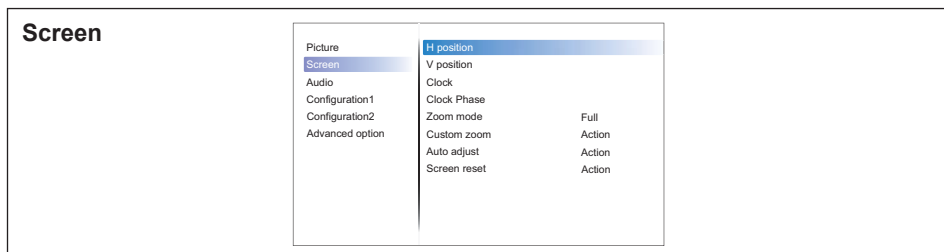

Adjustment Item	Problem / Option		Button to Press
H Position* ¹		Too left	
		Too right	
V Position* ¹		Too low	
		Too high	
Clock* ^{1,5}		Too narrow	
		Too wide	
Clock Phase* ^{1,5}	To correct flickering text or lines		
Zoom mode	Full* ^{2,3}	Enlarge the picture horizontally to fill the screen if the picture source is 4:3 (standard definition). When the picture source is 16:9 (high definition), it is not scaled.	
	4:3* ^{2,3}	Display all pictures in 4:3 aspect ratio.	
	Real* ^{2,3}	Display the picture dot by dot.	
	21:9* ^{2,3}	Display all pictures in 21:9 aspect ratio.	
	Custom* ²	Customize Zoom mode.	
Custom zoom* ^{2,4}	Zoom	Zoom the horizontal and vertical size of the image simultaneously.	
	H zoom	Zoom the horizontal size of the image.	
	V zoom	Zoom the vertical size of the image.	
Auto adjust* ^{1,6}	Adjust Position, Clock and Clock Phase automatically.		
Screen reset	Cancel	Return to Menu.	
	Reset	Screen setting will be restored to factory-preset data.	

*¹ Only VGA input.

*² Only VGA and HDMI inputs.

*³ Only Mediaplayer input.

























*⁴ Custom zoom is disabled when Pixel shift is enabled.

*⁵ See page 42 for SCREEN ADJUSTMENTS.

*⁶ For best results, use the Auto Adjust in conjunction with the adjustment pattern.
See page 42 for SCREEN ADJUSTMENTS.

Audio

Picture	Balance	50
Screen	Treble	50
Audio	Bass	50
Configuration1	Volume	20
Configuration2	Audio out (line out)	20
Advanced option	Maximum volume	100
	Minimum volume	0
	Mute	Off
	Audio source	Digital
	Audio reset	Action
	Audio Out Sync	Off

Adjustment Item	Problem / Option		Button to Press
Balance	Left side speaker is louder. Right side speaker is louder.		   
Treble	Too weak Too strong		   
Bass	Too weak Too strong		   
Volume	Too soft Too loud		   
Audio out (line out)	Adjust audio output volume. Too soft Too loud		   
Maximum volume	Set the maximum volume.		 
Minimum volume	Set the minimum volume.		 
Mute	Off	Return the sound volume to the previous level.	
	On	Turn off the sound temporarily.	
Audio Source	Analog	Select the VGA input.	
	Digital	Select the HDMI/DisplayPort input.	
Audio reset	Cancel	Return to Menu.	
	Reset	Audio setting will be restored to factory-preset data.	
Audio out sync	Off	Disable audio out (line out) volume.	
	On	Enable audio out (line out) volume.	

Adjustment Item		Problem / Option		Button to Press																								
<div style="border: 1px solid black; padding: 5px; margin-bottom: 10px;"> <table border="1" style="width: 100%; border-collapse: collapse;"> <tr> <td style="width: 33%;">Picture</td> <td style="width: 33%;">Switch on state</td> <td style="width: 33%;">Force on</td> </tr> <tr> <td>Screen</td> <td>Panel saving</td> <td>Action</td> </tr> <tr> <td>Audio</td> <td>RS232 routing</td> <td>RS232</td> </tr> <tr> <td style="background-color: #e0e0e0;">Configuration1</td> <td>Boot on source</td> <td>Action</td> </tr> <tr> <td>Configuration2</td> <td>WOL</td> <td>Off</td> </tr> <tr> <td>Advanced option</td> <td>RGB range</td> <td>Auto</td> </tr> <tr> <td></td> <td>Configuration1 reset</td> <td>Action</td> </tr> <tr> <td></td> <td>Factory reset</td> <td>Action</td> </tr> </table> </div>					Picture	Switch on state	Force on	Screen	Panel saving	Action	Audio	RS232 routing	RS232	Configuration1	Boot on source	Action	Configuration2	WOL	Off	Advanced option	RGB range	Auto		Configuration1 reset	Action		Factory reset	Action
Picture	Switch on state	Force on																										
Screen	Panel saving	Action																										
Audio	RS232 routing	RS232																										
Configuration1	Boot on source	Action																										
Configuration2	WOL	Off																										
Advanced option	RGB range	Auto																										
	Configuration1 reset	Action																										
	Factory reset	Action																										
Switch on state	Power off	The display will remain off when the power cord is connected to a wall outlet.																										
	Forced on	The display will turn on when the power cord is connected to a wall outlet.																										
	Last status	The display will return to the previous power status (on/off/standby) when removing and replacing the power cord.																										
Panel saving	Brightness	Off	Brightness is turned off.																									
		On	The image brightness will be reduced to an appropriate level.																									
	Pixel shift*1	For the display to slightly expand the image size and shift the position of pixels in four directions (up, down, left or right).																										
		Off	Pixel shift is turned off.																									
		Auto	Move the position of the image automatically.																									
0-80	Move the position of the image at set intervals.																											
RS232-routing	Select the network control port. RS232 / LAN → RS232 / OPS RS232*4																											
Boot on source*2,3	Last input	When the power is turned on, it starts with the same setting as when the power was last turned off. Disable / Enable																										
	Input	Select input source when boot up. HDMI1 / HDMI2 / HDMI3 / HDMI4 / DisplayPort / VGA / OPS*4 / Mediaplayer / Browser / CMS / PDF player / Custom																										
	Playlist	Select playlist index for Mediaplayer, Browser and PDF player.																										
WOL	Off	WOL is turned off.																										
	On	Turn the display on remotely over LAN network.																										
RGB range	Auto	Set color scale signal automatically.																										
	Full range	For full-range color scale signal.																										
	Limited range	For limited color scale signal.																										

*1 Only VGA and HDMI input.

*2 No failover function, system will keep source even the source is no signal input.

*3 Press ▼ to display the options.

*4 It can be used only when OPS is installed.













Configuration1

Picture	Switch on state	Force on
Screen	Panel saving	Action
Audio	RS232 routing	RS232
Configuration1	Boot on source	Action
Configuration2	WOL	Off
Advanced option	RGB range	Auto
	Configuration1 reset	Action
	Factory reset	Action

Adjustment Item	Problem / Option		Button to Press
Configuration1 reset	Cancel	Return to Menu.	
	Reset	Configuration1 setting will be restored to factory-preset data.	
Factory reset	Cancel	Return to Menu.	
	Reset	Factory-preset data is restored.	

Configuration2

Picture	OSD turn off	115
Screen	OSD H position	50
Audio	OSD V position	50
Configuration1	Information OSD	10
Configuration2	Logo	On
Advanced option	Monitor ID	Action
	Heat status	22,53°C 72,55°F
	Monitor information	Action
	HDMI Version	
	Configuration2 reset	Action

Adjustment Item	Problem / Option		Button to Press
OSD turn off	You can set the OSD display duration time between 5 and 120 seconds. Off / 5 - 120 seconds		 
OSD H-Position	OSD is too left OSD is too right		   
OSD V-Position	OSD is too low OSD is too high		   
Information OSD	Set the period of time the information OSD is displayed on the upper right corner of the screen. Off / 1 - 60 seconds		 
Logo	Off	iiyama Logo does not display when the display is turned on.	
	On	iiyama Logo displayed when the display is turned on.	
	User	Custom logo option in android is set, there will be only custom logo when the display is turned on.	
Monitor ID	Set ID to the display. 1 - 255		
Heat status	Display the thermal status.		
Monitor information	Shows information about your display, including Model name, Serial No., Operation hours and SW version.		
HDMI Version*	Set the version of the HDMI. 1.4 / 2.0		
Configuration2 reset	Cancel	Return to Menu.	
	Reset	Configuration2 setting will be restored to factory-preset data.	

* Suitable for HDMI input only.

Advanced option

Picture	IR control	Unlock
Screen	Power LED Light	On
Audio	Keyboard control	Unlock
Configuration1	Off timer	Off
Configuration2	Date and time	Action
Advanced option	Schedule	Action
	HDMI with One Wire	Off
	Language	English
	OSD transparency	Off
	Power Save	Mode1
	OPS settings	Auto
	Advanced option reset	Action

Adjustment Item	Problem / Option		Button to Press
IR control	Select the operation mode of the remote control when multiple displays are connected via an RS232C connection.		
	Unlock* ¹	Unlock the remote control.	
	Lock All	Lock all of the remote control.	
	Lock all but Volume	Lock all except the volume of the remote control.	
	Lock all but Power	Lock all except the power of the remote control.	
	Lock all except PWR & VOL	Lock all except the volume and power of the remote control.	
	Primary	Set the display as the primary display for remote control operation.	
	Secondary	Set the display as the secondary display. This display can not be operated by the remote control, and will only receive the control signal from the primary display via the RS232C connection.	
Power LED light	Off	The Power Indicator is turned Off.	
	On	The Power Indicator is turned On.	
Keyboard control	Lock the keyboard function. (Control buttons)		
	Unlock* ²	Unlock the keyboard.	
	Lock All	Lock all of the keyboard.	
	Lock all but Volume	Lock all except the volume of the keyboard.	
	Lock all but Power	Lock all except the power of the keyboard.	
	Lock all except PWR & VOL	Lock all except the volume and power of the keyboard.	
Off Timer	Set when turn off the display. Off / 1 - 24 hours		
Date and time	Adjust the current date and time for the internal clock. Auto sync(automatically) / Set Date / Set Time NOTE You must set this item when using "Schedule".		

*¹ To unlock, press and hold the INFO button on the remote control for 6 seconds.

*² To unlock, hold the + button and ▲ button on the monitor for more than 3 seconds, it will lock/unlock the control button function.

Advanced option

Picture	IR control	Unlock
Screen	Power LED Light	On
Audio	Keyboard control	Unlock
Configuration1	Off timer	Off
Configuration2	Date and time	Action
Advanced option	Schedule	Action
	HDMI with One Wire	Off
	Language	English
	OSD transparency	Off
	Power Save	Mode1
	OPS settings	Auto
	Advanced option reset	Action

Adjustment Item	Problem / Option		Button to Press
Schedule	Schedule list		Up to 7 schedules can be set.
	Schedule 1/2/3/4/ 5/6/7	Enable	Enable / disable schedule. NOTE If set with other schedule list conflict, you can not enable schedule.
		Start time	Set start time.
		End time	Set end time.
		Input	Select default input source to use when the display is automatically turned on next time. HDMI1 / HDMI2 / HDMI3 / HDMI4 / DisplayPort / VGA / OPS* ⁵ / Mediaplayer / Browser / CMS / PDF player / Custom
		Playlist 1/2/3/4/5/6/7	Choose playlist (1 - 7) for the mediaplayer, PDF player and browser.
		Days of the week	Set the day of the week. Sun / Mon / Tue / Wed / Thu / Fri / Sat
		Every week	Set whether to repeat every week.
	Back	Does not change schedule data.	
	Save	Save schedule data.	
HDMI with One Wire* ³	Off	HDMI with One Wire is turned Off.	
	On	Enable CEC.* ⁴	
Language	English	English	Español Spanish
	Deutsch	German	Русский Russian
	Français	French	Polski Polish
	Italiano	Italian	Nederlands Dutch
OSD Transparency	The background of OSD is made transparent. Off / 1 - 100		

*³ It can be used only when HDMI is connected with equipment compatible with CEC function.

*⁴ CEC (Consumer Electronics Control) is a link function that operates each other by exchanging control signals between devices such as display and recorder.

*⁵ It can be used only when OPS is installed.

Advanced option

Picture	IR control	Unlock
Screen	Power LED Light	On
Audio	Keyboard control	Unlock
Configuration1	Off timer	Off
Configuration2	Date and time	Action
Advanced option	Schedule	Action
	HDMI with One Wire	Off
	Language	English
	OSD transparency	Off
	Power Save	Mode1
	OPS settings	Auto
	Advanced option reset	Action

Adjustment Item	Problem / Option		Button to Press		
	Power Save		Power button off	No signal	WOL
Mode1		DC off	DC off	On	ARM off
Mode2		Not available on this model.			
Mode3		Backlight off	Backlight off, when signal is back, system wake up	Off	ARM off
Mode4		Backlight off	Backlight on, show "no signal"	Off	ARM off
OPS settings* ⁶	Auto	When turning on the display power and switching input source to OPS, OPS power is automatically turned on.			
	Always off	OPS is always turned Off.			
	Always on	OPS is always turned On.			
Advanced option reset	Cancel	Return to Menu.			
	Reset	Advanced option setting will be restored except "Date and Time" in the Advanced option menu to factory-preset data.			

*⁶ When "Power save" is set to Mode 3 or Mode 4, the backlight turns off but OPS keeps on state.

APPLICATION

Press the  HOME button and number 1668 on the remote control.

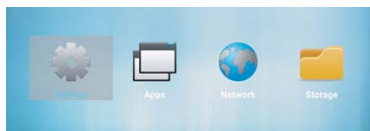

or

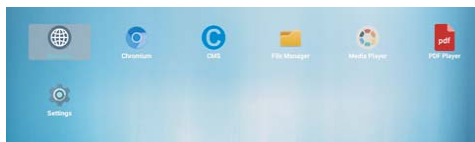

<Settings>

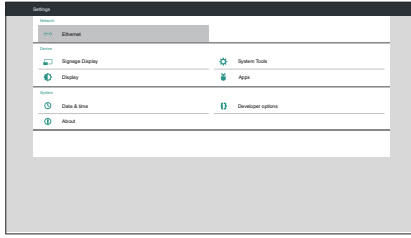

Adjustment Item	Problem / Option			
Ethernet	Set the wired network. Disable / Enable(Connection Type: DHCP/Static IP/IP Address/ Netmask/DNS Address/Gateway, MAC Address)			
Signage Display	General settings	Signage Display name	Set the display name Ethernet Mac Address.	
		Boot Logo*	Disable / Enable(Select Boot Animation)	
		Screenshot	Disable / Enable(Interval, Start time, End time, Repeat, Save to, Purge Screenshots, Send screenshots via email)	
	Server settings	Email Notification	Disable / Enable(SMTP, Manager Email, Test)	
		FTP	Disable / Enable(Account, Password, Storage Path, Port)	
		SICP Network Port	Change the SICP Network Port.	
	Source settings	Media Player	Edit Media Player playlist and effect settings.	
		Browser	Edit Bookmark configuration.	
		CMS	Set the CMS.	
		PDF Player	Edit PDF Player playlist and effect settings.	
		Custom App	Edit the Custom App.	
	Security	External Storage	Disable	SD card / USB External Storage unlock.
Enable			SD card / USB External Storage lock.	

* The Boot Logo can not be used when the OSD menu Logo is On or Off in Android settings.

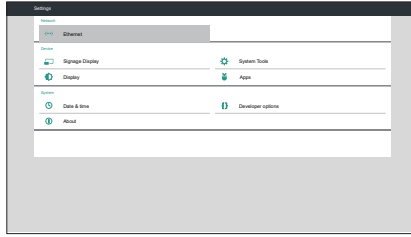

Adjustment Item	Problem / Option		
System Tools	Clear Storage	Clear all data in signage folders. All / Internal storage / USB storage / SD card	
	Factory Reset	Cancel	Return to Menu.
		OK	Factory-preset data is restored.
	Export signage Display setting	Export to signage folder under USB/SD. USB storage / SD card	
	Import signage Display setting	Import to signage folder under USB/SD. USB storage / SD card	
Clone Media File	Copy the media file from internal, USB or SD folder.		
Display	Set the font size. Small / Normal / Large / Huge		
Apps	Display applications information.		
Date & Time	Display Date & Time information.		
Developer options	Set the Android developer option.		
About	Main info in About: System updates / Android version / Kernel version / Build number Automatically search update .zip from USB or SD card. When you select the updated .zip file, the display will restart and the update will start.		

Save: Save
Forget: Delete

Discard: Discard
Cancel: Close without saving

■ Quick Info
Press the Info button and number 77 on the remote control.
Display the Network and Monitor etc. information.

<Android>

- Settings : Go to settings app.
- Apps : Show all apps. (Browser/Chromium/CMS/File Manager/Media Player/PDF player/Settings)
- Network : Set Ethernet.
- Storage : Display current Android storage information.

[Media Player]

- Play: Select playlist to play
- Compose: Edit playlist
- Settings: Setting play properties

■ Supported file format:

- Music: MP3, WMA, WMA pro, M4A, AAC, LPCM
- Video: AVI, MP4, 3GPP, MKV, ASF, VRO VOB, PS, TS
- Photo: JPEG, BMP, PNG, GIF

● Play

Select "Play" on the page. First you select one playlist to play between FILE1 and FILE7.

■ Media Hotkey





- ► **Play**: To play the media file.
- || **Pause**: To pause the media file.
- ►► **Fast forward**: To skip forward 20 seconds.
- ◀◀ **Rewind**: To skip backward 20 seconds.
- ■ **Stop**: To stop the media file. If it is a gif file, it will pause.

● Compose

1. Select "Compose" on the page. First you select one playlist to play between FILE1 and FILE7.
2. Select the file and select edit or delete.
3. Save the edited file.
 - videos in /root/signage/video/
 - photos in /root/signage/photo/
 - music in /root/signage/music/
4. When you create photo list you will be asked if you want to play back ground music during slideshow playback. Set as required.

■ Slide bar

- **Source**: Select storage (USB/SD card)
- **Playlist**: Show playlist (Internal)
- **Select all**: Select all storage files.
- **Delete all**: Delete playlist files.
- **Add/Remove**: Update playlist from the source.
- **Sort**: Sort playlist.
- **Save/Abort**: Save or abort playlist.
- **Back**: Return.

- Remote control
 -  **Option key:** Display sidebar
 -  **Play key:** Play media file
 -  **Pause key:** Pause
 -  **Info key:** Show media info
 -  **OK key:** Select / deselect file

- **Settings**

Select "Settings" on the page.

- **Repeat mode:** Play mode.
 - Repeat once: All files are repeated once.
 - Repeat all: All files in the same folder play repeatedly.
- **Slideshow Effect:** Photo slideshow effect.
 - Right to left: Change from right to left sliding.
 - Fold: Change by rotating horizontally in the center.
 - Corner: Change by enlarging from the upper left corner to the lower right corner.
 - None: Normal
- **Effect Duration:** Photo effect duration. 5s/10s/15s/20s

[Browser]

- **Settings**

Select "Settings" on the page.

- Set frequently used URL.
 1. Select 1 - 7.
 2. Enter URL and press OK.
 3. Press 'Option' to display the slide bar.
 - Import:** Import URL list file
 - Export:** Export URL list file
 - Delete all:** Delete all URL record
 - Back:** Slide bar will be closed

[PDF Player]

● Play

Select "Play" on the page. First you select one playlist to play between FILE1 and FILE7.

■ Media Hotkey

- **▶ Play:** To play the PDF file.
- **⏸ Pause:** To pause the PDF file.
- **▶▶ Fast forward:** Go to the next page, if the page is end of the file, it will go to next file.
- **◀◀ Rewind:** Back to previous page, if the page is first of the file, it will back to previous file.
- **■ Stop:** Return to first page of file.

■ Color Hotkey

- **Blue key:** Zoom in (+10%)
- **Yellow key:** Zoom out (-10%)
- **Ⓞ OK key:** Restore zoom

■ Arrow key

- **▲ / ▼ / ◀ / ▶ :** Adjust page (When the page has zoomed in/out)
- **◀ :** Previous page (When the page has not zoomed in/out)
- **▶ :** Next page (When the page has not zoomed in/out)

● Compose

1. Select "Compose" on the page. First you select one playlist to play between FILE1 and FILE7.

2. Select the file and select edit or delete.

3. Save the edited file.

-pdfs in /root/signage/video/

■ Slide bar

- **Source:** Select storage (USB/SD card)
- **Playlist:** Show playlist (Internal)
- **Select all:** Select all storage files.
- **Delete all:** Delete playlist files.
- **Add/Remove:** Update playlist from source.
- **Sort:** Sort playlist.
- **Save/Abort:** Save or abort playlist.
- **Back:** Return.

■ Remote control

- **☰ Option key:** Display sidebar
- **▶ Play key:** Play media file
- **ⓘ Info key:** Show media info
- **Ⓞ OK key:** Select / deselect file

● Settings

Select "Settings" on the page.

- **Repeat mode:** Play mode.

Repeat once: All files are repeated once.

Repeat all: All files in the same folder play repeatedly.

- **Effect Duration:** PDF effect duration. 5s/10s/15s/20s

[CMS]

Set the Server/Account/PIN code/Version(Ver.2/Ver.3)*/Content(Internal storage/USB storage/SD card).

* When Ver.2, Server/Account/PIN code will be gray and unavailable.

When Ver.3, Server/Account/PIN code is available.

[Chromium]

Connect the network, and browse the web.

[File Manager]

Browse the files stored in the internal storage, USB and SD card.

[Settings]

See page 34,35 for Settings.

[Custom]

Set up the application for Customer Source.

- NOTE**
- Only display user installed app.
 - Will not appear in the system pre-install app.

SCREEN ADJUSTMENTS

Adjust the image by following the procedure below to get the desired picture when selecting Analog input.

- The screen adjustments described in this manual are designed to set image position and minimize flicker or blur for the particular computer in use.
- The monitor is designed to provide the best performance at resolution of 3840 × 2160, but can not provide the best at resolutions of less than 3840 × 2160 because the picture is automatically stretched to fit the full screen. It is recommended to operate at resolution of 3840 × 2160 in normal use.
- Displayed text or lines will be blurred or irregular in thickness when the picture is stretched due to the screen enlargement process.
- It is preferable to adjust the image position and frequency with the monitor controls, rather than the computer software or utilities.
- Perform adjustments after a warm-up period of at least thirty minutes.
- Additional adjustments may be required after the Auto Adjust depending on the resolution or signal timing.
- The Auto Adjust may not work correctly when displaying the picture other than the screen adjustment pattern. In this case, manual adjustments are required.

There are two ways to adjust the screen. One way is automatic adjustment for Position, Clock and Phase. The other way is performing each adjustment manually.

Perform the Auto Adjust first when the monitor is connected to a new computer, or resolution is changed. If the screen has a flicker or blur, or the picture does not fit in the display area after performing the Auto Adjust, manual adjustments are required. Both adjustments should be made by using the screen adjustment pattern (Test.bmp) obtained via the Iiyama web site (<http://www.iiyama.com>).

Adjust the image by following the procedure below to get the desired picture.

This manual explains adjustment under Windows® OS.

- ① **Display the picture at the optimum resolution.**
- ② **Enter the Test.bmp (screen adjustment pattern) to wallpaper.**

NOTE

- Consult the appropriate documentation for doing this.
- Test.bmp is made at resolution of 1280 × 1024. Set the display position to center in the wallpaper setting dialogue box.

[Adjustment pattern]

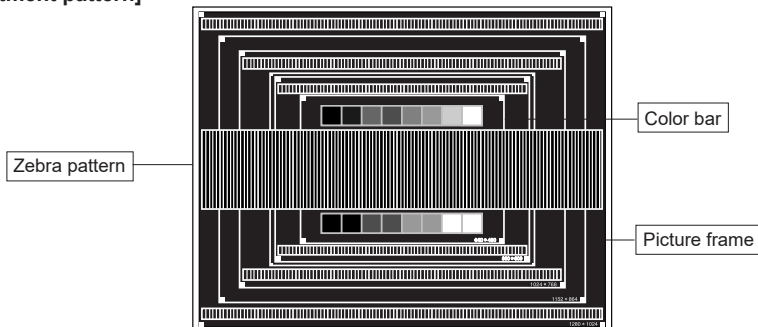

- ③ Adjust the Auto Adjustment. (Auto Adjust)
- ④ Adjust the image manually by following procedure below when the screen has a flicker or blur, or the picture does not fit in the display area after performing the Auto Adjust.
- ⑤ Adjust the V.Position so that the top and bottom of the picture frame will fit to the display area.

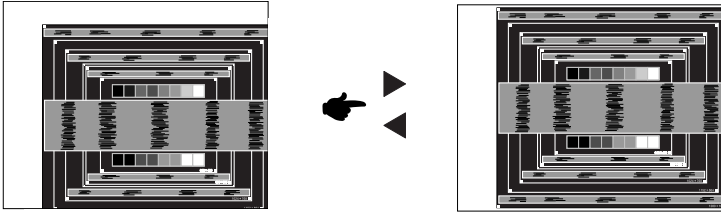

- ⑥ 1) Adjust the H.Position so that the left side of the picture frame will move to the left edge of the display area.

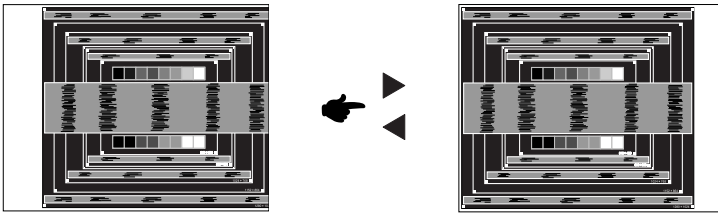

- 2) Stretch the right side of the picture frame to the right edge of the display area by adjusting the Clock.

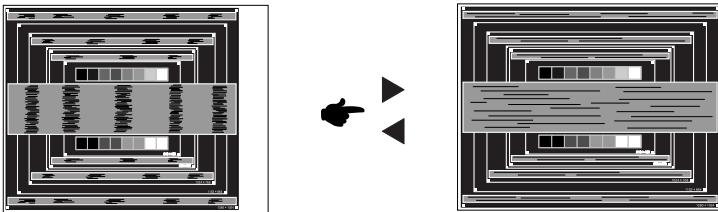
**NOTE**

- When the left side of the picture frame moves apart from the left edge of the display area during the Clock adjustment, adjust steps 1) and 2).
- Another way to make the Clock adjustment is to correct the vertical wavy lines in the zebra pattern.
- The picture may flicker during the Clock, H.Position and V.Position adjustment.
- In case the picture frame is bigger or smaller than the data display area after the Pixel Clock adjustment, repeat steps from ③.

- ⑦ **Adjust the Phase to correct horizontal wavy noise, flicker or blur in the zebra pattern.**

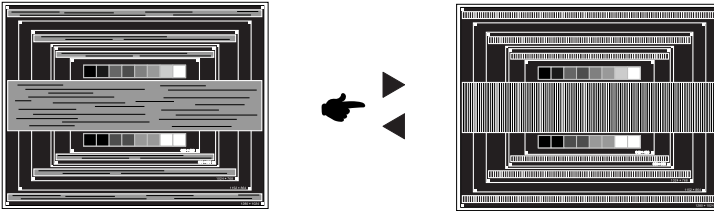

NOTE

- In case the strong flicker or blurs remain on a part of the screen, repeat steps ⑥ and ⑦ because the Clock may not be adjusted correctly.
- Adjust the H.Position after the Phase adjustment if the horizontal position moves during the adjustment.

- ⑧ **Adjust the Brightness and Color to get the desired picture after you complete the Clock and Phase adjustments.**

Put back your favorite wallpaper.

POWER MANAGEMENT FEATURE

The power management feature of this product complies with power saving requirement of VESA DPMS. When activated, it automatically reduces unnecessary power consumption of the display when your computer is not in use.

To use the feature, the display needs to be connected to a VESA DPMS compliant computer. There is a power management step the display takes as described below. The power management function, including any timer settings is configured by the operating system. Check your operating system manual for information on how this can be configured.

■ Power Management Mode

When the H-sync signal / V-sync signal / H and V sync signals from the computer are off, the display enters into Power Management Mode which reduces the power consumption to less than 0.5W. The screen becomes dark. From Power Management Mode, the image reappears in several seconds when either the keyboard or the mouse are touched again.

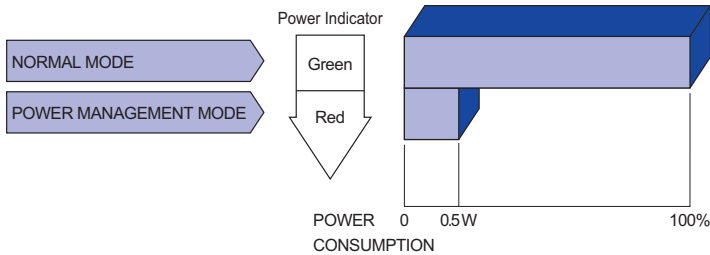

NOTE

- Even when using the power management mode, the display consumes electricity. Turn off the Power Switch whenever the display is not in use, during the night and weekends, to avoid unnecessary power consumption.
- It is possible that the video signal from the computer may be on while the H or V sync signal is missing. In this instance, the POWER MANAGEMENT feature may not work properly.

TROUBLE SHOOTING

If the display fails to operate correctly, please follow the steps below for a possible solution.

1. Perform the adjustments described in OPERATING THE DISPLAY, depending on the problem you have. If the display does not get a picture, skip to 2.
2. Consult the following items if you cannot find an appropriate adjustment item in OPERATING THE DISPLAY or if the problem persists.
3. If you are experiencing a problem which is not described below or you cannot correct the problem, discontinue using the display and contact your dealer or iiyama service center for further assistance.

Problem

Check

- | | |
|---|--|
| ① The picture does not appear. | <input type="checkbox"/> The Power Cable is firmly seated in the socket.
<input type="checkbox"/> The Power Switch is turned ON.
<input type="checkbox"/> The AC socket is live. Please check with another piece of equipment.
<input type="checkbox"/> If the blank screen saver is in active mode, touch the keyboard or the mouse.
<input type="checkbox"/> Increase the Contrast and/or Brightness.
<input type="checkbox"/> The computer is ON.
<input type="checkbox"/> The Signal Cable is properly connected.
<input type="checkbox"/> The signal timing of the computer is within the specification of the display.
<input type="checkbox"/> If the display is in power management mode, touch the keyboard or the mouse. |
| ② The screen is not synchronized. | <input type="checkbox"/> The Signal Cable is properly connected.
<input type="checkbox"/> The signal timing of the computer is within the specification of the display.
<input type="checkbox"/> The video output level of the computer is within the specification of the display. |
| ③ The screen position is not in the center. | <input type="checkbox"/> The signal timing of the computer is within the specification of the display. |
| ④ The screen is too bright or too dark. | <input type="checkbox"/> The video output level of the computer is within the specification of the display. |
| ⑤ The screen is shaking. | <input type="checkbox"/> The power voltage is within the specification of the display.
<input type="checkbox"/> The signal timing of the computer is within the specification of the display. |
| ⑥ No sound. | <input type="checkbox"/> The audio equipment (computer etc.) is ON.
<input type="checkbox"/> The Audio Cable is properly connected.
<input type="checkbox"/> The Volume is turned up.
<input type="checkbox"/> The Mute is OFF.
<input type="checkbox"/> The audio output level of the audio equipment is within the specification of the display. |
| ⑦ The sound is too loud or too quiet. | <input type="checkbox"/> The audio output level of the audio equipment is within the specification of the display. |
| ⑧ A strange noise is heard. | <input type="checkbox"/> The Audio Cable is properly connected. |

RECYCLING INFORMATION

For better environment protection please don't dispose your display.
Please visit our web site: www.iiyama.com/recycle for monitor recycling.

APPENDIX

Design and specifications are subject to change without prior notice.

SPECIFICATIONS : ProLite LE7540UHS

ENGLISH

Size Category		75"
LCD Panel	Panel technology	IPS
	Size	Diagonal: 74.5" (189cm)
	Pixel pitch	0.429mm H × 0.429mm V
	Brightness	410cd/m ² (Typical)
	Contrast ratio	1200 : 1 (Typical)
	Viewable angle	Horizontal : 178 degrees, Vertical: 178 degrees (Typical)
	Response time	8ms (Typical, Gray to Gray)
Display Colors		Approx.16.7M
Sync Frequency		Analog: Horizontal: 30.0-83.0kHz, Vertical: 50-76Hz Digital: Horizontal: 30.0-83.0kHz, Vertical: 50-76Hz
Native Resolution		3840 × 2160, 8.3 MegaPixels
Support Max. Resolution		VGA: 1920 × 1080 60Hz HDMI: 3840 × 2160 60Hz DisplayPort: 3840 × 2160 30Hz
Input Connector		VGA, HDMI × 4, DisplayPort
Input Audio Connector		mini jack
LAN		RJ45
Serial Port		RS-232C In/Out mini jack
Plug & Play		VESA DDC2B™
Input Sync Signal		Separate sync: TTL, Positive or Negative
Input Video Signal		Analog: 0.7Vp-p (Standard), 75Ω, Positive Digital: HDMI, DisplayPort
Input Audio Signal		0.5Vrms maximum
IR Extender Connector		IR In/Out
USB Connector		USB2.0 (USB Media Player) × 1, USB3.0 (USB Media Player) × 1, 5V2A (USB power charging) × 1, 5V5A × 1
Micro SD card slot		Micro SD
Output Audio Connector		RCA(L/R)
Speakers		Internal: 10W×2 (Stereo speakers)
Maximum Screen Size		1649.6mm W × 927.9mm H / 64.9" W × 36.5" H
Power Source		100-240VAC, 50/60Hz, 5A
Power Consumption*		220W typical, Power management mode: 0.5W maximum Energy Efficiency Class: B
Dimensions / Net Weight		1676.5 × 955.5 × 63.0mm / 66.0 × 37.6 × 2.5" (W×H×D) 53.3kg / 117.5lbs
Environmental Considerations		Operating: Temperature 0 to 40°C / 32 to 104°F Humidity 20 - 80% (No condensation) Storage: Temperature -20 to 60°C / 4 to 140°F Humidity 5 - 95% (No condensation)
Approvals		CB, CE, CU, TÜV-Bauart

NOTE * USB peripherals / Audio equipment are not connected.

SPECIFICATIONS : ProLite LE8640UHS

Size Category	86"	
LCD Panel	Panel technology	IPS
	Size	Diagonal: 85.6" (217cm)
	Pixel pitch	0.4935mm H × 0.4935mm V
	Brightness	410cd/m ² (Typical)
	Contrast ratio	1200 : 1 (Typical)
	Viewable angle	Horizontal : 178 degrees, Vertical: 178 degrees (Typical)
	Response time	8ms (Typical, Gray to Gray)
Display Colors	Approx.16.7M	
Sync Frequency	Analog: Horizontal: 30.0-83.0kHz, Vertical: 50-76Hz Digital: Horizontal: 30.0-83.0kHz, Vertical: 50-76Hz	
Native Resolution	3840 × 2160, 8.3 MegaPixels	
Support Max. Resolution	VGA: 1920 × 1080 60Hz HDMI: 3840 × 2160 60Hz DisplayPort: 3840 × 2160 30Hz	
Input Connector	VGA, HDMI × 4, DisplayPort	
Input Audio Connector	mini jack	
LAN	RJ45	
Serial Port	RS-232C In/Out mini jack	
Plug & Play	VESA DDC2B™	
Input Sync Signal	Separate sync: TTL, Positive or Negative	
Input Video Signal	Analog: 0.7Vp-p (Standard), 75Ω, Positive Digital: HDMI, DisplayPort	
Input Audio Signal	0.5Vrms maximum	
IR Extender Connector	IR In/Out	
USB Connector	USB2.0 (USB Media Player) × 1, USB3.0 (USB Media Player) × 1, 5V2A (USB power charging) × 1, 5V5A × 1	
Micro SD card slot	Micro SD	
Output Audio Connector	RCA(L/R)	
Speakers	Internal: 10W×2 (Stereo speakers)	
Maximum Screen Size	1895.0mm W × 1065.9mm H / 74.6" W × 42.0" H	
Power Source	100-240VAC, 50/60Hz, 6A	
Power Consumption*	290W typical, Power management mode: 0.5W maximum Energy Efficiency Class: B	
Dimensions / Net Weight	1928.0 × 1099.0 × 76.5mm / 75.9 × 43.3 × 3.0" (W×H×D) 63.8kg / 140.6lbs	
Environmental Considerations	Operating: Temperature 0 to 40°C / 32 to 104°F Humidity 20 - 80% (No condensation) Storage: Temperature -20 to 60°C / 4 to 140°F Humidity 5 - 95% (No condensation)	
Approvals	CB, CE, CU, TÜV-Bauart	

NOTE * USB peripherals / Audio equipment are not connected.

DIMENSIONS : ProLite LE7540UHS

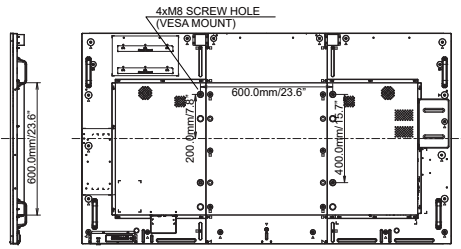
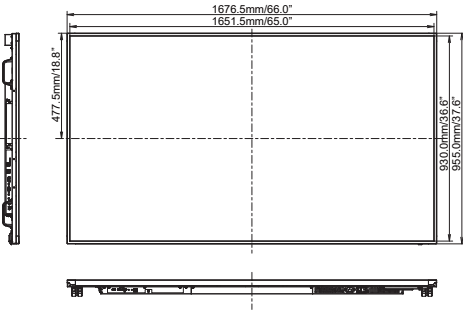
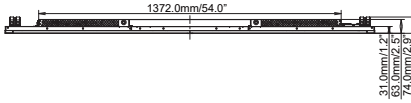

DIMENSIONS : ProLite LE8640UHS

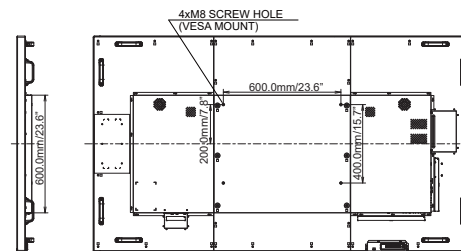
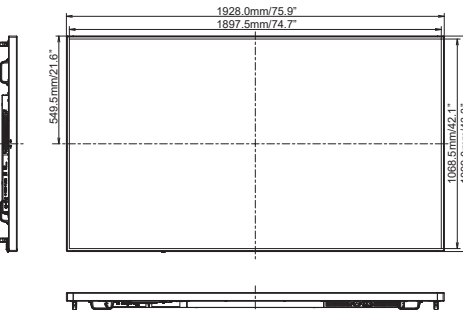
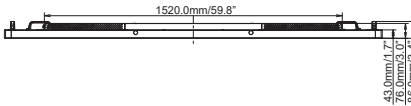

ENGLISH

COMPLIANT TIMING

Timing		fH(kHz)	FV(Hz)	Dot clock (MHz)	VGA	HDMI1	HDMI2	HDMI3	HDMI4	DisplayPort
VESA	VGA 640x480	31.5	60.0	25.175	○	○	○	○	○	○
	SVGA 800x600	37.9	60.0	40.000	○	○	○	○	○	○
	XGA 1024x768	48.4	60.0	65.000	○	○	○	○	○	○
	WXGA 1280x768	47.8	60.0	79.500	○	○	○	○	○	○
	QVGA 1280x960	60.0	60.0	108.000	○	○	○	○	○	○
	SXGA 1280x1024	64.0	60.0	108.000	○	○	○	○	○	○
	HD FWXGA 1366x768	47.7	60.0	85.500	○	○	○	○	○	○
	CVT 1400x900	55.9	60.0	106.500	○	○	○	○	○	○
	WSXGA 1680x1050	65.3	60.0	146.250	○	○	○	○	○	○
	FHD 1920x1080	67.5	60.0	148.500	○	○	○	○	○	○
4K 3840x2160	67.5	30.0	297.000		○	○	○	○		
	112.5	50.0	594.000		○	○	○	○		
	135.0	60.0	594.000		○	○	○	○		
IBM	720x400	31.5	70.0	28.320	○	○	○	○	○	
SD	NTSC-M	15.7	60.0	13.500						
	NTSC-J	15.7	60.0	13.500						
	PAL-BDGIH	15.7	60.0	13.500						
	480i	60Hz	15.7	60.0	13.500		○	○	○	○
	576i	50Hz	15.6	50.0	13.500		○	○	○	○
	480p	60Hz	31.5	60.0	27.000		○	○	○	○
	576p	50Hz	31.3	50.0	27.000		○	○	○	○
HD	720p	50Hz	37.5	50.0	74.250		○	○	○	○
		60Hz	45.0	60.0	74.250		○	○	○	○
	1080i	50Hz	28.1	50.0	74.250		○	○	○	○
		60Hz	33.8	60.0	74.250		○	○	○	○
	1080p	50Hz	56.3	50.0	148.500		○	○	○	○
		60Hz	67.5	60.0	148.500		○	○	○	○

* ○ means supported the timing.