

This product is intended for installation only by expert users. Please consult with a qualified technician for installation. Improper installation may result in damage to your equipment. EK Water Blocks assumes no liability whatsoever, expressed or implied, for the use of these products, nor their installation. The following instructions are subject to change without notice. Please visit our web site at www.ekwb.com for updates. Before installation of this product please read important notice, disclosure and warranty conditions printed on the back of the box.

Before you start using this product please follow these basic guidelines:

1. Please carefully read the manual before through before beginning with the installation process!
2. Please remove your motherboard from the computer to assure safest mounting process in order to prevent any possible damages to your CPU and/or motherboard.
3. The EK High Flow and EK-CSQ type fittings require only a small amount of force to screw them firmly in place since the liquid seal is ensured by the rubber O-ring gaskets.
4. The use of corrosion inhibiting coolants is always recommended for any liquid cooling system.

STEP 1: GENERAL INFORMATION. Sample picture of GeForce GTX 980 G1 Gaming series graphics

STEP 2: PREPARING YOUR GRAPHIC CARD.

1. REMOVING STOCK COOLER: Remove encircled screws on the backside of the graphics card.

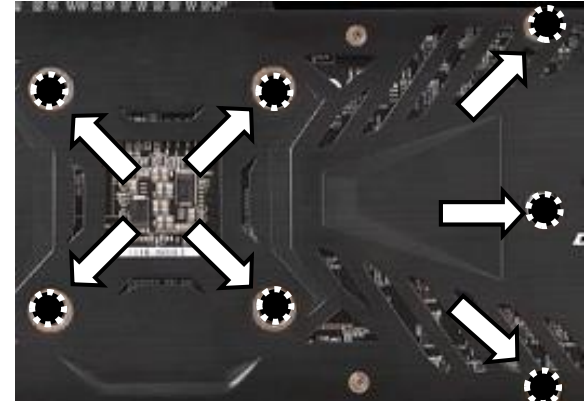

STEP 2 cont.: PREPARING YOUR GRAPHIC CARD

1 cont.. REMOVING STOCK COOLER. Remove the stock GPU HSF and backplate assembly. Remove all encircled screws attaching the backplate and VRM heatsink to the circuit board.

2. CLEANING THE PCB. Carefully detach the original stock cooler after removing **all** screws securing it to the board. Wipe off the remains (by using non-abrasive cloth or *q-tip*, as shown on sample photo) of the original thermal compound until the components and circuit board are completely clean. EKWB recommends the use of denatured alcohol for removing TIM leftovers.

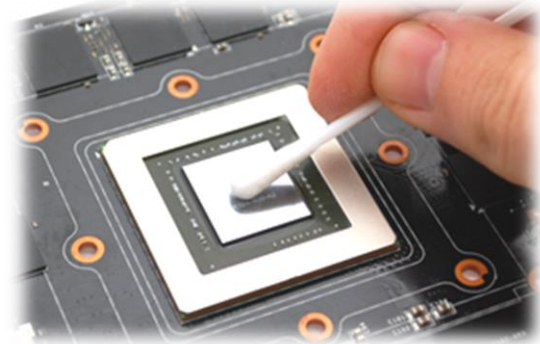
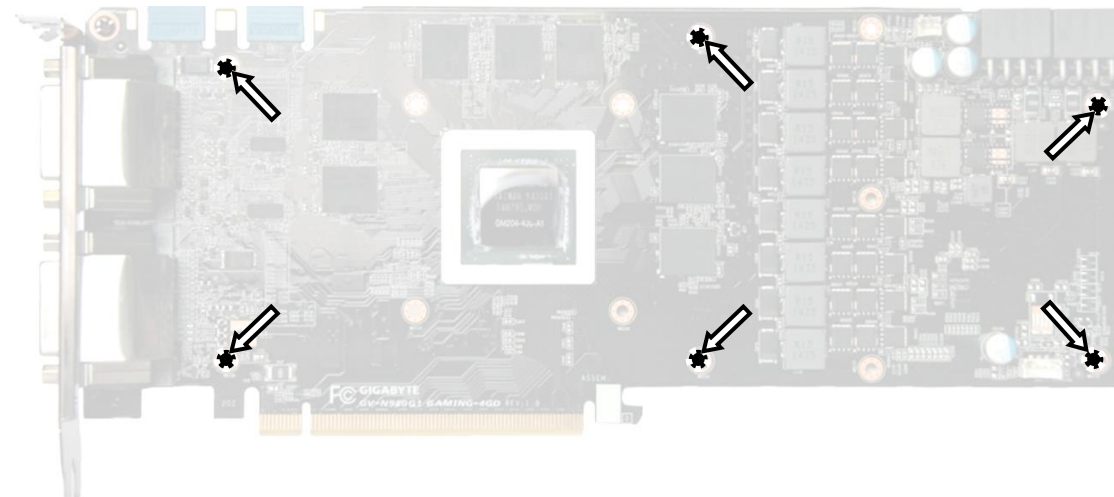

3. APPLYING THERMAL COMPOUND. Wipe off the remains (by using non-abrasive cloth or *q-tip*) of the original thermal compound until the components and circuit board are completely clean. Apply thermal compound: lightly coat **NVIDIA** GPU chip with enclosed EK-TIM Ectotherm thermal grease. EKWB recommends to apply thermal grease in cross form for best performance (see sample picture).

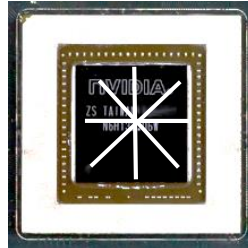

4. CUTTING THERMAL PADS. Your block comes with thermal pads, some of which are already pre-cut. Others have to be cut to smaller chunks in order to cover all the VRM components such as MOSFETs and drivers. PLEASE REMOVE THE PROTECTIVE FOIL FROM BOTH SIDES OF THE THERMAL PADS PRIOR TO INSTALLATION. Replacement thermal pads: Thermal Pad D – 0.5mm (RAM 8x), Thermal Pad A – 0.5mm (100x16mm), Thermal pad A – 1mm (100x16mm).

- 1: Thermal pad D – 0.5 mm (for memory IC):
- 2: Thermal pad A – 0.5 mm (for main VRM/MOSFET):
- 3: Thermal pad A – 1 mm (for main VRM/MOSFET):

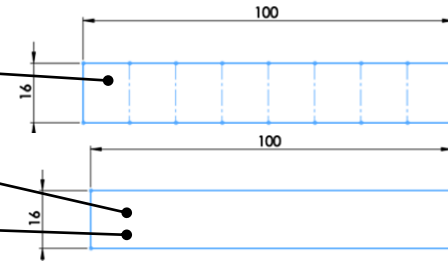

STEP 3: INSTALLING THE WATER BLOCK

1. PLACING THERMAL PADS ON PCB. Place thermal pads on chips so that numbers on chips match size of thermal pads. EKWB made sure users have more than enough pads to cover all surfaces that need to be covered to make block fully functional). EKWB recommends using small drops of electrically non-conductive (for example: EK-TIM Ectotherm, Arctic Cooling MX-2™, -4 MX™ or G-E & I D e U €™) thermal grease on each phase regulator (that is being covered with thermal pad) in order to even further improve the thermal performance of the EK-FC980 GTX WF3 series water block.

2. PLACING THE BLOCK ON TO THE GRAPHICS CARD. Carefully position the water block with preinstalled 2.5mm standoffs on to the graphics card. During this process please make sure you align mounting holes on the PCB with holes on the water block (same applies for other tops). Also pay attention not to use too much force by pressing the block down to the PCB. Chip dies are prone to cracking.

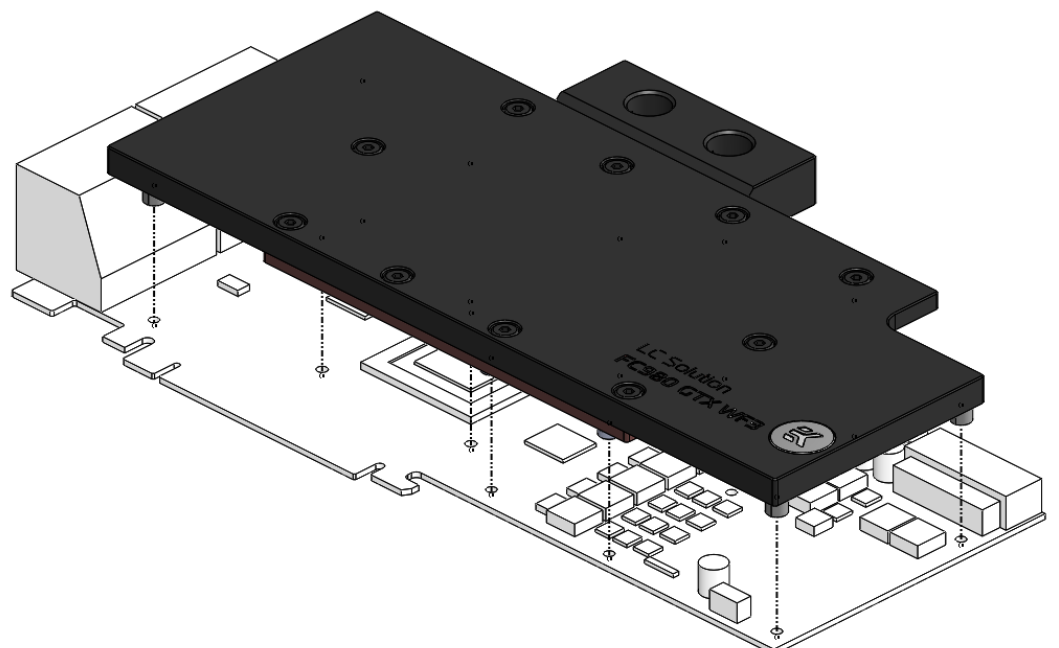
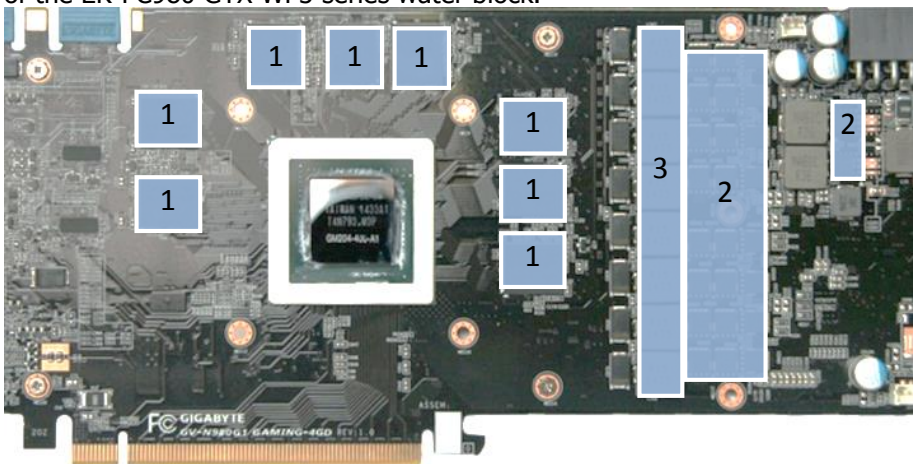

3. ATTACHING THE BLOCK TO THE GRAPHIC CARD. Use a Philips screwdriver with the enclosed M2,5x4 DIN 7985 screws and PVC washers. EKWB recommends users to start tightening the screws around the GPU core and continue outwards. At short top version (plexi) the encircled screws are to be left out.

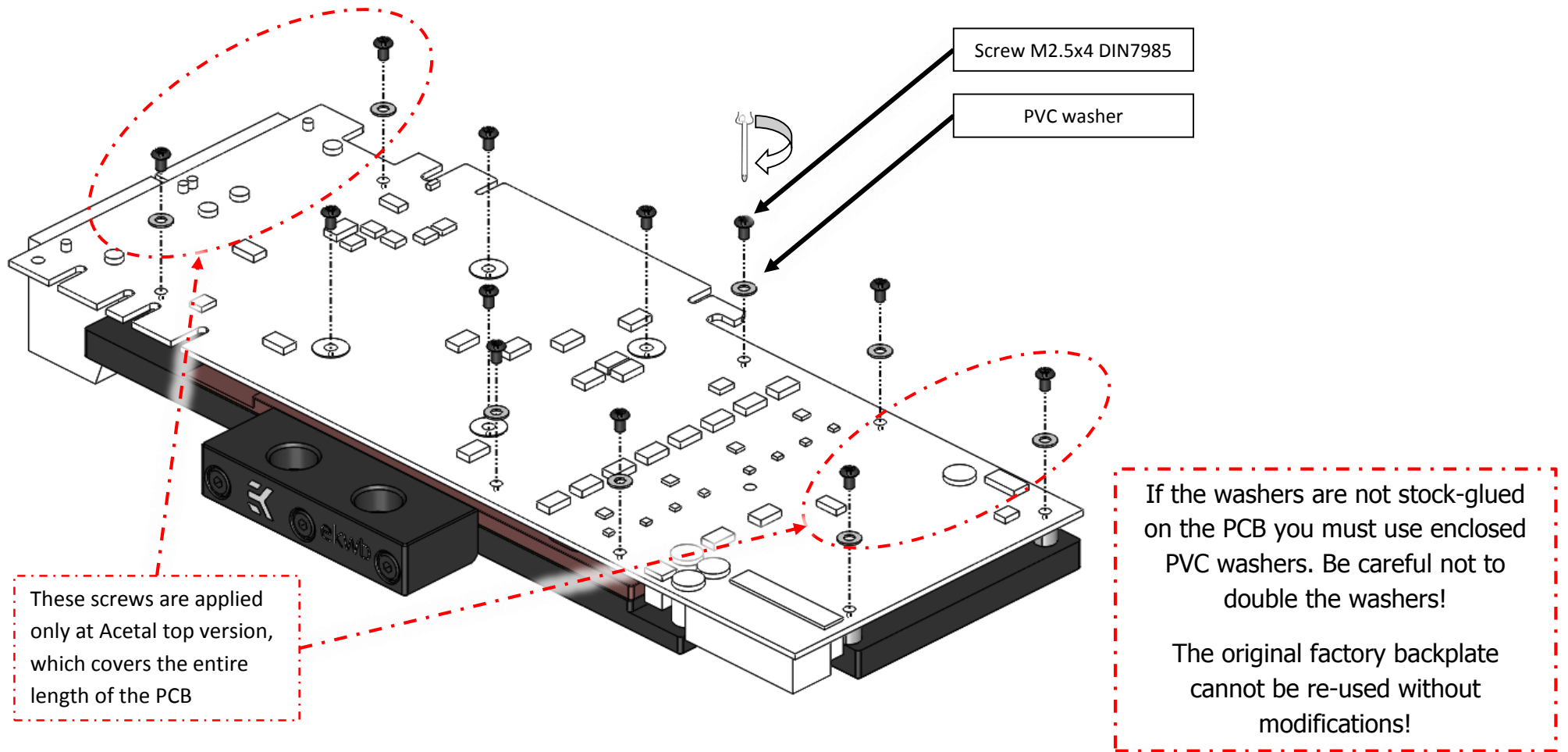

STEP 4: CHECKING FOR CONTACTS

If necessary temporarily remove the water block to check for uniform surface contact between the block and the components, pay special attention to the VRM section of the graphics card. Check whether the water block makes contact with the intended integrated circuit. Then repeat sub-steps in previous section to re-attach the block. **In case you fail to obtain good contact, please check again that your thermal pad thickness or contact our support service at <http://www.ekwb.com/support>.**

STEP 5: INSTALLATION OF FITTINGS AND TUBING

Screw in the two G1/4 threaded male fittings. Attach the liquid cooling tubes and connect the water-block(s) into the cooling circuit. **EKWB recommends using EK-CSQ fittings with the EK-FC980 GTX WF3 series water blocks.** To ensure that the tubes are securely attached to the barb/fittings, please use hose clamps or an appropriate substitute.

You can use any opening as an inlet/outlet port.

CAUTION: In case of using connectors other than EK-CSQ series compression fittings, take special attention to the length of the fitting 5mm is the maximum allowed G1/4" thread length!

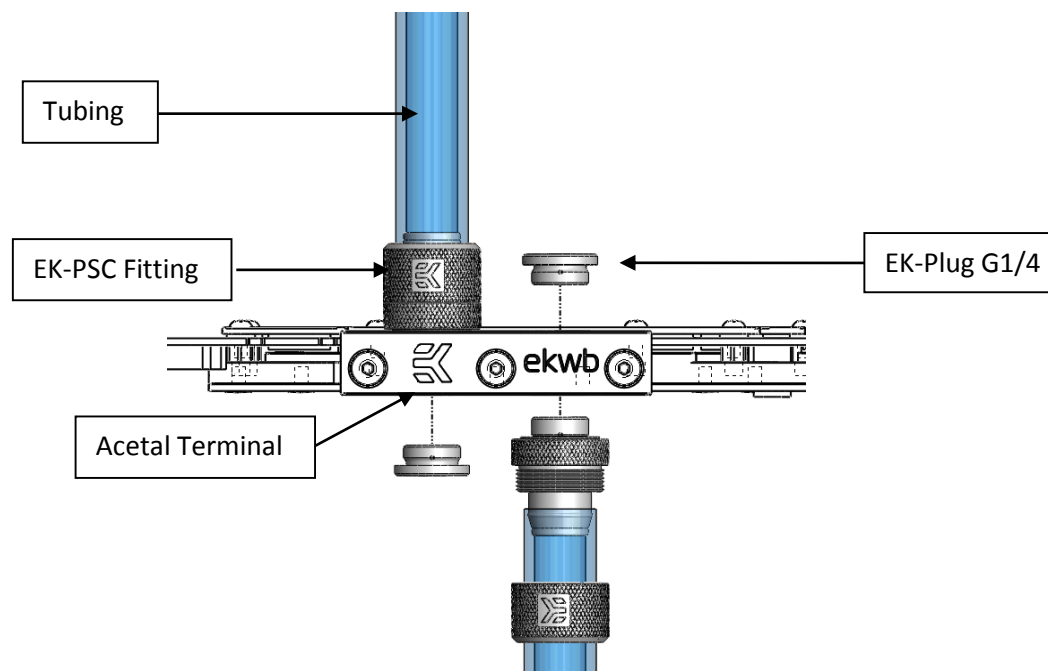

STEP 6: INSERTING THE CARD IN YOUR PC CASE

Carefully lift your graphics card with installed block and ~~expressionslot~~ Please bear in mind that your graphics card is a card probably heavier than when it was equipped with original heat sink fan assembly. One needs to be very careful when handling the graphics card. Avoid all un-needed manipulation of the VGA/water block assembly that might damage your card or water block during final installation.

REQUIRED TOOLS:

